

## IBPS RRB Clerk Mains Maha Mock (Solutions)

**S1. Ans.(e)**

**Sol.** By combining the both I. and II. we know Box T is placed just below the box R.

Boxes
P
U
R
T
Q
S

**S2. Ans.(b)**

**Sol.** Only from II. we get C sits 3<sup>rd</sup> to the right of P.

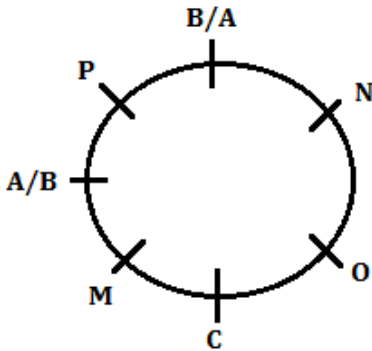

**S3. Ans.(e)**

**Sol.** By combining the both I. and II. "Magician" is written as "jk".

Words	Code
Drop	Fi
Ball	Xc
Magic	Ma
Magician	Jk
Ball/Game	Kt/Pr
Doss	Vh

**S4. Ans.(a)**

**Sol.** Only from I. we get to know that O sits at the right end.

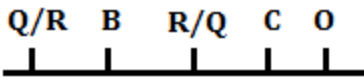

**S5. Ans.(e)**

**Sol.** By combining the both I. and II. we know C likes Purple.

Persons	Colors
A	Blue
C	Purple
F	Black
E	Yellow
B	Green
D	White

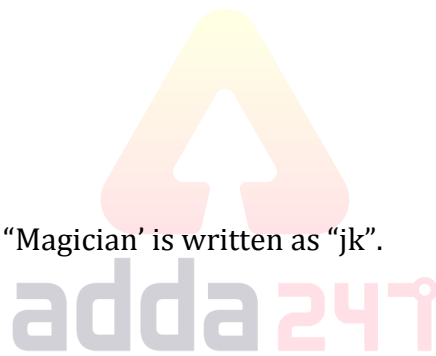

**General Awareness**

Based on GA POWER CAPSULE

IBPS RRB MAINS

**bankersadda.com**

2000 + Questions  
Current Affairs | Banking | Static

S6. Ans.(c)

Sol.

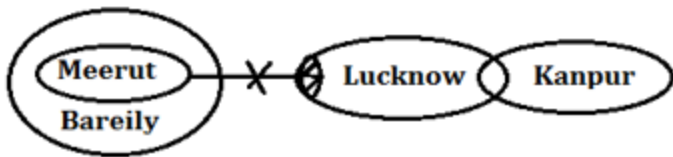

S7. Ans.(a)

Sol.

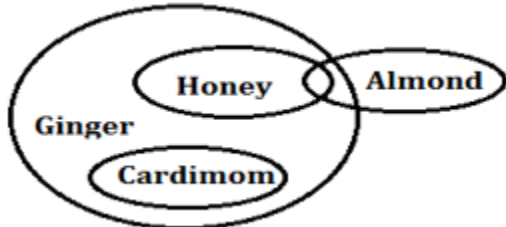

S8. Ans.(c)

Sol.



S9. Ans.(a)

Sol.

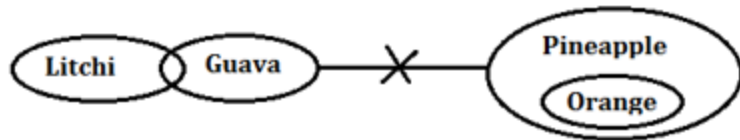

S10. Ans.(c)

Sol.

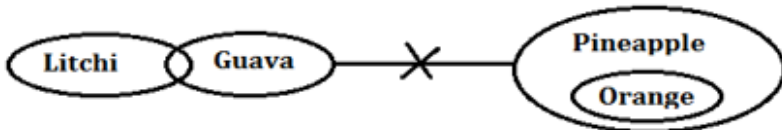

S11. Ans.(c)

Sol. From the given statements, V lives in the East direction with respect to T. One floor gap between V and D, who lives above V's floor in the same flat and also lives on an even number flat. T lives in an odd number flat. Here we get 2 possibilities i.e. Case 1 and Case 2. A lives just above T in same number flat.

Floors/Flats	Case 1			Case 2		
	Flat-1	Flat-2	Flat-3	Flat-1	Flat-2	Flat-3
4		D				
3	A				D	
2	T	V		A		
1				T	V	

From the given statements, Both S and B are living on the same floor with A. Here we get 2 more possibilities i.e. Case 1a and Case 2a. R lives just above the floor in which A lives and in the west of F.

	Case 1			Case 2		
Floors/Flats	Flat-1	Flat-2	Flat-3	Flat-1	Flat-2	Flat-3
4	R	D	F			
3	A	S	B	R	D	F
2	T	V		A	S	B
1				T	V	

	Case 1a			Case 2a		
Floors/Flats	Flat-1	Flat-2	Flat-3	Flat-1	Flat-2	Flat-3
4	R	D	F			
3	A	B	S	R	D	F
2	T	V		A	B	S
1				T	V	

From the given statements, Q lives just above the floor in which C lives. From this condition Case 2 and Case 2a are ruled out. Both S and C are not live in the same flat. Here Case 1a is ruled out now. G lives in the West with respect to E.

So, the final arrangement is such as-

Floors/Flats	Flat-1	Flat-2	Flat-3
4	R	D	F
3	A	S	B
2	T	V	Q
1	G	E	C

### S12. Ans.(b)

**Sol.** From the given statements, V lives in the East direction with respect to T. One floor gap between V and D, who lives above V's floor in the same flat and also lives on an even number flat. T lives in an odd number flat. Here we get 2 possibilities i.e. Case 1 and Case 2. A lives just above T in same number flat.

	Case 1			Case 2		
Floors/Flats	Flat-1	Flat-2	Flat-3	Flat-1	Flat-2	Flat-3
4		D				
3	A				D	
2	T	V		A		
1				T	V	

From the given statements, Both S and B are living on the same floor with A. Here we get 2 more possibilities i.e. Case 1a and Case 2a. R lives just above the floor in which A lives and in the west of F.

	Case 1			Case 2		
Floors/Flats	Flat-1	Flat-2	Flat-3	Flat-1	Flat-2	Flat-3
4	R	D	F			
3	A	S	B	R	D	F
2	T	V		A	S	B
1				T	V	

Floors/Flats	Case 1a			Case 2a		
	Flat-1	Flat-2	Flat-3	Flat-1	Flat-2	Flat-3
4	R	D	F			
3	A	B	S	R	D	F
2	T	V		A	B	S
1				T	V	

From the given statements, Q lives just above the floor in which C lives. From this condition Case 2 and Case 2a are ruled out. Both S and C are not live in the same flat. Here Case 1a is ruled out now. G lives in the West with respect to E.

So, the final arrangement is such as-

Floors/Flats	Flat-1	Flat-2	Flat-3
4	R	D	F
3	A	S	B
2	T	V	Q
1	G	E	C

### S13. Ans.(e)

**Sol.** From the given statements, V lives in the East direction with respect to T. One floor gap between V and D, who lives above V's floor in the same flat and also lives on an even number flat. T lives in an odd number flat. Here we get 2 possibilities i.e. Case 1 and Case 2. A lives just above T in same number flat.

Floors/Flats	Case 1			Case 2		
	Flat-1	Flat-2	Flat-3	Flat-1	Flat-2	Flat-3
4		D				
3	A				D	
2	T	V		A		
1				T	V	

From the given statements, Both S and B are living on the same floor with A. Here we get 2 more possibilities i.e. Case 1a and Case 2a. R lives just above the floor in which A lives and in the west of F.

Floors/Flats	Case 1			Case 2		
	Flat-1	Flat-2	Flat-3	Flat-1	Flat-2	Flat-3
4	R	D	F			
3	A	S	B	R	D	F
2	T	V		A	S	B
1				T	V	

Floors/Flats	Case 1a			Case 2a		
	Flat-1	Flat-2	Flat-3	Flat-1	Flat-2	Flat-3
4	R	D	F			
3	A	B	S	R	D	F
2	T	V		A	B	S
1				T	V	

From the given statements, Q lives just above the floor in which C lives. From this condition Case 2 and Case 2a are ruled out. Both S and C are not live in the same flat. Here Case 1a is ruled out now. G lives in the West with respect to E.

So, the final arrangement is such as-

Floors/Flats	Flat-1	Flat-2	Flat-3
4	R	D	F
3	A	S	B
2	T	V	Q
1	G	E	C

#### S14. Ans.(e)

**Sol.** From the given statements, V lives in the East direction with respect to T. One floor gap between V and D, who lives above V's floor in the same flat and also lives on an even number flat. T lives in an odd number flat. Here we get 2 possibilities i.e. Case 1 and Case 2. A lives just above T in same number flat.

	Case 1			Case 2		
Floors/Flats	Flat-1	Flat-2	Flat-3	Flat-1	Flat-2	Flat-3
4		D				
3	A				D	
2	T	V		A		
1				T	V	

From the given statements, Both S and B are living on the same floor with A. Here we get 2 more possibilities i.e. Case 1a and Case 2a. R lives just above the floor in which A lives and in the west of F.

	Case 1			Case 2		
Floors/Flats	Flat-1	Flat-2	Flat-3	Flat-1	Flat-2	Flat-3
4	R	D	F			
3	A	S	B	R	D	F
2	T	V		A	S	B
1				T	V	

	Case 1a			Case 2a		
Floors/Flats	Flat-1	Flat-2	Flat-3	Flat-1	Flat-2	Flat-3
4	R	D	F			
3	A	B	S	R	D	F
2	T	V		A	B	S
1				T	V	

From the given statements, Q lives just above the floor in which C lives. From this condition Case 2 and Case 2a are ruled out. Both S and C are not live in the same flat. Here Case 1a is ruled out now. G lives in the West with respect to E.

So, the final arrangement is such as-

Floors/Flats	Flat-1	Flat-2	Flat-3
4	R	D	F
3	A	S	B
2	T	V	Q
1	G	E	C

**S15. Ans.(c)**

**Sol.** From the given statements, V lives in the East direction with respect to T. One floor gap between V and D, who lives above V's floor in the same flat and also lives on an even number flat. T lives in an odd number flat. Here we get 2 possibilities i.e. Case 1 and Case 2. A lives just above T in same number flat.

	Case 1			Case 2		
Floors/Flats	Flat-1	Flat-2	Flat-3	Flat-1	Flat-2	Flat-3
4		D				
3	A				D	
2	T	V		A		
1				T	V	

From the given statements, Both S and B are living on the same floor with A. Here we get 2 more possibilities i.e. Case 1a and Case 2a. R lives just above the floor in which A lives and in the west of F.

	Case 1			Case 2		
Floors/Flats	Flat-1	Flat-2	Flat-3	Flat-1	Flat-2	Flat-3
4	R	D	F			
3	A	S	B	R	D	F
2	T	V		A	S	B
1				T	V	

	Case 1a			Case 2a		
Floors/Flats	Flat-1	Flat-2	Flat-3	Flat-1	Flat-2	Flat-3
4	R	D	F			
3	A	B	S	R	D	F
2	T	V		A	B	S
1				T	V	

From the given statements, Q lives just above the floor in which C lives. From this condition Case 2 and Case 2a are ruled out. Both S and C are not live in the same flat. Here Case 1a is ruled out now. G lives in the West with respect to E.

So, the final arrangement is such as-

Floors/Flats	Flat-1	Flat-2	Flat-3
4	R	D	F
3	A	S	B
2	T	V	Q
1	G	E	C

**S16. Ans.(e)**

**Sol.** From the given statements, only three persons were born after the one who is 64 kg. One person was born between K and the one who is 64 kg. **Here we get 2 possibilities i.e. Case 1 and Case 2.** No one born between K and G. The number of persons was born before G is the same as the number of persons born after the one who is 40kg. **Here we get 1 more possibility i.e. Case 1a.**

Months	Date	Case 1		Case 2	
		Persons	Weights(in kg)	Persons	Weights(in kg)
March	11		40		
	24				
April	11				
	24				
June	11			K	40
	24			G	
August	11		64		64
	24				
September	11	K			
	24	G			

Months	Date	Case 1a	
		Persons	Weights(in kg)
March	11		
	24		
April	11		40
	24		
June	11		
	24		
August	11		64
	24	G	
September	11	K	
	24		



From the given statements, C was born just before the one who 55kg in the same month. E was born just before the one who 62 kg and just after the one who 55kg. There were two persons born between the ones who are 62 kg and 64 kg. **Here we get one more possibility i.e. Case 2a.**

Months	Date	Case 1		Case 2	
		Persons	Weights(in kg)	Persons	Weights(in kg)
March	11	C	40	C	
	24		55		55
April	11	E		E	
	24		62		62
June	11			K	40
	24			G	
August	11		64		64
	24				
September	11	K			
	24	G			

Months	Date	Case 1a		Case 2a	
		Persons	Weights(in kg)	Persons	Weights(in kg)
March	11	C			
	24		55		
April	11	E	40		
	24		62		
June	11			K	40
	24			G	
August	11		64	C	64
	24	G			55
September	11	K		E	
	24				62

From the given statements, four persons were born between E and M, who is 45kg. **From this condition Case 1a is ruled out now.** D was born just before H, who is 3<sup>rd</sup> heaviest among all and both were born in the same month. There was one person born between D and B, who was born before D. **From this condition Case 1 and Case 2a are ruled out.** Total weight of G and D is 133kg and G is heavier than D. A is heavier than L. C is not the 2<sup>nd</sup> heaviest among all.

Months	Date	Persons	Weights(in kg)
March	11	C	58
	24	L	55
April	11	E	72
	24	A	62
June	11	K	40
	24	G	76
August	11	B	64
	24	M	45
September	11	D	57
	24	H	70

**S17. Ans.(b)**

**Sol.** From the given statements, only three persons were born after the one who is 64 kg. One person was born between K and the one who is 64 kg. **Here we get 2 possibilities i.e. Case 1 and Case 2.** No one born between K and G. The number of persons was born before G is the same as the number of persons born after the one who is 40kg. **Here we get 1 more possibility i.e. Case 1a.**

Months	Date	Case 1		Case 2	
		Persons	Weights(in kg)	Persons	Weights(in kg)
March	11		40		
	24				
April	11				
	24				
June	11			K	40
	24			G	
August	11		64		64
	24				
September	11	K			
	24	G			



		Case 1a	
Months	Date	Persons	Weights(in kg)
March	11		
	24		
April	11		40
	24		
June	11		
	24		
August	11		64
	24	G	
September	11	K	
	24		

From the given statements, C was born just before the one who 55kg in the same month. E was born just before the one who 62 kg and just after the one who 55kg. There were two persons born between the ones who are 62 kg and 64 kg. **Here we get one more possibility i.e. Case 2a.**

		Case 1		Case 2	
Months	Date	Persons	Weights(in kg)	Persons	Weights(in kg)
March	11	C	40	C	
	24		55		55
April	11	E		E	
	24		62		62
June	11			K	40
	24			G	
August	11		64		64
	24				
September	11	K			
	24	G			

		Case 1a		Case 2a	
Months	Date	Persons	Weights(in kg)	Persons	Weights(in kg)
March	11	C			
	24		55		
April	11	E	40		
	24		62		
June	11			K	40
	24			G	
August	11		64	C	64
	24	G			55
September	11	K		E	
	24				62

From the given statements, four persons were born between E and M, who is 45kg. **From this condition Case 1a is ruled out now.** D was born just before H, who is 3<sup>rd</sup> heaviest among all and both were born in the same month. There was one person born between D and B, who was born before D. **From this**

**condition Case 1 and Case 2a are ruled out.** Total weight of G and D is 133kg and G is heavier than D. A is heavier than L. C is not the 2<sup>nd</sup> heaviest among all.

Months	Date	Persons	Weights(in kg)
March	11	C	58
	24	L	55
April	11	E	72
	24	A	62
June	11	K	40
	24	G	76
August	11	B	64
	24	M	45
September	11	D	57
	24	H	70

**S18. Ans.(c)**

**Sol.** From the given statements, only three persons were born after the one who is 64 kg. One person was born between K and the one who is 64 kg. **Here we get 2 possibilities i.e. Case 1 and Case 2.** No one born between K and G. The number of persons was born before G is the same as the number of persons born after the one who is 40kg. **Here we get 1 more possibility i.e. Case 1a.**

Months	Date	Case 1		Case 2	
		Persons	Weights(in kg)	Persons	Weights(in kg)
March	11		40		
	24				
April	11				
	24				
June	11			K	40
	24			G	
August	11		64		64
	24				
September	11	K			
	24	G			

Months	Date	Case 1a	
		Persons	Weights(in kg)
March	11		
	24		
April	11		40
	24		
June	11		
	24		
August	11		64
	24	G	
September	11	K	
	24		

From the given statements, C was born just before the one who 55kg in the same month. E was born just before the one who 62 kg and just after the one who 55kg. There were two persons born between the ones who are 62 kg and 64 kg. **Here we get one more possibility i.e. Case 2a.**

Months	Date	Case 1		Case 2	
		Persons	Weights(in kg)	Persons	Weights(in kg)
March	11	C	40	C	
	24		55		55
April	11	E		E	
	24		62		62
June	11			K	40
	24			G	
August	11		64		64
	24				
September	11	K			
	24	G			

Months	Date	Case 1a		Case 2a	
		Persons	Weights(in kg)	Persons	Weights(in kg)
March	11	C			
	24		55		
April	11	E	40		
	24		62		
June	11			K	40
	24			G	
August	11		64	C	64
	24	G			55
September	11	K		E	
	24				62

From the given statements, four persons were born between E and M, who is 45kg. **From this condition Case 1a is ruled out now.** D was born just before H, who is 3<sup>rd</sup> heaviest among all and both were born in the same month. There was one person born between D and B, who was born before D. **From this condition Case 1 and Case 2a are ruled out.** Total weight of G and D is 133kg and G is heavier than D. A is heavier than L. C is not the 2<sup>nd</sup> heaviest among all.

Months	Date	Persons	Weights(in kg)
March	11	C	58
	24	L	55
April	11	E	72
	24	A	62
June	11	K	40
	24	G	76
August	11	B	64
	24	M	45
September	11	D	57
	24	H	70

TEST SERIES

**Bilingual**



## FCI 2019

### Manager Phase-I

**30 TOTAL TESTS**

Validity : 12 Months

**S19. Ans.(e)**

**Sol.** From the given statements, only three persons were born after the one who is 64 kg. One person was born between K and the one who is 64 kg. **Here we get 2 possibilities i.e. Case 1 and Case 2.** No one born between K and G. The number of persons was born before G is the same as the number of persons born after the one who is 40kg. **Here we get 1 more possibility i.e. Case 1a.**

Months	Date	Case 1		Case 2	
		Persons	Weights(in kg)	Persons	Weights(in kg)
March	11		40		
	24				
April	11				
	24				
June	11			K	40
	24			G	
August	11		64		64
	24				
September	11	K			
	24	G			

Months	Date	Case 1a	
		Persons	Weights(in kg)
March	11		
	24		
April	11		40
	24		
June	11		
	24		
August	11		64
	24	G	
September	11	K	
	24		



From the given statements, C was born just before the one who 55kg in the same month. E was born just before the one who 62 kg and just after the one who 55kg. There were two persons born between the ones who are 62 kg and 64 kg. **Here we get one more possibility i.e. Case 2a.**

Months	Date	Case 1		Case 2	
		Persons	Weights(in kg)	Persons	Weights(in kg)
March	11	C	40	C	
	24		55		55
April	11	E		E	
	24		62		62
June	11			K	40
	24			G	
August	11		64		64
	24				
September	11	K			
	24	G			

Months	Date	Case 1a		Case 2a	
		Persons	Weights(in kg)	Persons	Weights(in kg)
March	11	C			
	24		55		
April	11	E	40		
	24		62		
June	11			K	40
	24			G	
August	11		64	C	64
	24	G			55
September	11	K		E	
	24				62

From the given statements, four persons were born between E and M, who is 45kg. **From this condition Case 1a is ruled out now.** D was born just before H, who is 3<sup>rd</sup> heaviest among all and both were born in the same month. There was one person born between D and B, who was born before D. **From this condition Case 1 and Case 2a are ruled out.** Total weight of G and D is 133kg and G is heavier than D. A is heavier than L. C is not the 2<sup>nd</sup> heaviest among all.

Months	Date	Persons	Weights(in kg)
March	11	C	58
	24	L	55
April	11	E	72
	24	A	62
June	11	K	40
	24	G	76
August	11	B	64
	24	M	45
September	11	D	57
	24	H	70

**S20. Ans.(a)**

**Sol.** From the given statements, only three persons were born after the one who is 64 kg. One person was born between K and the one who is 64 kg. **Here we get 2 possibilities i.e. Case 1 and Case 2.** No one born between K and G. The number of persons was born before G is the same as the number of persons born after the one who is 40kg. **Here we get 1 more possibility i.e. Case 1a.**

Months	Date	Case 1		Case 2	
		Persons	Weights(in kg)	Persons	Weights(in kg)
March	11		40		
	24				
April	11				
	24				
June	11			K	40
	24			G	
August	11		64		64
	24				
September	11	K			
	24	G			

Months	Date	Case 1a	
		Persons	Weights(in kg)
March	11		
	24		
April	11		40
	24		
June	11		
	24		
August	11		64
	24	G	
September	11	K	
	24		

From the given statements, C was born just before the one who 55kg in the same month. E was born just before the one who 62 kg and just after the one who 55kg. There were two persons born between the ones who are 62 kg and 64 kg. **Here we get one more possibility i.e. Case 2a.**

Months	Date	Case 1		Case 2	
		Persons	Weights(in kg)	Persons	Weights(in kg)
March	11	C	40	C	
	24		55		55
April	11	E		E	
	24		62		62
June	11			K	40
	24			G	
August	11		64		64
	24				
September	11	K			
	24	G			

Months	Date	Case 1a		Case 2a	
		Persons	Weights(in kg)	Persons	Weights(in kg)
March	11	C			
	24		55		
April	11	E	40		
	24		62		
June	11			K	40
	24			G	
August	11		64	C	64
	24	G			55
September	11	K		E	
	24				62

From the given statements, four persons were born between E and M, who is 45kg. **From this condition Case 1a is ruled out now.** D was born just before H, who is 3<sup>rd</sup> heaviest among all and both were born in the same month. There was one person born between D and B, who was born before D. **From this condition Case 1 and Case 2a are ruled out.** Total weight of G and D is 133kg and G is heavier than D. A is heavier than L. C is not the 2<sup>nd</sup> heaviest among all.

Months	Date	Persons	Weights(in kg)
March	11	C	58
	24	L	55
April	11	E	72
	24	A	62
June	11	K	40
	24	G	76
August	11	B	64
	24	M	45
September	11	D	57
	24	H	70

**S21. Ans.(c)**

**Sol.** In the above question we have to find which statement negates the given statement.

For I-This statement supports the given statement as it describes about the revolution that technology has bring in India which is a mark of achievement of Modi’s government.

For II-This statement also supports the given statement as it describes the country’s growth in Modi government’s tenure which is considered as victory of his government.

For III-This negates of the given statement as it defines the problems of poverty and corruption that India is still facing which can be considered as flaw of Modi’s government.

For IV-It supports the given statement as number of FDI’s has increased in India in current scenario as given in the statement.

**S22. Ans.(b)**

**Sol.** In the statement we have to pick the statement which can be assumed from above statement.

For Statement I. Wrong, because it was not possible to destroy the existing stocks by the end of this month that is why the companies pleaded to the Supreme Court.

For Statement II. Right, because it is clear from the above statement that the court had fixed the deadline 31 may earlier and there after extended it to 31 july.

For Statement III. Right, because to dispose-off stock and transporting it out of the state requires clearance.

TEST SERIES

Bilingual

VIDEO SOLUTIONS



IBPS CLERK 2019

PRELIMS

35 TOTAL TESTS

Validity : 12 Months

**S23. Ans.(e)**

**Sol.** In the above question we have to find which statement concludes the given statement.

For I- This statement states about compulsion of Adahaar with PAN to avoid fraud in taxation system whereas the given statement states about mandating Aadhaar in banking transactions. So this cannot be concluded from the given statement.

For II- It cannot be concluded as it is not given in the statement whether Adhaar is more secure or not.

For III-It is not related to the statement as it is general information.

**S24. Ans.(b)**

**Sol.** From the given statements, Sonu sits 2<sup>nd</sup> to the right of Atul, who likes Cherry. **Here we get 2 possibilities i.e. Case 1 and Case 2.** Both Sourav and Sonu are immediate neighbors to each other. **Here we get 2 more possibilities i.e. Case 1a and Case 2a.** The one who likes Plum sits opposite to Sourav. Dev faces outside from the table and not sit near to Atul. Kamal sits 2<sup>nd</sup> to the left of Dev, who does not like Plum.

**Case 1**

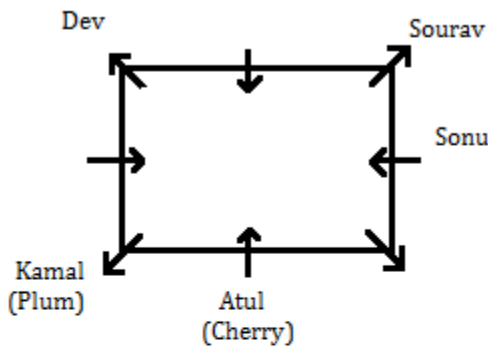

**Case 2**

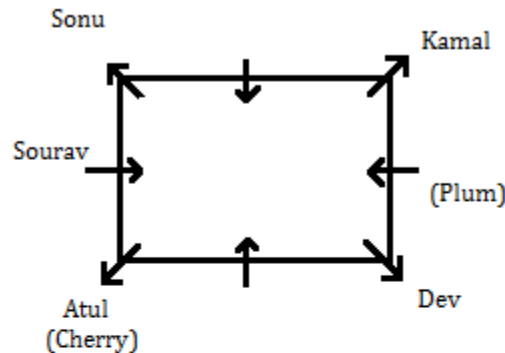

**Case 1a**

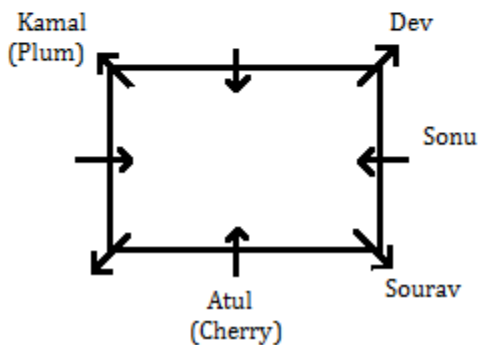

**Case 2a**

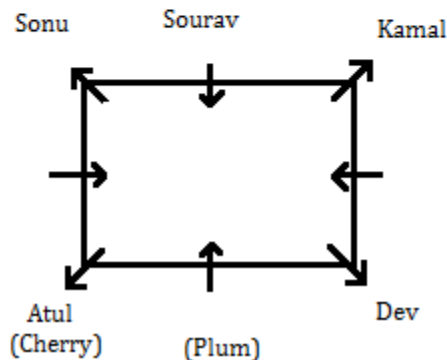

From the given statements, Arun likes Grape and sits 2<sup>nd</sup> to the right of Rohit. Rohit likes Banana. **From this condition Case 2 and Case 2a are ruled out.** The persons who like Mango and Orange sit opposite to each other. The persons who like Orange and Apple are immediate neighbors. The one who likes Pear sits near to the one who likes Banana. **From this condition Case 1a is ruled out now.**

**So, the final arrangement is such as-**



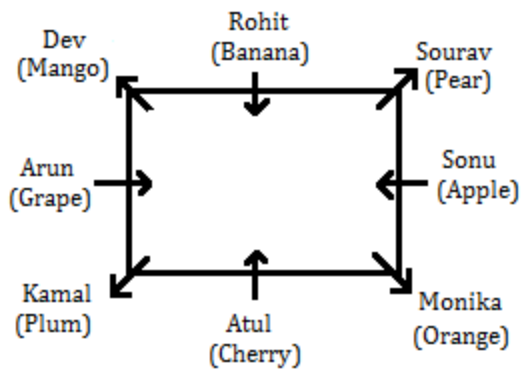

**S25. Ans.(e)**

**Sol.** From the given statements, Sonu sits 2<sup>nd</sup> to the right of Atul, who likes Cherry. **Here we get 2 possibilities i.e. Case 1 and Case 2.** Both Sourav and Sonu are immediate neighbors to each other. **Here we get 2 more possibilities i.e. Case 1a and Case 2a.** The one who likes Plum sits opposite to Sourav. Dev faces outside from the table and not sit near to Atul. Kamal sits 2<sup>nd</sup> to the left of Dev, who does not like Plum.

**Case 1**

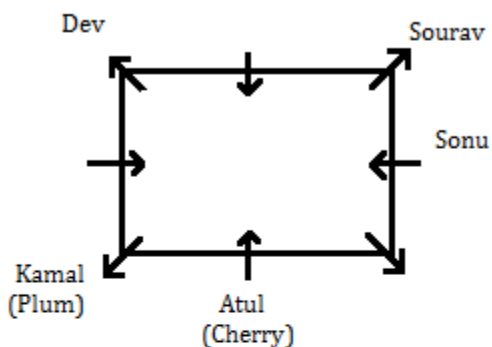

**Case 2**

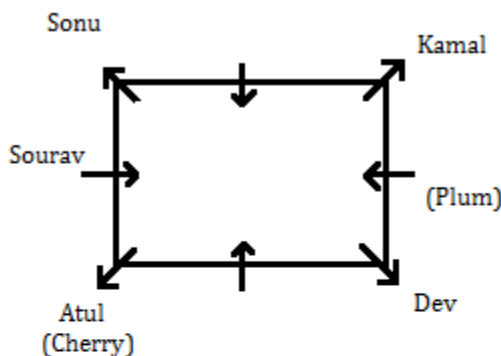

**Case 1a**

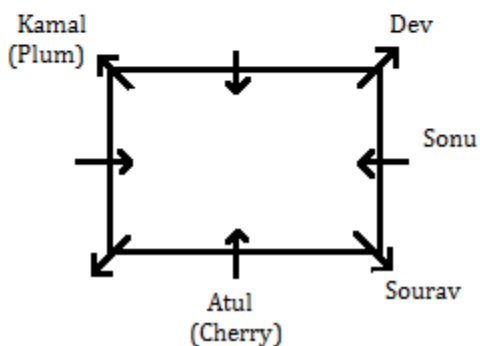

**Case 2a**

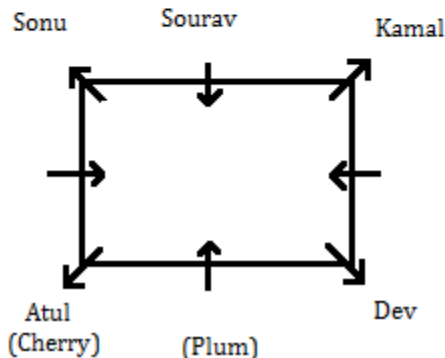

From the given statements, Arun likes Grape and sits 2<sup>nd</sup> to the right of Rohit. Rohit likes Banana. **From this condition Case 2 and Case 2a are ruled out.** The persons who like Mango and Orange sit opposite to each other. The persons who like Orange and Apple are immediate neighbors. The one who likes Pear sits near to the one who likes Banana. **From this condition Case 1a is ruled out now.**

So, the final arrangement is such as-

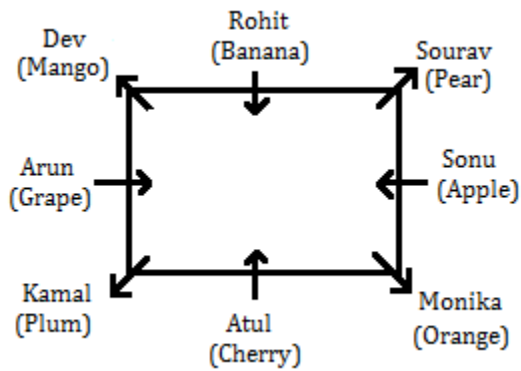

S26. Ans.(d)

Sol. From the given statements, Sonu sits 2<sup>nd</sup> to the right of Atul, who likes Cherry. **Here we get 2 possibilities i.e. Case 1 and Case 2.** Both Sourav and Sonu are immediate neighbors to each other. **Here we get 2 more possibilities i.e. Case 1a and Case 2a.** The one who likes Plum sits opposite to Sourav. Dev faces outside from the table and not sit near to Atul. Kamal sits 2<sup>nd</sup> to the left of Dev, who does not like Plum.

Case 1

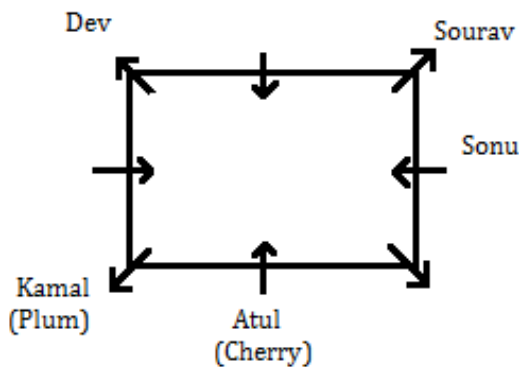

Case 2

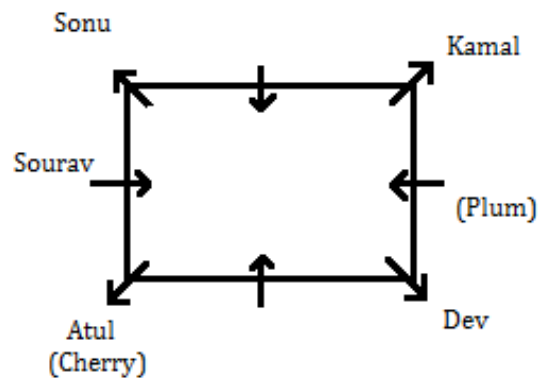

Case 1a

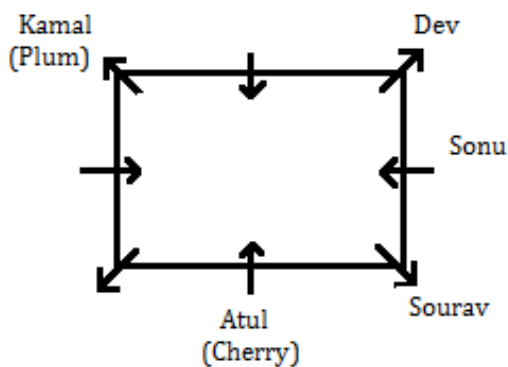

Case 2a

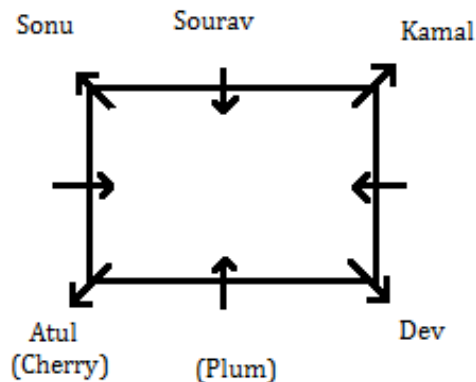

From the given statements, Arun likes Grape and sits 2<sup>nd</sup> to the right of Rohit. Rohit likes Banana. **From this condition Case 2 and Case 2a are ruled out.** The persons who like Mango and Orange sit opposite to each other. The persons who like Orange and Apple are immediate neighbors. The one who likes Pear sits near to the one who likes Banana. **From this condition Case 1a is ruled out now.**

So, the final arrangement is such as-

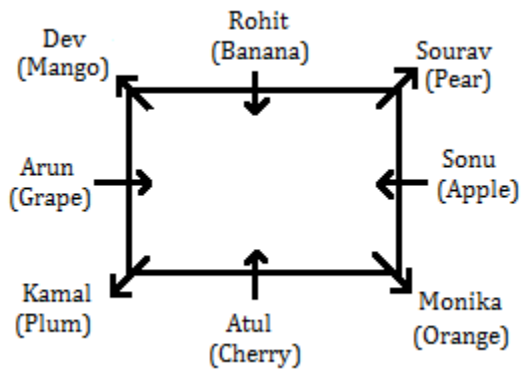

**Special Offer**

**IBPS RRB PO  
MAINS 2019**

**35 MOCK PAPERS**

**Validity : 1 Month**

S27. Ans.(a)

**Sol.** From the given statements, Sonu sits 2<sup>nd</sup> to the right of Atul, who likes Cherry. **Here we get 2 possibilities i.e. Case 1 and Case 2.** Both Sourav and Sonu are immediate neighbors to each other. **Here we get 2 more possibilities i.e. Case 1a and Case 2a.** The one who likes Plum sits opposite to Sourav. Dev faces outside from the table and not sit near to Atul. Kamal sits 2<sup>nd</sup> to the left of Dev, who does not like Plum.

**Case 1**

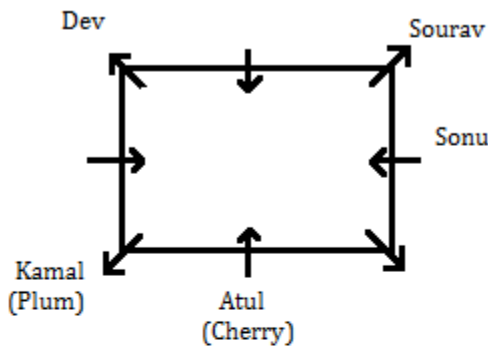

**Case 2**

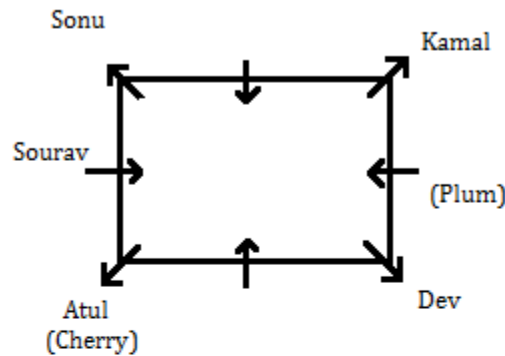

**Case 1a**

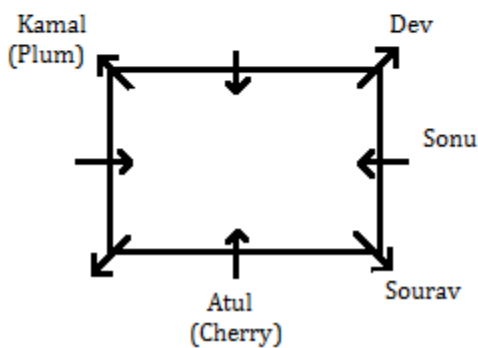

**Case 2a**

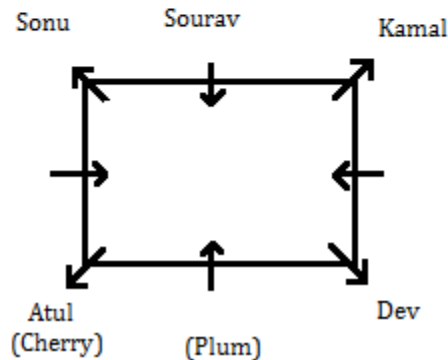

From the given statements, Arun likes Grape and sits 2<sup>nd</sup> to the right of Rohit. Rohit likes Banana. **From this condition Case 2 and Case 2a are ruled out.** The persons who like Mango and Orange sit opposite to each other. The persons who like Orange and Apple are immediate neighbors. The one who likes Pear sits near to the one who likes Banana. **From this condition Case 1a is ruled out now.**

So, the final arrangement is such as-

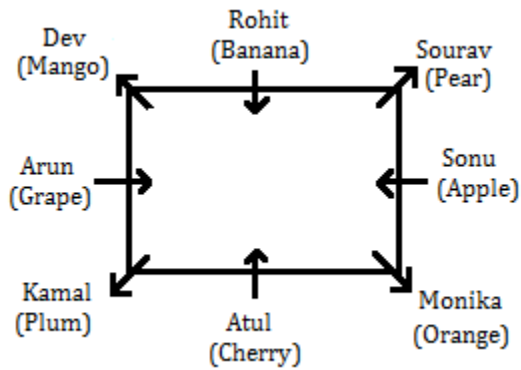

S28. Ans.(c)

Sol. From the given statements, Sonu sits 2<sup>nd</sup> to the right of Atul, who likes Cherry. **Here we get 2 possibilities i.e. Case 1 and Case 2.** Both Sourav and Sonu are immediate neighbors to each other. **Here we get 2 more possibilities i.e. Case 1a and Case 2a.** The one who likes Plum sits opposite to Sourav. Dev faces outside from the table and not sit near to Atul. Kamal sits 2<sup>nd</sup> to the left of Dev, who does not like Plum.

Case 1

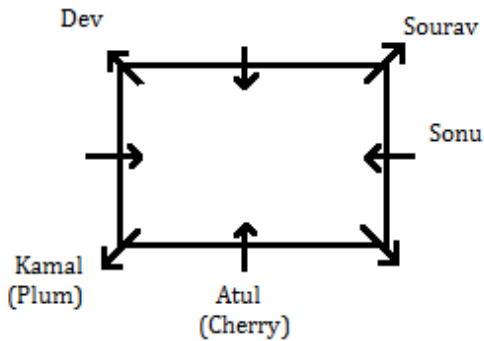

Case 2

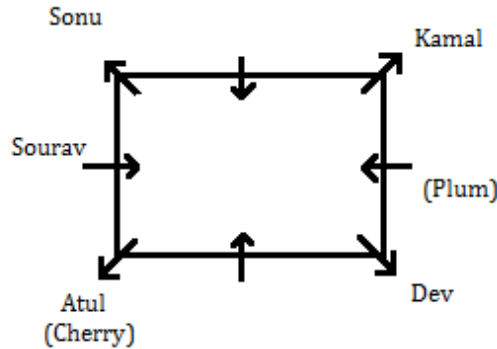

Case 1a

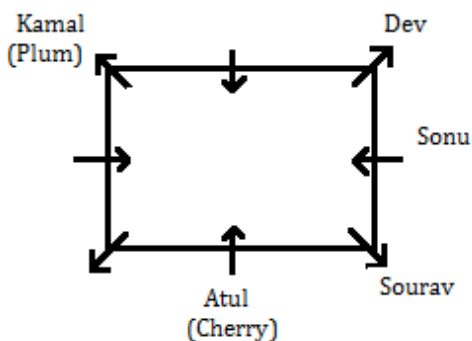

Case 2a

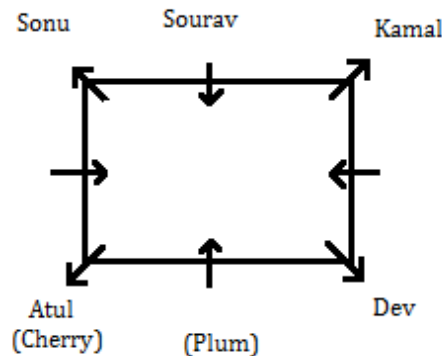

From the given statements, Arun likes Grape and sits 2<sup>nd</sup> to the right of Rohit. Rohit likes Banana. **From this condition Case 2 and Case 2a are ruled out.** The persons who like Mango and Orange sit opposite to each other. The persons who like Orange and Apple are immediate neighbors. The one who likes Pear sits near to the one who likes Banana. **From this condition Case 1a is ruled out now.**

So, the final arrangement is such as-

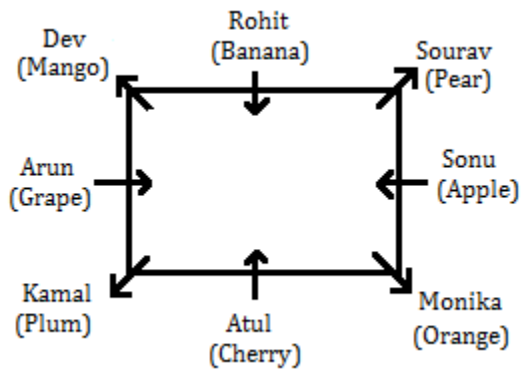

S29. Ans.(b)

Sol.

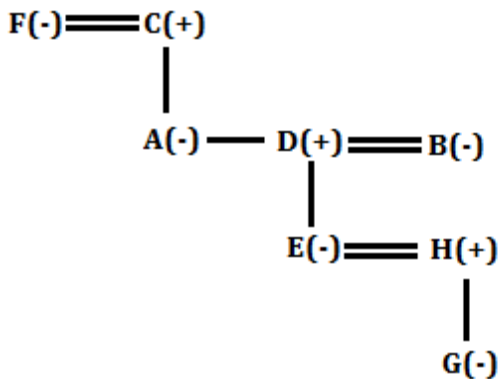

S30. Ans.(c)

Sol.

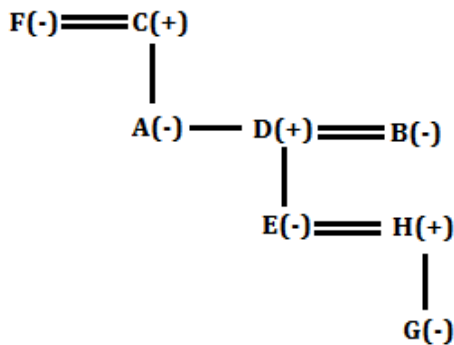

S31. Ans.(b)

Sol. From the given statements, only two persons are taller than A, who sits 2<sup>nd</sup> to the left of the one who likes Bagel. Only two persons sit between C, who likes Burger and the one who likes Bagel. Here we get 2 possibilities i.e. Case 1 and Case 2. F sits immediate left of C and just smaller than C.

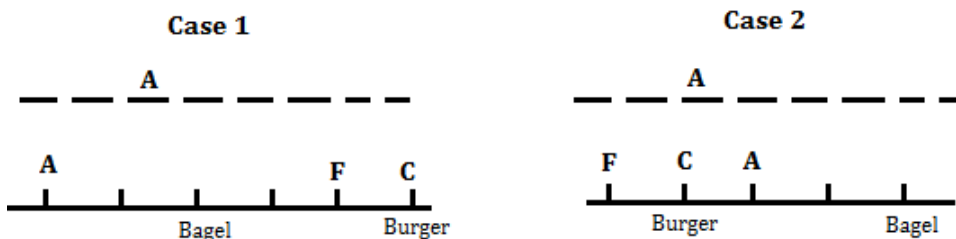

From the given statements, F is just smaller than C. D is just taller than C and just smaller than E. Three persons sit between F and the one who is just taller than C. (D is just taller than C which means three persons sit between F and D). Here Case 1 is ruled out now. F is not the shortest among all. Only one person sits between D and the one who likes Pizza. Here we get one more possibility i.e. Case 2a.

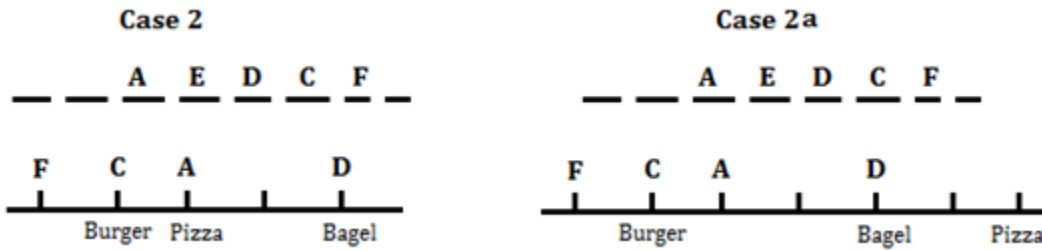

From the given statements, two persons sit between E and the one who is 2<sup>nd</sup> shortest among all. Here one more possibility added i.e. Case 2b. G is just smaller than the one who is 5ft tall. H is 7ft tall but not the tallest among all. The one who is tallest among all is an immediate neighbor of both F and H. From this condition Case 2a is ruled out now.

$$B > H > A > E > D > C > F > G$$

7ft                      5ft

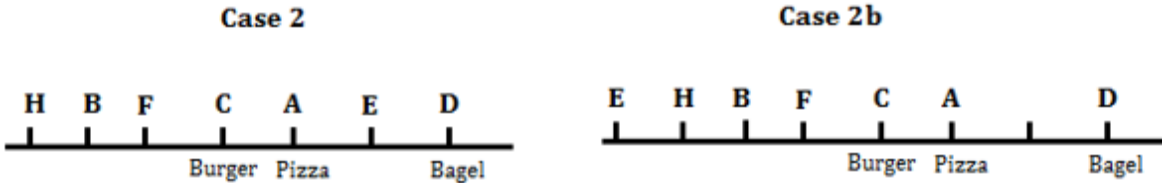

From the given statements, Both G and D, are immediate neighbors. There are two persons sit between the ones who like Pizza and Bread, who does not sit at the extreme end of the row. F neither like Cheese nor Pizza. H does not like Cheese. The number of persons sits to the left of the one who likes Cheese is same as the number of persons sits to the right of the one who likes Pasta. The one who likes Pie sits right side of the one who likes Rice. C is an immediate neighbor of the one who likes Rice. **From this condition Case 2b is ruled out now.**

So, the final arrangement is such as-

$$B > H > A > E > D > C > F > G$$

7ft                      5ft

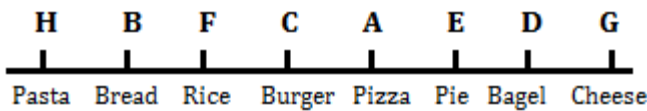

**S32. Ans.(a)**

**Sol.** From the given statements, only two persons are taller than A, who sits 2<sup>nd</sup> to the left of the one who likes Bagel. Only two persons sit between C, who likes Burger and the one who likes Bagel. Here we get 2 possibilities i.e. Case 1 and Case 2. F sits immediate left of C and just smaller than C.

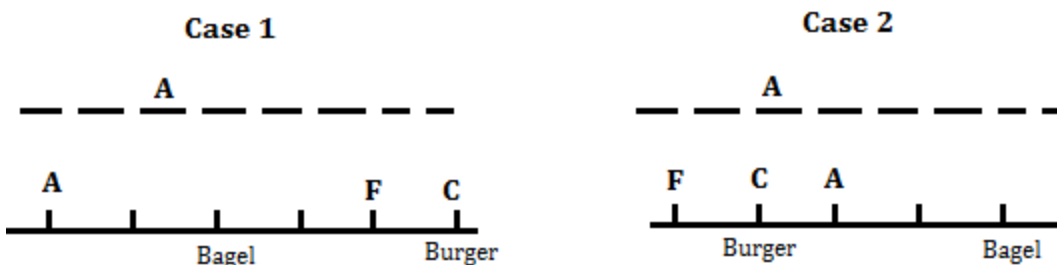

From the given statements, F is just smaller than C. D is just taller than C and just smaller than E. Three persons sit between F and the one who is just taller than C. (D is just taller than C which means three persons sit between F and D). Here Case 1 is ruled out now. F is not the shortest among all. Only one person sits between D and the one who likes Pizza. Here we get one more possibility i.e. Case 2a.

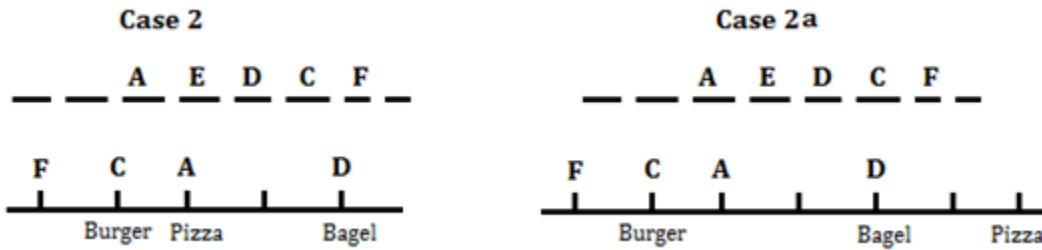

From the given statements, two persons sit between E and the one who is 2<sup>nd</sup> shortest among all. Here one more possibility added i.e. Case 2b. G is just smaller than the one who is 5ft tall. H is 7ft tall but not the tallest among all. The one who is tallest among all is an immediate neighbor of both F and H. From this condition Case 2a is ruled out now.

$$B > H > A > E > D > C > F > G$$

7ft                      5ft

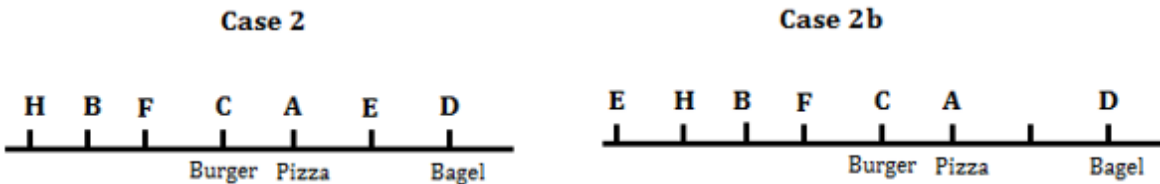

From the given statements, Both G and D, are immediate neighbors. There are two persons sit between the ones who like Pizza and Bread, who does not sit at the extreme end of the row. F neither like Cheese nor Pizza. H does not like Cheese. The number of persons sits to the left of the one who likes Cheese is same as the number of persons sits to the right of the one who likes Pasta. The one who likes Pie sits right side of the one who likes Rice. C is an immediate neighbor of the one who likes Rice. **From this condition Case 2b is ruled out now.**

So, the final arrangement is such as-

$$B > H > A > E > D > C > F > G$$

7ft                      5ft

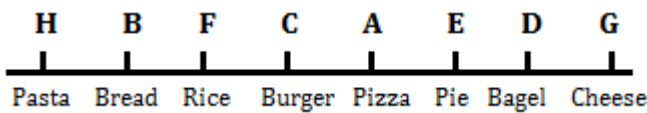

**S33. Ans.(a)**

**Sol.** From the given statements, only two persons are taller than A, who sits 2<sup>nd</sup> to the left of the one who likes Bagel. Only two persons sit between C, who likes Burger and the one who likes Bagel. Here we get 2 possibilities i.e. Case 1 and Case 2. F sits immediate left of C and just smaller than C.

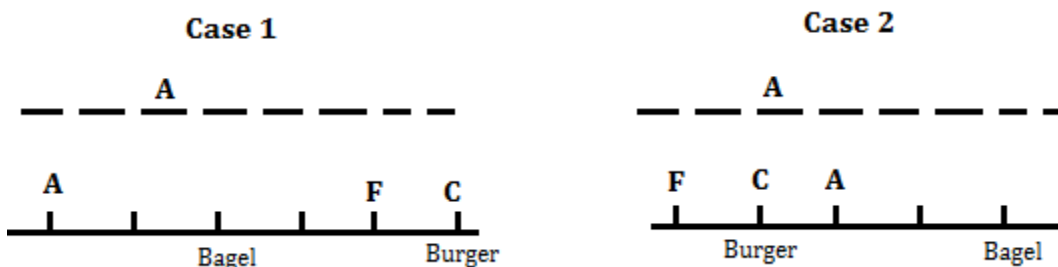

From the given statements, F is just smaller than C. D is just taller than C and just smaller than E. Three persons sit between F and the one who is just taller than C. (D is just taller than C which means three persons sit between F and D). Here Case 1 is ruled out now. F is not the shortest among all. Only one person sits between D and the one who likes Pizza. Here we get one more possibility i.e. Case 2a.

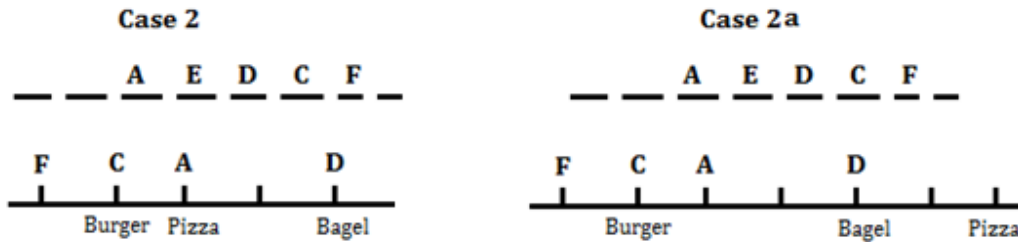

From the given statements, two persons sit between E and the one who is 2<sup>nd</sup> shortest among all. Here one more possibility added i.e. Case 2b. G is just smaller than the one who is 5ft tall. H is 7ft tall but not the tallest among all. The one who is tallest among all is an immediate neighbor of both F and H. From this condition Case 2a is ruled out now.

$$B > H > A > E > D > C > F > G$$

7ft                      5ft

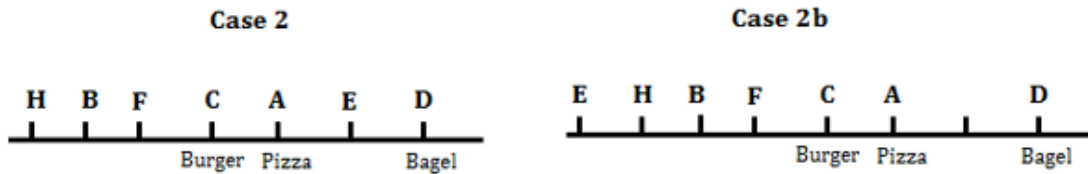

From the given statements, Both G and D, are immediate neighbors. There are two persons sit between the ones who like Pizza and Bread, who does not sit at the extreme end of the row. F neither like Cheese nor Pizza. H does not like Cheese. The number of persons sits to the left of the one who likes Cheese is same as the number of persons sits to the right of the one who likes Pasta. The one who likes Pie sits right side of the one who likes Rice. C is an immediate neighbor of the one who likes Rice. **From this condition Case 2b is ruled out now.**

So, the final arrangement is such as-

$$B > H > A > E > D > C > F > G$$

7ft                      5ft

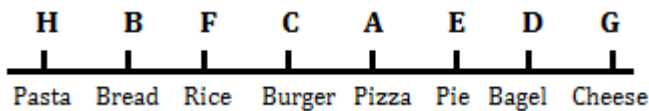

**S34. Ans.(e)**

**Sol.** From the given statements, only two persons are taller than A, who sits 2<sup>nd</sup> to the left of the one who likes Bagel. Only two persons sit between C, who likes Burger and the one who likes Bagel. Here we get 2 possibilities i.e. Case 1 and Case 2. F sits immediate left of C and just smaller than C.

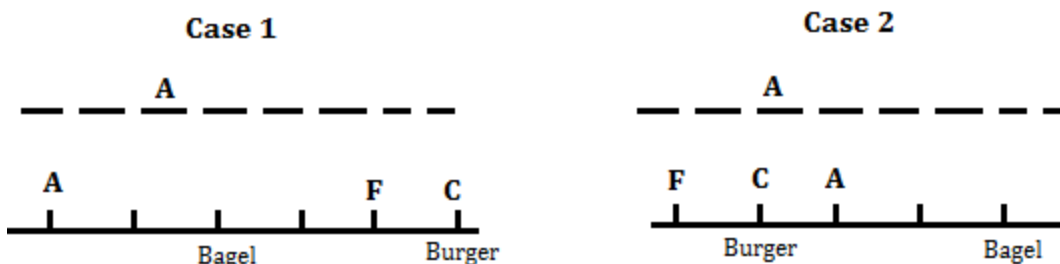



From the given statements, F is just smaller than C. D is just taller than C and just smaller than E. Three persons sit between F and the one who is just taller than C. (D is just taller than C which means three persons sit between F and D). Here Case 1 is ruled out now. F is not the shortest among all. Only one person sits between D and the one who likes Pizza. Here we get one more possibility i.e. Case 2a.

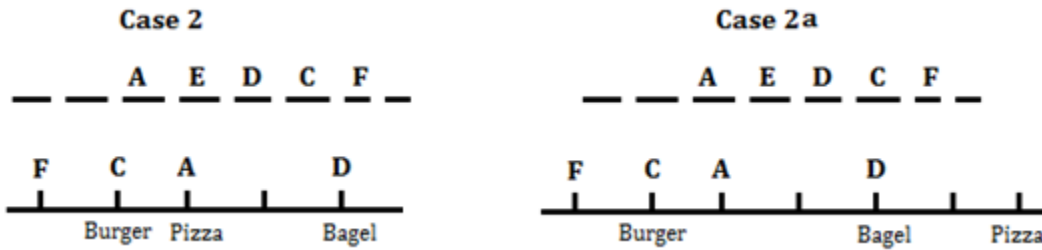

From the given statements, two persons sit between E and the one who is 2<sup>nd</sup> shortest among all. Here one more possibility added i.e. Case 2b. G is just smaller than the one who is 5ft tall. H is 7ft tall but not the tallest among all. The one who is tallest among all is an immediate neighbor of both F and H. From this condition Case 2a is ruled out now.

$$B > H > A > E > D > C > F > G$$

7ft                      5ft

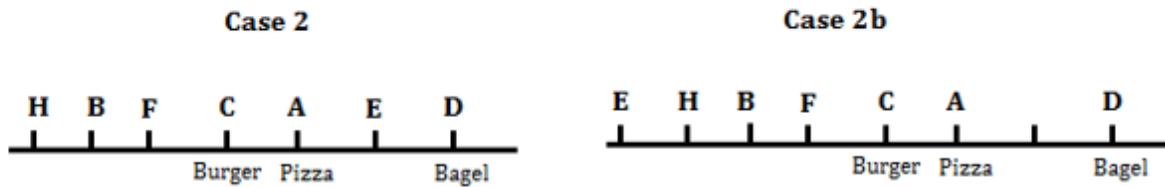

From the given statements, Both G and D, are immediate neighbors. There are two persons sit between the ones who like Pizza and Bread, who does not sit at the extreme end of the row. F neither like Cheese nor Pizza. H does not like Cheese. The number of persons sits to the left of the one who likes Cheese is same as the number of persons sits to the right of the one who likes Pasta. The one who likes Pie sits right side of the one who likes Rice. C is an immediate neighbor of the one who likes Rice. **From this condition Case 2b is ruled out now.**

So, the final arrangement is such as-

$$B > H > A > E > D > C > F > G$$

7ft                      5ft

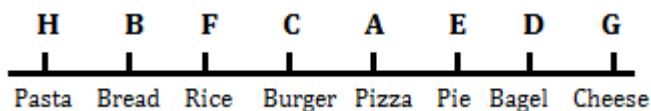

**S35. Ans.(c)**

**Sol.** From the given statements, only two persons are taller than A, who sits 2<sup>nd</sup> to the left of the one who likes Bagel. Only two persons sit between C, who likes Burger and the one who likes Bagel. Here we get 2 possibilities i.e. Case 1 and Case 2. F sits immediate left of C and just smaller than C.

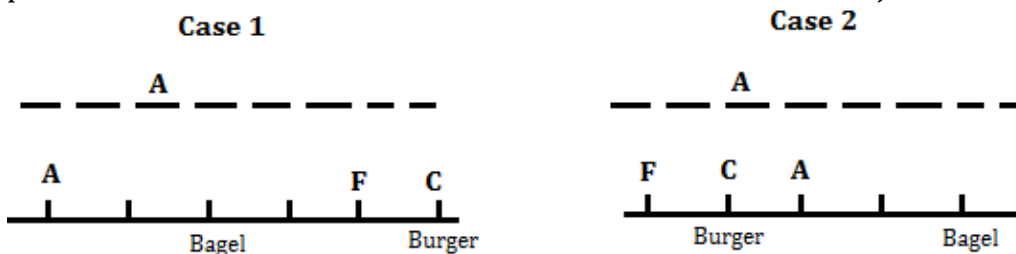

From the given statements, F is just smaller than C. D is just taller than C and just smaller than E. Three persons sit between F and the one who is just taller than C. (D is just taller than C which means three persons sit between F and D). Here Case 1 is ruled out now. F is not the shortest among all. Only one person sits between D and the one who likes Pizza. Here we get one more possibility i.e. Case 2a.

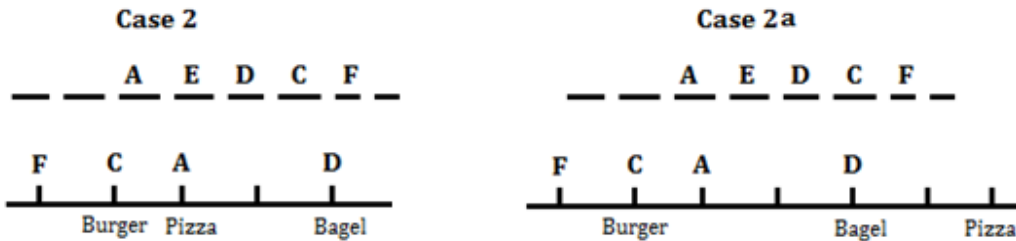

From the given statements, two persons sit between E and the one who is 2<sup>nd</sup> shortest among all. Here one more possibility added i.e. Case 2b. G is just smaller than the one who is 5ft tall. H is 7ft tall but not the tallest among all. The one who is tallest among all is an immediate neighbor of both F and H. From this condition Case 2a is ruled out now.

$$B > H > A > E > D > C > F > G$$

7ft                      5ft

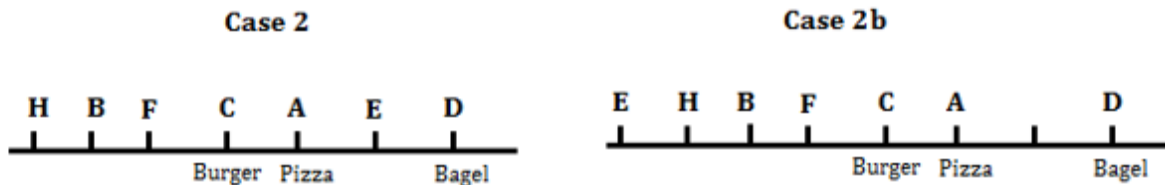

From the given statements, Both G and D, are immediate neighbors. There are two persons sit between the ones who like Pizza and Bread, who does not sit at the extreme end of the row. F neither like Cheese nor Pizza. H does not like Cheese. The number of persons sits to the left of the one who likes Cheese is same as the number of persons sits to the right of the one who likes Pasta. The one who likes Pie sits right side of the one who likes Rice. C is an immediate neighbor of the one who likes Rice. **From this condition Case 2b is ruled out now.**

So, the final arrangement is such as-

$$B > H > A > E > D > C > F > G$$

7ft                      5ft

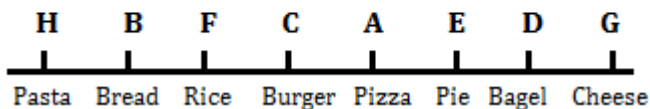

**S36. Ans.(b)**

**Sol.** Even number is followed by an odd prime number so = 8+3= 11

Then 1 row - 11 6

Odd number is followed by an even number (but not perfect square) so = 11\*6=66 (resultant of first row)

In row 2 Odd number is followed by a perfect square so = 16-9 = 7

Then 2 row- 7 7

Odd number is followed by an odd number (but not perfect square) so = 7 + 7 = 14 (resultant of second row)

So, the sum of resultant of both row = 66 + 14 = 80

**S37. Ans.(c)****Sol.** Even number is followed by an prime odd number so =10+ 5 = 15

The row is 15 7

Odd number is followed by an odd number(but not perfect square) so =15 +7 = 22(resultant of first row)

The sum of the rows is 46 so the resultant of second row= 46- 22 = 24

Even number is followed by X and X is followed by 8

When X = 15, then this condition can be satisfied. ( 15-12 = 3 and 3\*8 = 24)

**S38. Ans.(a)****Sol.** Odd number is followed by a perfect square so =16- 13= 3Odd number is followed by an even number(but not perfect square) so = 3 \*18 = 54(resultant of 1<sup>st</sup> row)

Odd number is followed by a perfect square so =9- 7 = 2

Even number is followed by an odd prime number so = 2 +11 =13(resultant of 2<sup>nd</sup> row)

So, the difference is = 54 - 13 = 41

**S39. Ans.(c)****Sol.** Even number is followed by a nonprime odd number so =21-12 = 9,

the row is 9 7

Odd number is followed by an odd prime number so =9 + 7 = 16(resultant of first row)=X

The second row is 5 16 9

Odd number is followed by a perfect square so =16 - 5 = 11

Odd number is followed by a perfect square so = 11 -9 = 2 ( resultant of second row)

**S40. Ans.(b)****Sol.** In the second row, even number is followed by a prime odd number so =18+5=23

Odd number is followed by an odd number(but not perfect square) so =23 +13 = 36(resultant of second row)= X

First row is 36 5 16

Even number is followed by a prime odd number so = 36 + 5 = 41

Odd number is followed by a perfect square so = 41 - 16 = 25(resultant of first row)

So, the sum is 36 + 25 = 61

**S41. Ans.(e)****Sol.**

$$\begin{aligned} \text{Total population of all cities together} \\ &= \frac{180000}{30} \times 100 = 600000 \end{aligned}$$

$$\begin{aligned} \text{Total male population} &= \frac{600000}{3} \times 2 \\ &= 400000 \end{aligned}$$

$$\begin{aligned} \text{Female population of city L} \\ &= \frac{16}{100} \times 600000 - \frac{20}{100} \times 400000 \\ &= 96000 - 80000 \\ &= 16000 \end{aligned}$$

TEST SERIES

Bilingual



# FCI 2019 Manager Phase-I

## 30 TOTAL TESTS

### Validity : 12 Months

**S42. Ans.(b)****Sol.**

Let total population and male population is  $300x$  and  $200x$  respectively.

$\Rightarrow$  Total population of city M and city J is

$$\frac{22 \times 300x}{100} = 66x \text{ and } \frac{12 \times 300x}{100} = 36x$$

$\Rightarrow$  Male population of city M and city J is

$$\frac{18 \times 200x}{100} = 36x \text{ and } \frac{16 \times 200x}{100} = 32x$$

$$\text{Required ratio} = \frac{66x - 36x}{36x - 32x} = \frac{15}{2}$$

$\Rightarrow 15 : 2$

**S43. Ans.(a)****Sol.**

Let total population of all cities is  $300x$

So total male population =  $200x$

Female population of city K.

$$\Rightarrow \frac{30 \times 300x}{100} - \frac{32 \times 200x}{100} = 26x$$

Male population of city M =  $36x$

$$\text{Required percentage} = \frac{26x}{36x} \times 100 = \frac{650}{9}\%$$

$$= 72\frac{2}{9}\%$$

**S44. Ans.(d)****Sol.** Required average

$$= \frac{1}{3} \left[ \frac{(20 + 12 + 30) \times 600000}{100} - \frac{(14 + 16 + 32) \times 400000}{100} \right]$$

$$= \frac{124000}{3}$$

**S45. Ans.(c)****Sol.**

Total male population of all cities

$$= \frac{100000}{20} \times 100 = 500000$$

Total population of all cities

$$= \frac{500000}{2} \times 3 = 750000$$

Female population of city M

$$= \frac{22}{100} \times 750000 - \frac{18}{100} \times 500000$$

$$= 75000$$

Male population of city K

$$= \frac{500000}{100} \times 32$$

$$= 160000$$

$$\text{Required}\% = \frac{75000}{160000} \times 100 = 46.875\%$$

Alternate,

Let total population of all cities is  $300x$

So total male population =  $200x$

Female population of city M

$$= \frac{22}{100} \times 300x - \frac{18}{100} \times 200x$$

$$= 66x - 36x = 30x$$

Male population of city K

$$= \frac{32}{100} \times 200x = 64x$$

$$\text{Required\%} = \frac{30x}{64x} \times 100 = 46.875\%$$

#### S46. Ans.(d)

Sol.

Probability of getting tail on 1<sup>st</sup> coin =  $1/5$

Probability of getting tail on 2<sup>nd</sup> coin

$$= \frac{36}{100} = \frac{9}{25}$$

$$\text{Required Probability} = \frac{1}{5} \times \frac{16}{25} + \frac{9}{25} \times \frac{4}{5}$$

$$= \frac{16}{125} + \frac{36}{125} = \frac{52}{125} = 41.6\%$$

#### S47. Ans.(b)

Sol.

Let times by Rahul to cover a distance

'D' in downstream is  $\rightarrow 3x$

So, time taken to cover 'D' distance in upstream  $\rightarrow 7x$

$\Rightarrow$  Speed of Rahul in downstream and upstream be  $7x$  and  $3x$  respectively

$$\text{Speed of stream} \rightarrow \frac{7x-3x}{2} = \frac{4x}{2} = 2x$$

And, speed of Rahul's friend in downstream

$$\rightarrow 7x \times \frac{6}{7} = 6x$$

Speed of Rahul in still water =  $7x - 2x = 5x$

Speed of Rahul's friend in still water =  $6x - 2x = 4x$

Required ratio =  $5 : 4$

#### S48. Ans.(a)

Sol.

Let A's, B's, C's investment be  $x$ ,  $y$  and  $z$  respectively

ATQ,

$$\frac{x \times 12}{y \times 8} = \frac{10,000}{25,000}$$

$$\Rightarrow y = 562500$$

And,

$$\frac{x \times 12}{z \times 9} = \frac{10,000}{20,000}$$

$$\Rightarrow z = 400000$$

Required difference =  $162500$



**S49. Ans.(d)****Sol.**Let no. of officers and clerks are  $4x$  and  $5x$  resp.Let total salary of all clerks is  $\rightarrow y$ Then total salary of all officers is  $\rightarrow 2.4y$ 

ATQ,

$$\rightarrow y + 2.4y = 1020000$$

$$y = 300000$$

$$2.4y = 720000$$

$$\text{Salary of 'x' officers} = \frac{720000}{4} = 180000$$

$$\text{Salary of 'x' clerks} = \frac{300000}{5} = 60,000$$

$$\text{Now Required \%} = \frac{(180000 - 60000)}{60000} \times 100 = 200\%$$

Alternate,

Let no. of officers and clerks are  $4x$  and  $5x$  resp.Let salary of one officer and one clerk be ' $z$ ' and ' $y$ ' respectively

ATQ

$$4x \times z = 2.4 \times 5xy$$

$$\Rightarrow z = 3y$$

$$\text{Required \%} = \frac{z-y}{y} \times 100 = \frac{3y-y}{y} \times 100$$

$$= \frac{2y}{y} \times 100 = 200\%$$

**S50. Ans.(e)****Sol.**

ATQ,

$$42 + 2\% = 36\% - 9$$

$$51 = 34\%$$

$$1\% = \frac{3}{2}$$

$$100\% = 150$$

$$80\% = 120$$

$$\text{Vikas} \rightarrow 120 - 42 = 78$$

$$\text{Sumit} \rightarrow 120 - \frac{36}{100} \times 150 = 66$$

$$\text{Together} \rightarrow 144$$

**S51. Ans.(d)****Sol.**

Average speed of Monu to Cover distance

$$\text{on Monday and Tuesday together} = \frac{\text{Total distance covered}}{\text{Total time taken}}$$

$$= \frac{120+225}{2+3} = \frac{345}{5} = 69 \text{ km/h}$$

Distance travelled by Sonu on Wednesday

$$= \frac{140}{5} \times 7$$

$$= 196 \text{ km}$$

# IBPS RRB Clerk Mains

## Memory Based Practice Set

- Based on RRB PO Mains
- GA + COMPUTER

**Bilingual**

Distance travelled by Sonu on Thursday

$$= \frac{135}{3} \times 4$$

$$= 180 \text{ km}$$

Average speed of Sonu to cover distance on

$$\text{Wednesday and Thursday together} = \frac{\text{Total distance covered}}{\text{Total time taken}}$$

$$= \frac{196 + 180}{8} = \frac{376}{8} = 47 \text{ km/h}$$

$$\text{Required difference} = 69 - 47 = 22$$

**S52. Ans.(c)**

**Sol.**

$$\text{Distance covered by Sonu on Friday} = \frac{210}{6} \times 7 = 245 \text{ km}$$

$$\text{Distance covered by Sonu on Thursday} = \frac{135}{3} \times 4 = 180 \text{ km}$$

$$\text{Speed of Sonu on Friday} = \frac{245}{5} = 49 \text{ km/h}$$

$$\text{Speed of Sonu on Thursday} = \frac{180}{4.5} = 40 \text{ km/h}$$

$$\text{Required \%} = \frac{49-40}{40} \times 100 = \frac{9}{40} \times 100 = 22.5\%$$

**S53. Ans.(b)**

**Sol.**

$$\text{Distance covered by Sonu on Friday} = \frac{210}{6} \times 7$$
$$= 245 \text{ km}$$

$$\text{Speed of Sonu on Friday} = \frac{245}{5} = 49 \text{ km/h}$$

$$\text{Speed of Sonu on Saturday} = \frac{49}{7} \times 10 = 70 \text{ km/h}$$

$$\text{Speed of Monu on Saturday} = \frac{70}{7} \times 6 = 60 \text{ km/h}$$

$$\text{Required time} = \frac{210}{60} + \frac{245}{70} = 3.5 + 3.5 = 7 \text{ hr}$$

**S54. Ans.(a)**

**Sol.**

$$\text{Distance covered by Sonu on Tuesday} = \frac{225}{9} \times 11 = 275 \text{ km}$$

$$\text{Speed of Sonu on Tuesday} = \frac{275}{25} = 110 \text{ km/h}$$

$$\text{If speed of Sonu increases by 25\% on Tuesday} = 110 \times 1.25$$
$$= 137.5 \text{ km/h}$$

$$\text{Time taken to cover distance} = \frac{275}{137.5} = 2$$

$$\text{Required difference} = 2.5 - 2 = 0.5 \text{ hour}$$
$$= 30 \text{ minutes}$$



**S55. Ans.(e)****Sol.**

$$\text{Speed of Monu on Thursday} = \frac{135}{2.5} = 54 \text{ km/h}$$

$$\text{Distance covered by Sonu on Monday} = \frac{120}{4} \times 5 = 150$$

$$\text{Speed of sonu on Monday} = \frac{150}{3} = 50 \text{ km/h}$$

$$\text{Required \%} = \frac{54}{50} \times 100 = 108\%$$

**S56. Ans.(d)****Sol.**

$$\text{I. } 3x^2 - 10x + 8 = 0$$

$$3x^2 - 4x - 6x + 8 = 0$$

$$x(3x - 4) - 2(3x - 4) = 0$$

$$(x - 2)(3x - 4) = 0$$

$$x = 2, \frac{4}{3}$$

$$\text{II. } 5y^2 - 22y + 24 = 0$$

$$5y^2 - 10y - 12y + 24 = 0$$

$$5y(y - 2) - 12(y - 2) = 0$$

$$(5y - 12)(y - 2) = 0$$

$$y = \frac{12}{5}, 2$$

$$y \geq x$$

**S57. Ans.(c)****Sol.**

$$\text{I. } 4x^2 + 39x + 90 = 0$$

$$4x^2 + 24x + 15x + 90 = 0$$

$$4x(x + 6) + 15(x + 6) = 0$$

$$(4x + 15)(x + 6) = 0$$

$$x = -\frac{15}{4}, -6$$

$$\text{II. } 2y^2 - 3\sqrt{3}y - 15 = 0$$

$$2y^2 - 5\sqrt{3}y + 2\sqrt{3}y - 15 = 0$$

$$y(2y - 5\sqrt{3}) + \sqrt{3}(2y - 5\sqrt{3}) = 0$$

$$(y + \sqrt{3})(2y - 5\sqrt{3}) = 0$$

$$y = -\sqrt{3}, \frac{5\sqrt{3}}{2}$$

$$y > x$$



**S58. Ans.(a)****Sol.**

**I.**  $5x^2 - 36 = 12^2$

$5x^2 = 144 + 36$

$5x^2 = 180$

$x^2 = 36$

$x = \pm 6$

**II.**  $y^2 + 17y + 72 = 0$

$y^2 + 9y + 8y + 72 = 0$

$y(y + 9) + 8(y + 9) = 0$

$(y + 8)(y + 9) = 0$

$y = -8, -9$

$x > y$

**S59. Ans.(e)****Sol.**

**I.**  $1.5x^2 - 10x + 16 = 0$

$1.5x^2 - 4x - 6x + 16 = 0$

$x(1.5x - 4) - 4(1.5x - 4) = 0$

$(x - 4)(1.5x - 4) = 0$

$x = 4, \frac{4}{1.5}$

**II.**  $y^2 = 6y$

$y^2 - 6y = 0$

$y(y - 6) = 0$

$y = 0, 6$

No relation can be established between x &amp; y

**S60. Ans.(b)****Sol.**

**I.**  $2x^2 - 21x + 55 = 0$

$2x^2 - 10x - 11x + 55 = 0$

$2x(x - 5) - 11(x - 5) = 0$

$(2x - 11)(x - 5) = 0$

$x = \frac{11}{2}, 5$

**II.**  $5y^2 - 46y + 105 = 0$

$5y^2 - 25y - 21y + 105 = 0$

$5y(y - 5) - 21(y - 5) = 0$

$(5y - 21)(y - 5) = 0$

$y = \frac{21}{5}, 5$

$y \leq x$

**S61. Ans.(e)****Sol.**

Let rate = r%

ATQ,

$$\frac{20}{43} = \frac{P \left(1 + \frac{r}{100}\right) - P}{P \left(1 + \frac{r}{100}\right)^2 - P} = \frac{\frac{r}{100}}{\frac{r^2}{100^2} + \frac{r}{50}}$$

$$\Rightarrow \frac{20}{43} = \frac{\frac{1}{100}}{\frac{r + 200}{10000}}$$

$$\Rightarrow \frac{20}{43} = \frac{100}{r + 200}$$

$$\Rightarrow r = 15\%$$

Alternate Method.

Let Rs. (43 - 20) = Rs. 23 amount plus interest earn on Rs. 20

⇒ Rs. 3 interest earn on Rs. 20 ⇒ Rate = 15%

ATQ,

$$P + \frac{P \times 15 \times 4}{100} = 51,200$$

$$\Rightarrow 1.6P = 51,200$$

$$\Rightarrow P = 32,000$$

$$\text{Required Interest} = 32,000 \left[1 + \frac{15}{100}\right]^3 - 32,000$$

$$= 48,668 - 32,000$$

$$= 16,668$$

**S62. Ans.(d)****Sol.**

Let, the side of square = 2a

⇒ Diameter of circle = 2a

ATQ,

$$4a^2 - \frac{22}{7} \times a \times a = 262.5$$

$$\Rightarrow \frac{28a^2 - 22a^2}{7} = 262.5$$

$$\Rightarrow 6a^2 = 262.5 \times 7$$

$$\Rightarrow a^2 = 306.25$$

$$\Rightarrow a = 17.5 \text{ cm}$$

$$\text{Perimeter of circle} = 2 \times \frac{22}{7} \times a$$

$$= 2 \times \frac{22}{7} \times 17.5 = 110$$

Let, Breadth of rectangle = x

⇒ length of rectangle = 1.2x

ATQ,

$$2(1.2x + x) = 110$$

$$\Rightarrow x = \frac{55}{2.2} = 25$$

$$\text{Required area} = 1.2 \times 25 \times 25 = 750 \text{ cm}^2$$

TEST SERIES

Bilingual

VIDEO SOLUTIONS



# IBPS CLERK 2019 PRELIMS

## 35 TOTAL TESTS

### Validity : 12 Months



**S63. Ans.(b)**

**Sol.** Let A, B, C and D can complete the work alone in a, b, c and d days respectively. Let 't' be the time in which the work is completed.

ATQ,

$$\frac{20}{a} + \frac{12}{b} + \frac{t}{c} + \frac{t-15}{d} = 1$$

$$\text{and, } \frac{20}{a} = \frac{12}{b} = \frac{t}{c} = \frac{t-15}{d} = \frac{1}{4}$$

$$\Rightarrow a = 80 \text{ and } b = 48$$

$$\text{and, } \frac{1}{a} + \frac{1}{c} = \frac{1}{48}$$

$$\Rightarrow \frac{1}{c} = \frac{1}{48} - \frac{1}{80} = \frac{1}{120}$$

$$\Rightarrow c = 120$$

$$\frac{t}{c} = \frac{1}{4} \Rightarrow t = 30$$

$$\frac{t-15}{d} = \frac{1}{4} \Rightarrow d = 15 \times 4 = 60$$

Required unit of the work in one day

$$= \frac{1}{80} + \frac{1}{48} + \frac{1}{60}$$

$$= \frac{3+5+4}{240}$$

$$= \frac{12}{240} = \frac{1}{20}$$

Required number of days = 20 days

**S64. Ans.(b)**

**Sol.** Let the number which is reversed is "10a + b"

If it is reversed then the number becomes "10b+a"

ATQ,

$$10b + a - 10a - b = 5 \times 5.4$$

$$\Rightarrow 9b - 9a = 27$$

$$\Rightarrow b - a = 3$$

Numbers can be 14, 25, 36, 47, 58 and 69 but all the five digits are multiple of 4

$\Rightarrow$  The number should be 36

**S65. Ans.(a)**

**Sol.** Let initially strength = x

ATQ,

Total weight  $\rightarrow 20x$

When two persons include

Total weight = 22 (x + 2)

Weight of two persons included = 2x + 44

4 persons excluded weight

$$= \frac{2x + 44}{2} = x + 22$$

ATQ,

$$22(x + 2) - (x + 22) = (x + 2 - 4) \times 25$$

$$x = 18$$

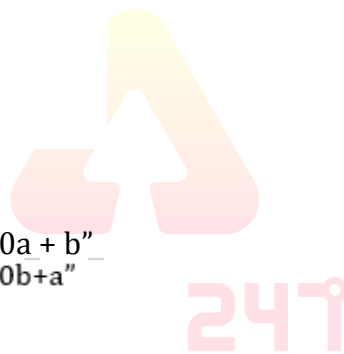

**S66. Ans.(b)****Sol.**

Let cost price per kg of rice = 100

Mark price per kg of rice = 150

$$\text{Discounted price per kg of rice} = 150 \times \frac{250}{300}$$

$$= 125$$

Amount priced by customer =  $500 \times 125 = 62500$ 

50 kg rice given free on 500 kg rice

Total cost price retailer has to bear if he weighs 20% less

$$= \frac{550 \times 800}{1000} \times 100$$

$$= 44,000$$

$$\text{Profit \%} = \frac{62500 - 44000}{44000} \times 100$$

$$= \frac{185}{440} \times 100$$

$$= 42 \frac{1}{22} \%$$

**S67. Ans.(c)****Sol.**

Let C.P. of 1 bat = x

C.P. of 1 ball = y

**From A)**

S.P. of 1 ball =  $\frac{3x}{4}$

S.P. of 1 bat =  $1.5x$

**From B)**

S.P. of 1 bat =  $1.5x$

S.P. of 1 ball =  $0.6y$

Using **statement, A** and **B** together question can be solved.**S68. Ans.(a)****Sol.** Let, total number of balls = a**From A)**

$$\frac{4}{a} \times \frac{3}{a-1} = \frac{1}{20}$$

$$\Rightarrow 240 = a(a-1)$$

$$\Rightarrow a = 16$$

$$a = 4 + x + 5 + y$$

$$\Rightarrow x + y = 16 - 9 = 7$$

**From B)**

$$x + 5 = \frac{9 + x + y}{2}$$

$$\Rightarrow 2x + 10 = 9 + x + y$$

$$\Rightarrow x = y - 1$$

Only **statement 'A'** is sufficient to answer the question.

S69. Ans.(a)

Sol.

**From A)**

$$w^{2n} > w^n$$

For value of  $n < 0$ , above condition isn't satisfied

$\therefore n$  should always be greater than 1  $\Rightarrow n$  is a positive integer.

**From B)**

$$n^{2w} > n^w$$

For  $n = -2, 3$

For negative as well positive value this condition

can be satisfied depend upon whether 'w' is even or odd

So, only B is not sufficient to answer the question.

Hence, only **statement 'A'** is sufficient to answer the question.

S70. Ans.(b)

Sol.

Let, number of persons in the group =  $n$

Total weight =  $16n$

**From A)**

Total weight now =  $16n - 16 = 16(n - 1)$

**From B)**

Total weight =  $18(n + 2) = 16n + 16 + 28$

$$\Rightarrow 2n = 44 - 36$$

$$\Rightarrow n = \frac{8}{2} = 4$$

Only **statement 'B'** is sufficient to answer the question.

S71. Ans.(b)

Sol.

Let Radius of sphere and cylinder =  $r$

So,

Height of cuboid =  $\frac{2r}{2} = r =$  radius of cone

ATQ—

$$\frac{\text{Volume of cylinder}}{\text{Volume of sphere}} \times 100 = 75\%$$

$$\frac{\pi r^2 h}{\frac{4}{3} \pi r^3} \times 100 = 75$$

$h = r =$  height of cylinder

Let edge of cube and height of cone =  $a$

So, ATQ

$$\frac{\text{Volume of cube}}{\text{Volume of cone}} \times 100 = 95 \frac{5}{11} \%$$

$$\frac{a^3}{\frac{1}{3} \times \frac{22}{7} \times r^2 \times a} \times 100 = \frac{1050}{11} \%$$

$$a^2 = \frac{1050}{1100} \times \frac{22}{7} \times \frac{1}{3} \times r^2$$

$$a = r$$

adda247

Ratio of volume of cube and cuboid.

$$\frac{a^3}{r \times 110} = \frac{441}{110}$$
$$\frac{r^3}{r} = 441$$
$$r = 21\text{cm}$$

$$\text{Surface area of sphere} = 4\pi r^2$$
$$= 4 \times \frac{22}{7} \times 21 \times 21$$
$$= 5544 \text{ cm}^2$$

**S72. Ans.(e)**

**Sol. \**

Let Radius of sphere and cylinder = r

So,

Height of cuboid =  $\frac{2r}{2} = r =$  radius of cone

ATQ—

$$\frac{\text{Volume of cylinder}}{\text{Volume of sphere}} \times 100 = 75\%$$

$$\frac{\pi r^2 h}{\frac{4}{3} \pi r^3} \times 100 = 75$$

$h = r =$  height of cylinder

Let edge of cube and height of cone = a

So, ATQ

$$\frac{\text{Volume of cube}}{\text{Volume of cone}} \times 100 = 95 \frac{5}{11} \%$$

$$\frac{a^3}{\frac{1}{3} \times \frac{22}{7} \times r^2 \times a} \times 100 = \frac{1050}{11} \%$$

$$a^2 = \frac{1050}{1100} \times \frac{22}{7} \times \frac{1}{3} \times r^2$$

$a = r$

Ratio of volume of cube and cuboid.

$$\frac{a^3}{r \times 110} = \frac{441}{110}$$
$$\frac{r^3}{r} = 441$$
$$r = 21\text{cm}$$

$$\text{Required \%} = \frac{6a^2}{2\pi rh + 2\pi r^2}$$

$$\text{Required \%} = \frac{6 \times 21 \times 21}{2 \times \frac{22}{7} \times 21 \times 21 + 2 \times \frac{22}{7} \times 21 \times 21} \times 100$$

$$= 47 \frac{8}{11} \%$$



**Special Offer**

**IBPS RRB PO  
MAINS 2019**

**35 MOCK PAPERS**

**Validity : 1 Month**

**S73. Ans.(a)****Sol.**

Let Radius of sphere and cylinder = r

So,

Height of cuboid =  $\frac{2r}{2} = r =$  radius of cone

ATQ—

$$\frac{\text{Volume of cylinder}}{\text{Volume of sphere}} \times 100 = 75\%$$

$$\frac{\pi r^2 h}{\frac{4}{3} \pi r^3} \times 100 = 75$$

h = r = height of cylinder

Let edge of cube and height of cone = a

So, ATQ

$$\frac{\text{Volume of cube}}{\text{Volume of cone}} \times 100 = 95 \frac{5}{11} \%$$

$$\frac{a^3}{\frac{1}{3} \times \frac{22}{7} \times r^2 \times a} \times 100 = \frac{1050}{11} \%$$

$$a^2 = \frac{1050}{1100} \times \frac{22}{7} \times \frac{1}{3} \times r^2$$

a = r

Ratio of volume of cube and cuboid.

$$\frac{a^3}{r \times 110} = \frac{441}{110}$$

$$\frac{r^3}{r} = 441$$

r = 21cm

Required ratio

$$\frac{4}{3} \pi r^3 : \frac{1}{3} \pi r^2 \times r : \pi r^2 \times 2r$$

4 : 1 : 3

**S74. Ans.(c)****Sol.**

Let Radius of sphere and cylinder = r

So,

Height of cuboid =  $\frac{2r}{2} = r =$  radius of cone

ATQ—

$$\frac{\text{Volume of cylinder}}{\text{Volume of sphere}} \times 100 = 75\%$$

$$\frac{\pi r^2 h}{\frac{4}{3} \pi r^3} \times 100 = 75$$

h = r = height of cylinder

Let edge of cube and height of cone = a

So, ATQ

$$\frac{\text{Volume of cube}}{\text{Volume of cone}} \times 100 = 95 \frac{5}{11} \%$$

$$\frac{a^3}{\frac{1}{3} \times \frac{22}{7} \times r^2 \times a} \times 100 = \frac{1050}{11} \%$$

$$a^2 = \frac{1050}{1100} \times \frac{22}{7} \times \frac{1}{3} \times r^2$$

$$a = r$$

Ratio of volume of cube and cuboid.

$$\frac{a^3}{r \times 110} = \frac{441}{110}$$

$$\frac{r^3}{r} = 441$$

$$r = 21 \text{ cm}$$

$$\text{Volume of cone} = \frac{1}{3} \times \frac{22}{7} \times 21 \times 21 \times 21 = 9702 \text{ cm}^3$$

$$\text{Volume of cuboid} = 21 \times 110 = 2310$$

$$\text{Required sum} = 12012 \text{ cm}^3$$

**S75. Ans.(e)**

**Sol.**

Let Radius of sphere and cylinder = r

So,

$$\text{Height of cuboid} = \frac{2r}{2} = r = \text{radius of cone}$$

ATQ—

$$\frac{\text{Volume of cylinder}}{\text{Volume of sphere}} \times 100 = 75\%$$

$$\frac{\pi r^2 h}{\frac{4}{3} \pi r^3} \times 100 = 75$$

$$h = r = \text{height of cylinder}$$

Let edge of cube and height of cone = a

So, ATQ

$$\frac{\text{Volume of cube}}{\text{Volume of cone}} \times 100 = 95 \frac{5}{11} \%$$

$$\frac{a^3}{\frac{1}{3} \times \frac{22}{7} \times r^2 \times a} \times 100 = \frac{1050}{11} \%$$

$$a^2 = \frac{1050}{1100} \times \frac{22}{7} \times \frac{1}{3} \times r^2$$

$$a = r$$

Ratio of volume of cube and cuboid.

$$\frac{a^3}{r \times 110} = \frac{441}{110}$$

$$\frac{r^3}{r} = 441$$

$$r = 21 \text{ cm}$$





$$\begin{aligned} \text{C. S. A. of cone} &= \frac{22}{7} \times 21\sqrt{21^2 + 21^2} \\ &= \frac{22}{7} \times 21 \times 21 \times \sqrt{2} \\ &= 1386\sqrt{2} \text{ cm}^2 \end{aligned}$$

**S76. Ans.(a)**

**Sol.** (Airtel + Maruti) = 315% of Tata Investment

$$= 315 \times 200 = 63000 \text{ cr}$$

$$\text{Airtel} = 63000 \times \frac{5}{9} = 35000 \text{ cr}$$

$$\text{Maruti} = 63000 \times \frac{4}{9} = 28000 \text{ cr}$$

$$\text{Total Profit} = 7500 \times \frac{132}{100} = 9900 \text{ cr}$$

$$\text{Airtel : Maruti} = 35000 \times 8 : 28000 \times 12 \\ = 5 : 6$$

Profit share of Airtel

$$= 9900 \times \frac{5}{11} = 4500 \text{ cr}$$

Profit share of Maruti

$$= 9900 \times \frac{6}{11} = 5400 \text{ cr}$$

**S77. Ans.(b)**

**Sol.** Total and Wipro contribute 40% of total profit

⇒ Remaining three companies contributes 60% of total profit

If Airtel and Maruti invested same amount

then ratio between profit share of Airtel and Maruti is 8 : 12 → 2 : 3

Profit share of Airtel, Mahindra and Maruti is → 2 : 1 : 3

Let amount invested by Airtel = 'y'

ATQ,

$$\frac{y \times 8}{15,000 \times 10} = \frac{2}{1}$$

$$\Rightarrow y = 37,500$$

Total amount invested by Maruti and TATA together

$$= 20,000 + 37,500 = 57,500 \text{ cr}$$

**S78. Ans.(b)**

**Sol.** Investment of Maruti = Tata ×  $\frac{120}{100}$

$$= 20000 \times \frac{120}{100} = 24000 \text{ cr}$$

$$\text{Profit of Maruti} = 10000 \times \frac{80}{100}$$

$$= 8000 \text{ cr}$$

According to question

$$\frac{8000}{7500} = \frac{24000 \times 12}{20000 \times T}$$

$$T = 13\frac{1}{2} \text{ months}$$

$$\text{Difference} = 13\frac{1}{2} - 12 = 1\frac{1}{2} \text{ months}$$

TEST SERIES

Bilingual



**FCI 2019  
Manager Phase-I**

**30 TOTAL TESTS**

**Validity : 12 Months**

**S79. Ans.(c)****Sol.**

$$\begin{aligned} \text{Profit of Maruti and Mahindra} \\ &= 10000 \times \frac{137.5}{100} \text{ and } 10000 \times \frac{112.5}{100} \\ &= 13750 \text{ cr and } 11250 \text{ cr} \end{aligned}$$

According to question

$$\begin{aligned} \frac{11250}{13750} &= \frac{15000 \times 18}{X \times 12} \\ \frac{9}{9} &= \frac{15000 \times 3}{2X} \end{aligned}$$

$$X = \frac{55000}{2}$$

$$= 27500 \text{ cr}$$

$$\text{Required ratio}\% = \frac{27500 - 15000}{15000} \times 100$$

$$= 83\frac{1}{3}\%$$

**S80. Ans.(d)****Sol.**

$$\text{Total Investment amount} = 20000 \times 5 = 100000 \text{ cr}$$

$$\text{Total Investment of (Airtel + Wipro + Maruti)}$$

$$= 100000 - (20000 + 15000)$$

$$= 65000 \text{ cr}$$

$$\text{Share of Investment (Airtel : Wipro : Maruti)} = 4 : 6 : 3$$

$$= 65000 \times \frac{4}{13}, 65000 \times \frac{6}{13}, 65000 \times \frac{3}{13}$$

$$= 20000, 30000, 15000$$

Profit of Airtel

$$\begin{aligned} &= \frac{20000 \times 8}{20000 \times 12} = \frac{X}{7500} \\ \Rightarrow X &= 5000 \text{ cr} \end{aligned}$$

$$\text{Profit of Maruti} = \frac{20000 \times 12}{15000 \times 12} = \frac{7500}{X}$$

$$\Rightarrow X = 5625 \text{ cr}$$

$$\text{Total profit} = 5000 + 5625 = 10625 \text{ cr}$$

**S81. Ans.(b)**

**Sol.** Option (b) is the correct choice. The author in the first paragraph mentions how if we didn't have the bodily reactions to emotions, we'd essentially be thinking of them as sad thoughts i.e. just cognition without actually feeling anything. And hence, according to the author it is not possible to experience emotion without having a physiological reaction.

**S82. Ans.(c)**

**Sol.** Option (c) is the correct choice. The exchange of gifts is raised to a fine art 'with a corresponding calibration of emotions'. To calibrate something is to process or adjust something by comparing it with a standard. Hence calibration of emotions would mean to processing of emotions and adjudged by comparison.

**S83. Ans.(d)**

**Sol.** Option (d) is the correct choice. The third paragraph clearly states that the author and his wife did not have as much trouble acclimatizing to the tropical temperature and isolation as much trouble they had in acclimatizing themselves to the ill-humoured emotions around gift-giving.

**S84. Ans.(d)**

**Sol.** Option (d) is the correct choice. While on the surface, most of these options seem correct, the best answer would be 'exchange and affect'. Exchange and affect essentially has the same meaning as cause-effect and because the author is talking about an indirect link between to actions, echange and affect fit the blank in the best manner

**S85. Ans.(e)**

**Sol.** Option (e) is the correct choice. All the options a), b) and c) can be inferred from the second paragraph, 'imagine an emotion without its cultural and social context – the warp and weft of its occurrence, **its very form and meaning**'

**S86. Ans.(d)**

**Sol.** Option (d) is the correct choice. Sublime means something of very great excellence and beauty. Deplorable, unpardonable, grievous, diabolical and abysmal are all synonyms which mean something that is sad, unpleasant and pathetic.

**S87. Ans.(c)**

**Sol.** Option (c) is the correct choice. Amicable is someone that is characterised by friendliness and absence of discord. Virulent, rancorous, acrimonious and mordant all refer to feelings of bitterness and hostility.

**S88. Ans.(e)**

**Sol.** Option (e) is the correct choice. To calibrate means to carefully check and compare and essentially has the same meaning as weigh, measure process and weigh. Hence e) i.e. guess is the correct option.

**S89. Ans.(a)**

**Sol.** Option (a) is the correct choice. Rejoinder and riposte both refer to an answer or a reply while all the others refer to a question.

**S90. Ans.(a)**

**Sol.** Option (a) is the correct choice. Outlier means a place that is far removed from the main place and has the same meaning as distant. Obnoxious means annoying. Inconsequential means something that has little or no consequence on the future. Succinct means to the point. Exhausting means very tiring.

**S91. Ans.(d)**

**Sol.** Among the given paragraphs, we can infer the highlighted statement from [II] and [III]. Both the paragraphs discuss the SEBI's new regulations for attracting higher investment to India. The paragraph [I] only discusses the recent decision taken by the Central government with regard to FPIs. Hence, option (d) is the most suitable answer choice.

**S92. Ans.(a)**

**Sol.** Among the given options, all the three paragraphs discuss the drug developed for treating tuberculosis. But, it is only in paragraph [II] where we find the reference for the need to keep the prices of the drug under control such that the higher number of patients could get access to them especially in the developing countries. Hence, option (a) is the most suitable answer choice.

**S93. Ans.(b)**

**Sol.** Option (b) is the correct choice. Relegate means to send someone down in rank while delegate means to send someone in your place to perform a task. Hence delegate needs to be changed to delegate to make the sentence meaningfully and contextually correct.

**S94. Ans.(a)**

**Sol.** Option (a) is the correct choice. The correct spelling of irreverant is irreverent which means showing a lack of respect for people or things that are generally taken seriously.

**S95. Ans.(d)**

**Sol.** Option (d) is the correct choice. The correct spelling of convivial is convivial which means friendly, lively, and enjoyable. The rest are correct in their usage and spellings.

**S96. Ans.(a)**

**Sol.** Option (a) is the correct choice. Ordinance refers to a rule or a law while ordnance refers to guns and arms. Hence ordnance needs to be changed to ordinance to make the sentence meaningfully and contextually correct. Dissentient is an adjective describing someone in opposition to a majority or official opinion.

**S97. Ans.(e)**

**Sol.** Option (e) is the correct choice. All the words are spelt correctly and fit the sentence contextually as well. Counsel refers to a barrister or other legal adviser conducting a case. It also refers to advice especially that given formally.

**S98. Ans.(a)**

**Sol.** Option (a) is the correct choice. Censor means to edit or cut out a piece of a book, film etc. Censure on the other hand means to express severe disapproval of someone or something. Hence, 'censored' needs to be replaced by 'censured' to make the sentence meaningfully and contextually correct.

**S99. Ans.(a)**

**Sol.** Option (a) is the correct choice. Accommodate has been wrongly spelt as accomadate.

**S100. Ans.(c)**

**Sol.** Option (c) is the correct choice. Phase just means a stage or a period in a series of events while faze means to unnerve or disturb. Hence, phase needs to be changed to faze to make the sentence meaningfully and contextually correct.

## IBPS RRB Clerk Mains

### Memory Based Practice Set

- Based on RRB PO Mains
- GA + COMPUTER

Bilingual

**S101. Ans.(c)**

**Sol.** Option (c) is the correct choice. According to the rule of parallelism and the correct usage of the phrase Not Only.... But Also, he not only visited Paris needs to be written as he visited not only Paris in order to make the sentence grammatically correct.

**S102. Ans.(c)**

**Sol.** Option (c) is the correct choice. The sous chef and wine expert is the same person as can be understood by the absence of article before 'wine expert' and hence the 'are' in part (c) needs to be changed to 'is' in order to make the sentence grammatically correct.

**S103. Ans.(c)**

**Sol.** Option (c) is the correct choice. Since the first action of the sentence 'had prepared' is in the past perfect tense, the following actions must also be in the past perfect tense. Hence 'chose' needs to be changed to 'chosen' in order to make the sentence grammatically correct.

Note: The auxiliary 'had' need not be mentioned with the second and third verb phrases.

**S104. Ans.(c)**

**Sol.** Option (c) is the correct choice. Among is used when three or more persons or things are involved, while between is used when two persons or things are involved. Hence, 'among' needs to change to 'between' in order to make the sentence grammatically correct.

**S105. Ans.(d)**

**Sol.** Option (d) is the correct choice. 'Bear Down' is a phrasal verb which means 'to overthrow' and their correct usage in the past tense would be 'bore down' and not 'beared down'.

**S106. Ans.(d)**

**Sol.** The given passage is regarding the present crisis faced by the Mumbai's Monorail system. The statement (D) is the most suitable statement to start the passage as it introduces to the present situation of the Monorail which is an example of failed urban planning. Further, the statement will be followed by statement (A), which mentions the expenses undertaken for building it and is causes of the failure. Statement (A) will then be followed by statement (C), which mentions that MMRDA is planning to revive the system. It will then be followed by statement (F), which mentions new vendor policy, which is how MMRDA plans to revive the Monorail. Further, statement (B) will follow statement (F), which explains the repercussions of 'non availability of spare parts', which has been mentioned in the later part of statement (F). Hence, the correct sequence of the statements will be **DACFB**. Among the given statements, only statement (E) does not fit in the logical sequence.

Hence, option (d) is the most suitable answer choice.

**S107. Ans.(e)**

**Sol.** The given passage is regarding the present crisis faced by the Mumbai's Monorail system. The statement (D) is the most suitable statement to start the passage as it introduces to the present situation of the Monorail which is an example of failed urban planning. Further, the statement will be followed by statement (A), which mentions the expenses undertaken for building it and is causes of the failure.

Statement (A) will then be followed by statement (C), which mentions that MMRDA is planning to revive the system. It will then be followed by statement (F), which mentions new vendor policy, which is how MMRDA plans to revive the Monorail. Further, statement (B) will follow statement (F), which explains the repercussions of 'non availability of spare parts', which has been mentioned in the later part of statement (F). Hence, the correct sequence of the statements will be **DACFB**. Among the given statements, only statement (E) does not fit in the logical sequence.

Hence, option (e) is the most suitable answer choice.

**S108. Ans.(a)**

**Sol.** The given passage is regarding the present crisis faced by the Mumbai's Monorail system. The statement (D) is the most suitable statement to start the passage as it introduces to the present situation of the Monorail which is an example of failed urban planning. Further, the statement will be followed by statement (A), which mentions the expenses undertaken for building it and is causes of the failure. Statement (A) will then be followed by statement (C), which mentions that MMRDA is planning to revive the system. It will then be followed by statement (F), which mentions new vendor policy, which is how MMRDA plans to revive the Monorail. Further, statement (B) will follow statement (F), which explains the repercussions of 'non availability of spare parts', which has been mentioned in the later part of statement (F). Hence, the correct sequence of the statements will be **DACFB**. Among the given statements, only statement (E) does not fit in the logical sequence.

Hence, option (a) is the most suitable answer choice.

**S109. Ans.(b)**

**Sol.** Among the given options, statement (b) can well conclude the paragraph as it mentions the further steps that MMRDA plans to take to revive Mumbai's Monorail. It mentions how the authority plans to solve the biggest problem faced by Monorail which is of non-availability of critical parts. Hence, option (b) is the most suitable answer choice.

**S110. Ans.(b)**

**Sol.** The given passage is regarding the present crisis faced by the Mumbai's Monorail system. The statement (D) is the most suitable statement to start the passage as it introduces to the present situation of the Monorail which is an example of failed urban planning. Further, the statement will be followed by statement (A), which mentions the expenses undertaken for building it and is causes of the failure. Statement (A) will then be followed by statement (C), which mentions that MMRDA is planning to revive the system. It will then be followed by statement (F), which mentions new vendor policy, which is how MMRDA plans to revive the Monorail. Further, statement (B) will follow statement (F), which explains the repercussions of 'non availability of spare parts', which has been mentioned in the later part of statement (F). Hence, the correct sequence of the statements will be **DACFB**. Among the given statements, only statement (E) does not fit in the logical sequence.

Hence, option (b) is the most suitable answer choice.

**S111. Ans.(b)**

**Sol.** Option (b) is the correct choice. Shed light is a phrasal verb which means to make something clear by way of providing more information. Hence shed is the only word that can be used.



**S112. Ans.(a)**

**Sol.** Option (a) is the correct choice. Touchdown has the same meaning as landing and hence is a perfect fit for the blank. Splashdown is the alighting of a returning spacecraft on the sea, with the assistance of parachutes. Arrival and landfall don't make any sense in this context.

**S113. Ans.(d)**

**Sol.** Option (d) is the correct choice. Probe refers to a small unmanned spacecraft and hence fits the blank perfectly. Quest refers to a mission and hence does not make sense here. Here, we will also omit 'invention' because no such process has happened.

Dockyard: an area with docks and equipment for repairing and maintaining ships.

**S114. Ans.(b)**

**Sol.** Option (b) is the correct choice. Desolate here is used as an adjective which refers to a place devoid of inhabitants and visitors : deserted.

Disconsolate: very unhappy and unable to be comforted.

Oppress: keep (someone) in subjection and hardship, especially by the unjust exercise of authority.

Persecute: harass or annoy (someone) persistently

**S115. Ans.(c)**

**Sol.** Option (c) is the correct choice. Pristine refers to something that is in its original condition; unspoilt. While grammatically there is nothing wrong with beautiful and lovely materials, they do not fit the sentence on a contextual basis. Mint materials also does not make sense.

Fraudulent: obtained, done by, or involving deception, especially criminal deception.

Shifty: (of a person or their manner) appearing deceitful or evasive

**S116. Ans.(c)**

**Sol.** Option (c) is the correct choice. Crater is a large bowl-shaped cavity in the ground of a celestial object and hence fits perfectly. Dents cannot be used as it is in the plural form.

Stint: a person's fixed or allotted period of work./ limitation of supply or effort.

**S117. Ans.(d)**

**Sol.** Option (d) is the correct choice, because the sentence ends with 'of the mission'. And hence only ahead can be used to complete the sentence.

**S118. Ans.(b)**

**Sol.** Option (b) is the correct choice. Only 'briefly' can be used in this sentence. Long and just don't make grammatical sense Shortly means quickly and not for a short time and hence it cannot be used.

**S119. Ans.(a)**

**Sol.** Option (a) is the correct choice. 'Precious materials already gathered during its first landing' makes sense. While distributed would not have fit the sentence because it talks about losing something. Encompass means surround and have or hold within and hence does not fit here. Accustom means getting used to and also doesn't fit here.

**S120. Ans.(c)**

**Sol.** Option (c) is the correct choice. A surface is usually covered and not surrounded by something. The surface could not have been 'submerged' under the materials because submerge means to go under water. Authenticated means prove or show (something) to be true, genuine, or valid

**S121. Ans.(c)**

**S122. Ans.(a)**

**Sol.** A data warehouse is a relational database that is designed for query and analysis rather than for transaction processing. It usually contains historical data derived from transaction data, but it can include data from other sources. It separates analysis workload from transaction workload and enables an organization to consolidate data from several sources.

**S123. Ans.(c)**

**S124. Ans.(c)**

**Sol.** I/O Device or Input Output device can both feed data into and accept data from a computer.

**S125. Ans.(c)**

**Sol.** Smallest to largest: Character, Field, Record, File, Database

**S126. Ans.(a)**

**Sol.** EPROM is generally erased by using ultraviolet rays

**S127. Ans.(b)**

**Sol.** DRAM stands for Dynamic Random Access Memory.

**S128. Ans.(a)**

**Sol.** Those commands, options are available in menu bar.

**S129. Ans.(a)**

**Sol.** In Word 2010, a document is saved with the .docx extension by default.

**S130. Ans.(e)**

**Sol.** Applications software (also called end-user programs) include such things as database programs, word processors, Web browsers and spreadsheets, MS Office suite. An application program is a computer program designed to perform a group of coordinated functions, tasks, or activities for the benefit of the user.

**S131. Ans.(b)**

**Sol.** A device driver is a program that controls a particular type of device that is attached to your computer. There are device drivers for printers, displays, CD-ROM readers, diskette drives, and so on. When you buy an operating system, many device drivers are built into the product



**S132. Ans.(c)**

**Sol.** Information is organised or classified data which has some meaningful values for the receiver.

**S133. Ans.(a)**

**Sol.** Trojan horse is a malicious program which looks like a normal program and is accompanied with useful applications like computer games. When you run the game, the Trojan horse gets activated and destroys the information in the background.

**S134. Ans.(c)**

**Sol.** Spider is an important element of a search engine that browses the Internet in a systematic manner.

**S135. Ans.(b)**

**Sol.** Common Business Oriented language (COBOL) is mainly used for developing commercial applications.

**S136. Ans.(a)**

**Sol.** Query allows us to access certain records in database.

**S137. Ans.(d)**

**Sol.** The transport layer is a conceptual division of methods in the layered architecture of protocols in the network stack in the Internet Protocol Suite and the Open Systems Interconnection (OSI). The protocols of the layer provide host-to-host communication services for applications

**S138. Ans.(a)**

**Sol.** Twisted pair wires are used in telephone networks and for digital data transmission over short distances up to 1 km.

**S139. Ans.(b)**

**Sol.** MySQL Community Server is the world's most popular open source database. MySQL is one of the best RDBMS being used for developing web-based software applications

**S140. Ans.(e)**

**Sol.** The most notable system software is the operating system that controls the PC; other types of system software include device drivers, system utilities, compilers, file management tools, assemblers and debuggers. Typically installed in the computer during the installation of the operating system.

**S141. Ans.(c)**

**Sol.** Authentication is a process that ensures and confirms a user's identity.

**S142. Ans.(d)**

**Sol.** Source program is written in high level language.

**S143. Ans.(c)**

**Sol.** Supercomputer is used for predicting the weather.

TEST SERIES  
Bilingual

**LIC ASSISTANT  
PRELIMS**  
30 TOTAL TESTS

Validity : 12 Months

**S144. Ans.(d)**

**Sol.** optical fiber, co-axial cable and twisted pair wire are example of guided medium. Micro waves are unguided medium.

**S145. Ans.(e)**

**Sol.** Visual basic is the programming language of Excel and other office programs like create a macro, msgbox, workbook and worksheet object etc.

**S146. Ans.(d)**

**Sol.** 1 nibble= 4 bits

**S147. Ans.(e)**

**Sol.** Record is the correct answer, as it is not in the given options none of these is correct.

**S148. Ans.(e)**

**Sol.** E-commerce is the process of trading goods over the internet.

**S149. Ans.(b)**

**Sol.** Alpha was android version 1.0 released on 23rd September 2008. Android is continually developed by Google and the Open Handset Alliance (OHA), and has seen a number of updates to its base operating system since the initial release.

**S150. Ans.(b)**

**Sol.** Internet Explorer is an Application Software.

**S151. Ans.(a)**

**Sol.** BIOS is a set of programs that are hardcoded on a chip to load into ROM at startup. Short for Basic Input/Output System, the BIOS is a ROM chip located on all motherboards that allows you to access and set up your computer system at the most basic level.

**S152. Ans.(b)**

**Sol.** Computer allows user to input data, and by user's inputs it gathers data.

**S153. Ans.(c)**

**Sol.** MARK-1 invented was by Howard Aiken.

**S154. Ans.(d)**

**Sol.** A computer system includes hardware components, software, peripheral devices.

**S155. Ans.(b)**

**Sol.** The unit that stores all the data and information of a computer system is known as the memory or storage unit.

**S156. Ans.(b)**

**Sol.** Virtual reality basically means 'near-reality'; it usually refers to a specific type of reality emulation which is simulated experience generated by a computer.

**S157. Ans.(e)**

**Sol.** Video Card is an expansion card which generates a feed of output images to a display

**S158. Ans.(a)**

**Sol.** Output Devices lets users to view or print data, for example: Monitor (screen display), Printer.

**S159. Ans.(d)**

**Sol.** The three important elements of a search engine are spiders or Web crawlers, indexing software and search algorithm.

**S160. Ans.(c)**

**Sol.** The abacus (plural abaci or abacuses), also called a counting frame, is a calculating tool with a set of beads for counting.

**S161. Ans.(c)**

**Sol.** Two-time Olympic gold medalist Keshav Dutt and former India football captain Prasun Banerjee conferred the 'Mohun Bagan Ratna' during its annual day celebrations on July 29

**S162. Ans.(b)**

**Sol.** Till 2002, the Government securities market was mainly a telephone market. Buyers and sellers traded over telephone and submitted physical Subsidiary General Ledger (SGL) transfer forms for transfer of the Government securities and cheques for settlement of the funds to the Reserve Bank of India. These manual operations were inefficient and often resulted in delays. In order to improve efficiency in the market, the Reserve Bank of India took steps to automate the process of trading and settlement of Government securities transactions and the Negotiated Dealing System (NDS) was introduced in February 2002.

**S163. Ans.(c)**

**Sol.** The International Cricket Council, ICC has suspended Zimbabwe Cricket with immediate effect over violation of global body's constitution which doesn't allow any government intervention. The current elected members of Zimbabwe Board were suspended by government agency Sports and Recreation Committee (SRC) which was a violation of relevant articles of ICC Constitution.

**S164. Ans.(a)**

**Sol.** The Kisan Credit Card (KCC) scheme is a credit scheme introduced in August 1998 by Indian banks. This model scheme was prepared by the National Bank for Agriculture and Rural Development (NABARD) on the recommendations of R.V.GUPTA to provide term loans and agricultural needs.

**S165. Ans.(c)**

**Sol.** The newly appointed Governor of Madhya Pradesh Lalji Tandon took oath at a function at Raj Bhavan.

**S166. Ans.(c)**

**Sol.** Union Minister of Finance and Corporate Affairs chaired the 20th Meeting of the Financial Stability and Development Council (FSDC) held in New Delhi.

**S167. Ans.(b)**

**Sol.** Justice Raghavendra Singh Chauhan was sworn in as the Chief Justice of Telangana High Court.

**S168. Ans.(a)**

**Sol.** Bandhan Bank Limited is an Indian banking and financial services company headquartered in Kolkata, West Bengal. Bandhan, which started as a micro-finance company in 2001, received banking license by Reserve Bank of India in 2014.

**S169. Ans.(a)**

**Sol.** Import substitution is a trade and economic policy which advocates replacing foreign imports with domestic production.

**S170. Ans.(d)**

**Sol.** Disinflation is a slowing in the rate of price inflation. It is used to describe instances when the inflation rate has reduced marginally over the short term. Although it is used to describe periods of slowing inflation, disinflation should not be confused with deflation, which can be harmful to the economy.

**S171. Ans.(b)**

**Sol.** Digital payments company Paytm, in association with Citibank, launched its first credit card called Paytm First Card. Paytm First Card comes with unlimited cash back and will be accepted in India as well globally.

**S172. Ans.(d)**

**Sol.** Japan has started testing its new generation bullet train Alfa-X, capable of reaching a top speed of 400 kilometres per hour.

**S173. Ans.(a)**

**Sol.** The Reserve Bank of India (RBI) released its statement on 'Payment and Settlement Systems in India: Vision 2019–2021', which outlined the measures that the central bank will undertake to foster innovation, cybersecurity, financial inclusion, customer protection, and competition

**S174. Ans.(c)**

**Sol.** Pakistan announced career diplomat Mueenul Haq as its new High Commissioner to India.

**S175. Ans.(c)**

**Sol.** State-run telco BSNL has joined hands with internet major Google to expand its WiFi footprint across the country. The telco said that the new initiative will help the customers to use BSNL high speed internet services on WiFi.

**Special Offer**

**IBPS RRB PO  
MAINS 2019**

**35 MOCK PAPERS**

**Validity : 1 Month**

**S176. Ans.(c)**

**Sol.** The Insurance Regulatory and Development Authority of India (IRDAI) has set up a committee to review the regulatory framework on microinsurance and recommend measures to increase the demand for such products. It is a 13-member panel chaired by IRDAI's Executive Director Suresh Mathur, and comprises of representatives from IRDAI, life, general and health insurance companies in public and private sectors and NGOs.

**S177. Ans.(c)**

**Sol.** If you have a current or a savings bank account and have not done any transactions through it for more than 12 months, then it will be classified as an inactive account. And if you don't do any transactions from a bank account for 24 months, then it will be classified as dormant.

**S178. Ans.(a)**

**Sol.** The minimum deposit required to open an FD varies from banks to banks and ranges between Rs. 1,000 to Rs. 10,000. There is no upper limit. For instance, the minimum amount that can be deposited in State Bank of India is Rs. 1,000.

**S179. Ans.(a)**

**Sol.** Flight Lieutenant Bhawana Kanth became the first woman pilot of the Indian Air Force to qualify to undertake combat missions on a fighter jet.

**S180. Ans.(b)**

**Sol.** Kerala based private sector lender, Federal Bank has tied up with MMTC Ltd. for distribution of Indian Gold Coins (IGC), the first-Ever national gold offering by the government, which was launched by Prime Minister Narendra Modi In November 2015.

**S181. Ans.(c)****S182. Ans.(b)**

**Sol.** National Payments Corporation of India (NPCI) will function as the authorized Bharat Bill Payment Central Unit (BBPCU), which will be responsible for setting business standards, rules and procedures for technical and business requirements for all the participants. NPCI, as the BBPCU, will also undertake clearing and settlement activities related to transactions routed through BBPS.

**S183. Ans.(e)**

**Sol.** An oligopoly is a market form wherein a market or industry is dominated by a small number of sellers (oligopolists).

**S184. Ans.(a)**

**Sol.** While hawala transactions in India are prohibited by the Foreign Exchange Management Act, 1999 (FEMA), which repeals the earlier Foreign Exchange Regulation Act, 1973, (FERA), there are other laws and regulations that also restrict such transactions.

**S185. Ans.(d)**

**Sol.** Bank of Maharashtra (BoM) has partnered with M1Xchange Trade Receivables Discounting System (TReDS) platform for MSME bill discounting. TReDS is a digital platform to support micro, small and medium enterprises (MSMEs) to get their bills financed at a competitive rate through an auction where multiple registered financiers can participate.

**S186. Ans.(c)**

**Sol.** The deduction on education can be claimed only when you start the repayment and is available up to eight years, or until the payment of interest in full, whichever is earlier. This means, if you repay the loan within, say, five years, you can claim deduction only till such period.

**S187. Ans.(a)**

**Sol.** The World Economic Outlook (WEO) database contains selected macroeconomic data series from the statistical appendix of the World Economic Outlook report, which presents the IMF staff's analysis and projections of economic developments at the global level, in major country groups and in many individual countries. The WEO is released in April and September/October each year

**S188. Ans.(c)**

**Sol.** Airtel Payments Bank has partnered with Bharti AXA Life Insurance to offer the Bharti AXA Life POS Saral Jeevan Bima Yojana through banking points across India.

**S189. Ans.(a)**

**Sol.** Article 110(3) of the Constitution of India categorically states that 'if any question arises whether a Bill is a Money Bill or not.

**S190. Ans.(c)**

**Sol.** NABARD is responsible for regulating and supervising the functions of Co-operative banks and RRBs. In this direction, the Institutional Development Department of NABARD has been taking several initiatives in association with the Government of India and RBI to improve the health of Co-operative banks and Regional Rural Banks.

**S191. Ans.(d)****S192. Ans.(d)**

**Sol.** Eminent theatre organizer and playwright Kartik Chandra Rath passed away in Odisha. He is the recipient of Kendra Sangeet Natak Akademi award and Odisha Sangeet Natak Akademi award.

**S193. Ans.(c)**

**Sol.** World Day for International Justice is also known as International Criminal Justice Day or International Justice Day. It is observed globally on 17 July every year to recognize the strengthening system of international justice.

**S194. Ans.(b)**

**Sol.** WHO Adopts Digital Health Resolution Initiated by India. Health and Family Welfare Minister JP Nadda said the resolution on digital health brought out by India was adopted by the 71st World Health Assembly, the decision-making body of the World Health Organization (WHO).

**S195. Ans.(c)**

**Sol.** Riyadh is the Capital of Saudi Arabia.

**S196. Ans.(b)**

**Sol.** Shuklaganj is a suburb of Kanpur, Uttar Pradesh, situated on the banks of holy river Ganges about 3 km from Kanpur and 15 km to Unnao.

**S197. Ans.(e)**

**Sol.** Maithon Dam is built on the river of Barakar located at Maithon and is a big dam in tribal state Jharkhand. Maithon Dam is one of the most popular dams in Jharkhand and one of the most successful multipurpose projects in India.

**S198. Ans.(d)**

**Sol.** Bardo Chham is a folk dance of Sherdukpens, a small community of West Kameng District of Arunachal Pradesh, Bardo Chham depicts the victory of good over evil.

**S199. Ans.(b)**

**Sol.** The 2980MW Sipat Super Thermal Power Plant located at Sipat in the Bilaspur district of Chhattisgarh, ranks as the fifth largest thermal power station in India. It is a coal-based power plant owned and operated by NTPC.

**S200. Ans.(a)**

**Sol.** Located 22 km from Srinagar, Dachigam National Park is the northernmost placed national park and is spread over 140 sq. km.

**General Awareness**

Based on GA POWER CAPSULE

**IBPS RRB MAINS**

 **bankersadda.com**

2000 + Questions  
Current Affairs | Banking | Static





adda247 publications

BOOKS

A grid of 48 book covers from Adda247 Publications, organized in 6 rows and 8 columns. The books cover various exam categories including SSC CGL, IBPS, Bank PO, and general aptitude. Key titles include 'The Cracker' for Geometry and Mensuration, '100 SSC CGL' for Tier-I/Prelims, '20+ SSC CGL Tier-II / Mains 2015-18', 'Ace SSC Arithmetic', 'Ace SSC Advanced Maths', 'Ace SSC General Intelligence & Reasoning', 'Ace SSC English Language & Comprehension Book', 'Ace SSC General Awareness', '1800+ Questions 15+ Insurance Exams', '2400+ Questions 25+ Bank PO & Clerk Prelims', '15+ Bank PO | Clerk Mains', 'The Cracker' for Bank Mains Exams, '20+ IBPS PO/CWE-VIII', '20+ IBPS PO Prelims 2018 Mock Paper', '20+ IBPS Clerk CWE-VIII', '50+ Bank PO & Clerk 2016-18', 'A Complete Book of Puzzle & Seating Arrangement', 'A Complete Book of Data Interpretation & Analysis', 'Ace IT Officer', 'Bank Exams Interviews', 'Ace Banking & Static Awareness', 'Ace Reasoning', 'Ace Quant', and 'Ace English'.

Visit: [publications.adda247.com](http://publications.adda247.com) & [store.adda247.com](http://store.adda247.com)  
For any information, mail us at [publications@adda247.com](mailto:publications@adda247.com)