

(1-5) SBI Clerk 30th July (1-5) (2019)
(6-10) IBPS PO 6th September (1-5) (2018)
(11-13) SBI PO 3rd May (11-13) (2018)
(14-15) SBI Clerk 25th May (14-15) (2018)

Paper-Maker Paper Maker 10

Directions (1-5): Study the following information carefully and answer the given questions.

Eight persons are sitting around a rectangular table some are facing centre while rest are facing outside the centre. Two persons sit on each side of the table. The persons sit on each side sit exact opposite to the persons who sit on other side of table, no person sits on the corner of the table. The ones who like Cities face centre while the one who like colour face outside.

D likes pink and sits second to the right of E, who does not like colour. C is not an immediate neighbour of E and doesn't sit opposite to E. The one who likes grey sits Second to the left of C. The one who likes grey is not an immediate neighbour of D. E doesn't like grey. C doesn't like colour. Immediate neighbours of C face same direction. B likes Pune and the one who likes Goa sits third to the right of B. A likes red and is not an immediate neighbour of D. No two persons can sit together according to alphabetical order (e.g. A can't sit with B and B can't sit with C and so on). Not more than two persons who sit together face same direction. B sits immediate left of D. **F does not like city.** The one who likes yellow sits second right of A. G likes blue. H sits third left of the one who likes Delhi. C and A does not sit on same side.

Q1. Which of the following likes by E?

- (a) Delhi
- (b) Grey
- (c) Yellow
- (d) Goa
- (e) None of these

L1Difficulty 2

QTags Puzzle

Q2. Who among the following sits second to the left of C?

- (a) D
- (b) F
- (c) G
- (d) A
- (e) None of these

L1Difficulty 2

QTags Puzzle

Q3. Who among the following sits second to the right of the one who likes pink colour?

- (a) The one who likes red
- (b) F
- (c) the one who likes Delhi

- (d) H
 - (e) None of these
- L1Difficulty 2
QTags Puzzle

- Q4. Who among the following sits opposite to the one who likes grey colour?
- (a) C
 - (b) D
 - (c) G
 - (d) A
 - (e) None of these
- L1Difficulty 2
QTags Puzzle

- Q5. Which of the following statement is true about B?
- (a) B faces outside
 - (b) B likes colour
 - (c) B sits third to the right of E
 - (d) H is an immediate neighbour of B
 - (e) None is true
- L1Difficulty 2
QTags Puzzle

Solution (1-5):
Sol.

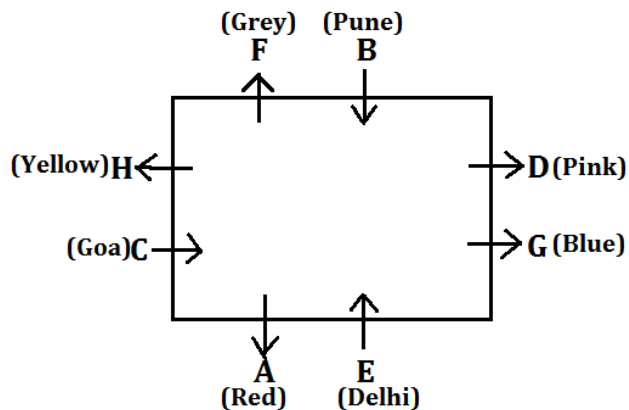

- S1. Ans.(a)
- S2. Ans.(b)
- S3. Ans.(c)
- S4. Ans.(d)
- S5. Ans.(c)

Directions (6-10): **Answer these questions based on the following information.**

In a certain code:

“Apple dire accrual trawling” is coded as - “@A6 #N7 #R3 @L4”

“Seems licks rudely” is coded as - “#M4 #K4 #L5”

“Straits April August Wrong” is coded as - “#T6 #N4 @I4 @S5”

Q6. What would be the code of ‘Answer’?

(a) #W6

(b) @N6

(c) #T6

(d) #R6

(e) @E5

L1Difficulty 2

QTags Coding-Decoding

Q7. The code ‘#Y7’ belongs to which of the following word?

(a) Bhartiya

(b) Given

(c) People

(d) person

(e) Belongs

L1Difficulty 2

QTags Coding-Decoding

Q8. According to the following pattern, what is the code of the word ‘straits’?

(a) #S6

(b) @S6

(c) @S5

(d) #T6

(e) None of these

L1Difficulty 2

QTags Coding-Decoding

Q9. What must be the code of ‘Government’ according to above information?

(a) #T9

(b) #N9

(c) @G10

(d) @N10

(e) None of these

L1Difficulty 2

QTags Coding-Decoding

Q10. What would be the code of ‘Purse’?

(a) #P4

(b) #E6

(c) @E5

(d) @R5

(e) #S4

L1Difficulty 2

QTags Coding-Decoding

S6. Ans.(e)

Sol. This coding decoding question is based on the new pattern. In this, question the words are coded as per following rules.

(i) First element of code is based on vowel starting word. If any word started with Vowel alphabet then symbol is used @, and for consonant starting word # is used.

(ii) 2nd code is 2nd last alphabet of a particular word.

(iii) 3rd code is total number of letter in a word -1.

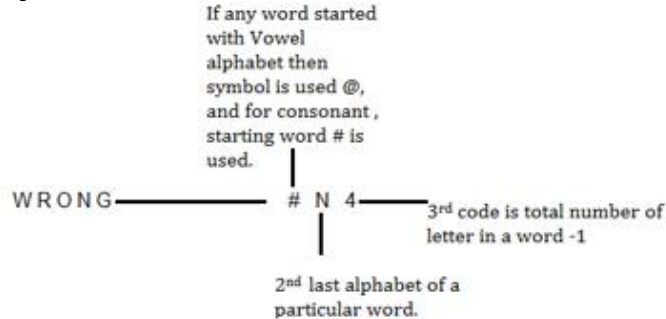

S7. Ans.(a)

Sol. This coding decoding question is based on the new pattern. In this, question the words are coded as per following rules.

(i) First element of code is based on vowel starting word. If any word started with Vowel alphabet then symbol is used @, and for consonant starting word # is used.

(ii) 2nd code is 2nd last alphabet of a particular word.

(iii) 3rd code is total number of letter in a word -1.

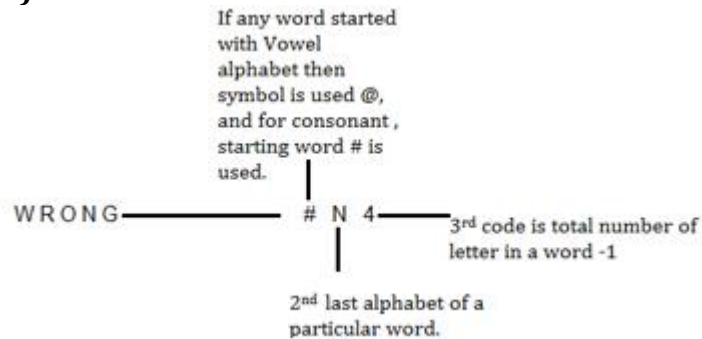

S8. Ans.(d)

Sol. This coding decoding question is based on the new pattern. In this, question the words are coded as per following rules.

(i) First element of code is based on vowel starting word. If any word started with Vowel alphabet then symbol is used @, and for consonant starting word # is used.

(ii) 2nd code is 2nd last alphabet of a particular word.

(iii) 3rd code is total number of letter in a word -1.

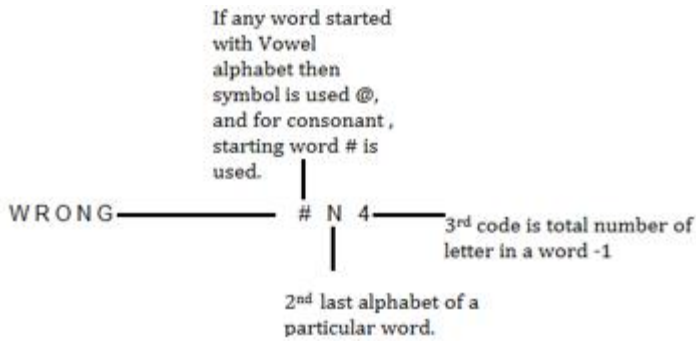

S9. Ans.(b)

Sol. This coding decoding question is based on the new pattern. In this, question the words are coded as per following rules.

(i) First element of code is based on vowel starting word. If any word started with Vowel alphabet then symbol is used @, and for consonant starting word # is used.

(ii) 2nd code is 2nd last alphabet of a particular word.

(iii) 3rd code is total number of letter in a word -1.

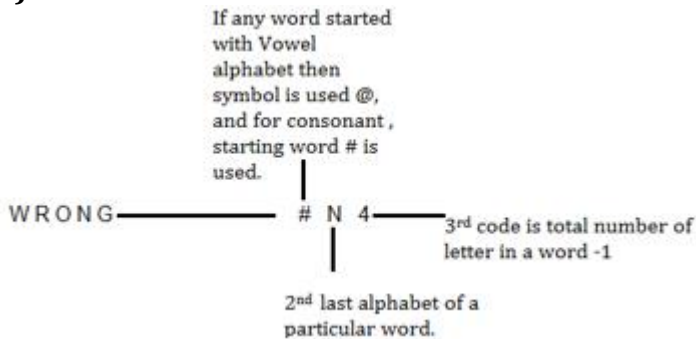

S10. Ans.(e)

Sol. This coding decoding question is based on the new pattern. In this, question the words are coded as per following rules.

(i) First element of code is based on vowel starting word. If any word started with Vowel alphabet then symbol is used @, and for consonant starting word # is used.

(ii) 2nd code is 2nd last alphabet of a particular word.

(iii) 3rd code is total number of letter in a word -1.

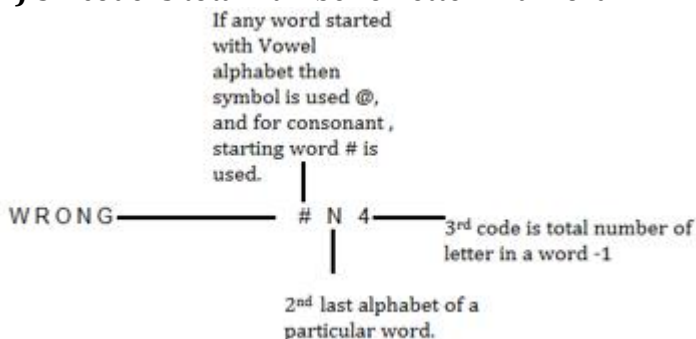

Directions (11-13): **Study the following information carefully and answer the questions given below.**

One morning Love and Kush start their journey from the same point in the opposite direction. Love walks for 6km and then take a right turn and walk for 4km then he again takes a left turn to walk 4km towards east and stopped at this point. While Kush walk for 5km and take a right turn then after walking 3km he takes a right turn and again walk for 2km. He then turned left and walked 1km and stopped at this point.

Q11. In which direction Kush finally faces?

- (a) North
- (b) south
- (c) East
- (d) West
- (e) Cannot be determined

L1Difficulty 2

QTags Reasoning

Q12. What is the shortest distance between Kush's final position and Love's final position?

- (a) $\sqrt{181}$ m
- (b) 19m
- (c) 25m
- (d) $\sqrt{164}$ m
- (e) None of these

L1Difficulty 2

QTags Reasoning

Q13. **What is the direction of Kush's final point with respect to Love's final point?**

- (a) North
- (b) South
- (c) North-west
- (d) North-east
- (e) South-west

L1Difficulty 2

QTags Reasoning

S11.Ans(a)

Sol.

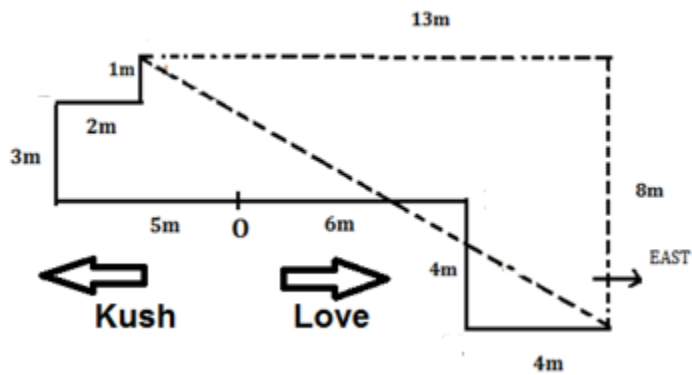

S12.Ans(e)

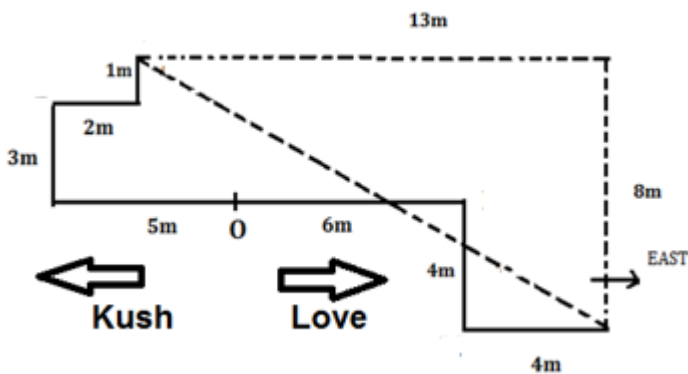

Sol.

S13.Ans(c)

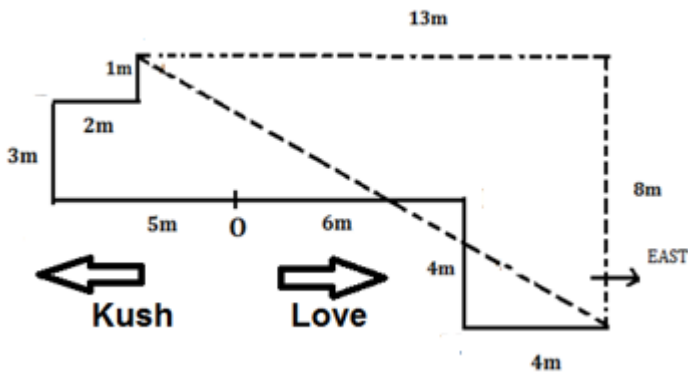

Sol.

Directions (14-15): **Study the given information and answer the following question.**

A person starts walking in north direction from point X, after walking 5m he reached at point A, then he takes left turn and walks some distance to reach at point Y. After that he walks in north-east direction and walks 13m to reach at point M. Point N is 5m west of point Y. Distance between point M and Y is same as the distance between Point Y and X. **Point X is south of M.**

Q14. What is the shortest distance between point A and point N?

(a) 25m

- (b) 15m
- (c) 20m
- (d) 17m
- (e) None of these

L1Difficulty 2

QTags Reasoning

Q15. What is the direction of point M with respect to N?

- (a) North-east
- (b) North
- (c) South-west
- (d) South-east
- (e) None of these

L1Difficulty 2

QTags Reasoning

S14. Ans.(d)

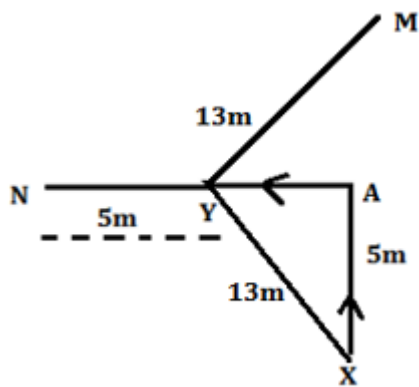

Sol.

$$YX=13m$$

$$AY^2 = YX^2 - AX^2$$

$$AY^2 = (169-25)$$

$$AY^2 = 144$$

$$\text{Hence, } AY=12m$$

$$AN= NY+YA$$

$$= (5+12)$$

$$AN=17m$$

S15. Ans.(a)

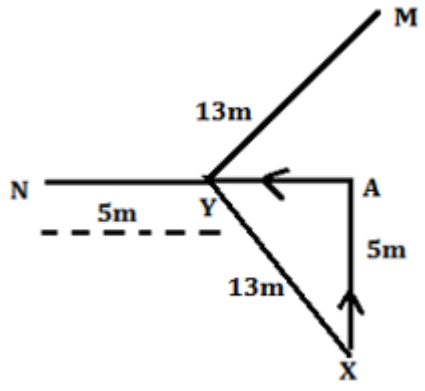

Sol.