

Quiz Date: 28th April 2020

Directions (1-5): **Study the following information carefully and answer the questions given below.**

Eight People viz. P, Q, R, S, W, X, Y and Z are sitting around a Square table in such a way that four of them sit at the corners of the square and rest are sit in the middle of the sides of the square but not necessarily in the same order. Some of them are facing towards the center while some are facing away from the center of the table. No any two immediate neighbour faces the same direction. Each person like different games i.e. Rugby, Ludo, Cricket, Football, Volleyball, Lawn-Tennis, Table-Tennis and Chess but not necessarily in the same order.

X who likes Table-Tennis sits on the corner of the table. P sits second to the left of Z who is not an immediate neighbour of Y and X. W neither likes Volleyball nor Football. X and Y sits to the immediate right and third to the right of W respectively. The person who likes the Rugby game sits to the immediate left of the person who likes the Ludo. The one who likes Ludo sits opposite of W. R likes Chess and sits third to the right of S. Two person sit between the one who like the chess and Q. W is not immediate neighbour of P. R sits opposite to the one who likes Football. W likes Lawn-Tennis and sits third to the left of the one who likes Cricket. W does not face towards P.

Q1. Who sit second to the right of the one who like the Volleyball game?

- (a) The one who like the Football game
- (b) R
- (c) S
- (d) The one who like the Ludo game
- (e) X

Q2. How many people sit between the one who like the Ludo and the one who like the Table-Tennis (when counted anticlockwise from the one who like Ludo).

- (a) one
- (b) Three
- (c) Four
- (d) Five
- (e) None of these

Q3. Four of the following are like in a certain way and hence form a group. Which is the one that does not belong to that group?

- (a) Z
- (b) The one who like the Rugby
- (c) W
- (d) The one who like the Ludo
- (e) R

Q4. Which of the following is true regarding Q?

- (a) Q does not sit at the corner of the table
- (b) The person who like the Chess sit opposite to Q

- (c) S sits second to the left of Q
- (d) Z is not an immediate neighbour of Q.
- (e) None of the given options are true.

Q5. Who sit opposite to Y?

- (a) Q
- (b) the one who like the Chess
- (c) S
- (d) the one who like the Volleyball
- (e) Both (a) and (d)

Directions (6-10): **Study the information and answer the following questions:**

In a certain code language

"party said this might" is coded as " B#6 H@5 G@5 G#6 "

"bill has been passed" is coded as " O@5 H#4 M@5 H@7 "

"more and six girl" is coded as " I@5 M#4 C#4 I@5 "

Q6. What is the code for 'supported'?

- (a) G#10
- (b) H#10
- (c) G#1
- (d) G#11
- (e) None of these

Q7. What is the code for 'asking'?

- (a) H@17
- (b) K@7
- (c) H#7
- (d) H@7
- (e) None of these

Q8. What is the code for 'select'?

- (a) G@17
- (b) L@7
- (c) G@7
- (d) G#7
- (e) None of these

Q9. What is the code for 'certain'?

- (a) G#18
- (b) G@8
- (c) H#8
- (d) G#8
- (e) None of these

Q10. What is the code for 'remain'?



- (a) I#7
- (b) I@7
- (c) I@17
- (d) H@7
- (e) None of these

Directions (11-12): **Study the following information and answer the questions given below:**

There are eight family members i.e A, B, C, D, E, F, G and H. B is the brother of C who is mother of E. F is the sister of E. E is married to A. A is sister in law of F. F married to H who is son of D. A is daughter of G.

Q11. How is E related to G?

- (a) Son
- (b) Daughter
- (c) Son in law
- (d) Daughter in law
- (e) None of these

Q12. How is F related to B?

- (a) Son
- (b) Daughter
- (c) Niece
- (d) Nephew
- (e) Son in law

Direction (13-15): **In the following questions, the symbols #, &, @, *, \$, % and © are used with the following meanings as illustrated below. Study the following information and answer the given questions:**

- P@Q- P is the child of Q
- P©Q- P is the parent of Q
- P%Q- P is father-in-law of Q
- P&Q- P is brother-in-law of Q
- P\$Q- P is brother of Q
- P*Q- P is wife of Q

Q13. If 'K©M\$O@S, K%R*O' is true, how R is related to S?

- (a) Daughter
- (b) Brother
- (c) Daughter-in-law
- (d) Sister
- (e) None of these

Q14. If 'E%G©K@D&F\$U' is true, how K is related to U?

- (a) Niece
- (b) Brother

- (c) Nephew
 (d) Son
 (e) Either (a) or (c)

Q15. If '\$R*T@M\$V' is true, how S is related to V?

- (a) Father
 (b) Grand father
 (c) Aunt
 (d) Uncle
 (e) None of these

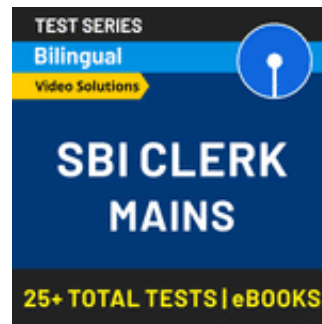

BANKERS
 Solution

Solution (1-5)

Sol.

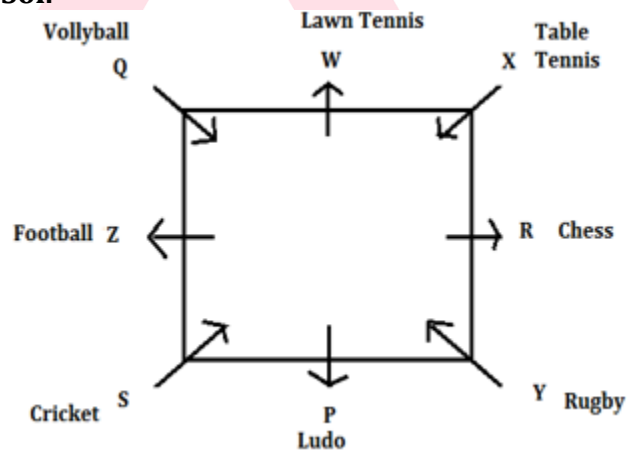

- S1. Ans(c)
 S2. Ans(e)
 S3. Ans(b)
 S4. Ans(e)
 S5. Ans(e)

Solution (6-10):

Sol. These are the latest pattern of coding-decoding questions. In these questions we are applying following concept: -

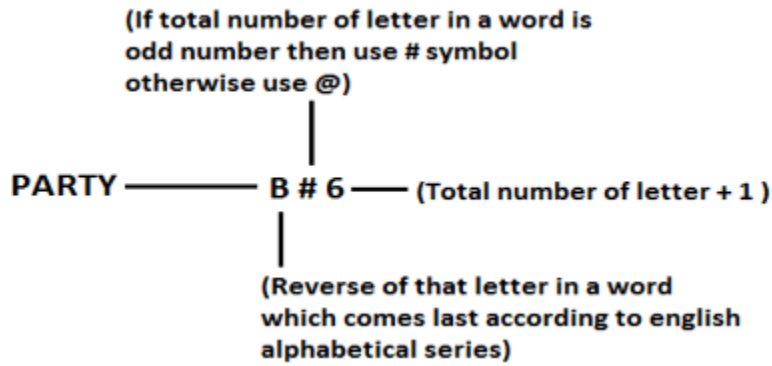

- S6. Ans.(e)
- S7. Ans.(d)
- S8. Ans.(c)
- S9. Ans.(d)
- S10. Ans.(b)

Solutions (11-12):

Sol.

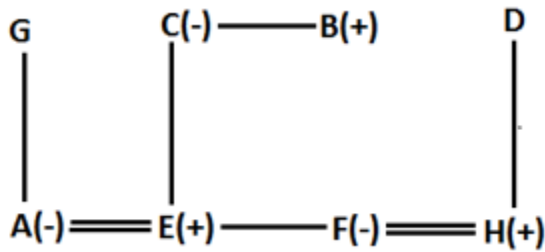

- S11. Ans.(c)
- S12. Ans.(c)

Solutions (13-15):

S13. Ans.(c)

Sol.

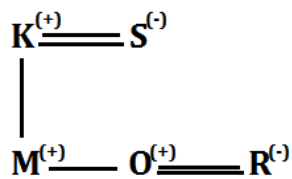

S14. Ans.(e)

Sol.

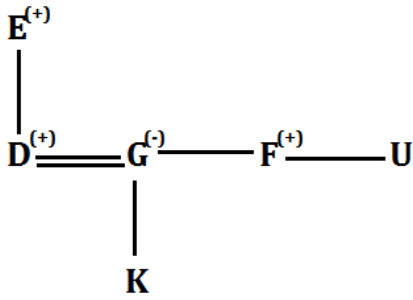

S15. Ans.(d)

Sol.

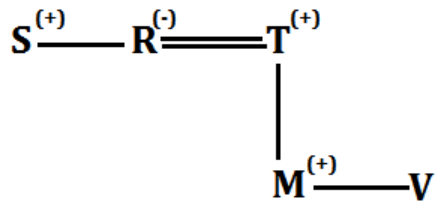

BILINGUAL

SBI CLERK MAINS
COMPLETE BATCH

Starts March 20, 2020

2 PM to 6 PM



For any Banking/Insurance exam Assistance, Give a Missed call @ 01141183264