

500 Most Important Questions for SBI Clerk Prelims | REASONING

Directions (1-5): Study the following arrangement carefully and answer the questions given below.

@ E K 4 F 7 B 5 R 1 © D A M 6 U J \$ V Q # 2 P 3 % 9 H I W 8 *

Q1. Which of the following element is exactly in the middle of first vowel in this series from the left side and 5 in the above arrangement?

- (a) 7
- (b) F
- (c) R
- (d) 4
- (e) None of these

Q2. How many such symbols are there in the above arrangement each of which is immediately preceded by a consonant but not immediately followed by a Vowel?

- (a) None
- (b) One
- (c) Two
- (d) Three
- (e) More than three

Q3. Four of the following five are alike in a certain way based on their position in the above arrangement and so form a group. Which is the one that does not belong to that group?

- (a) FB7
- (b) 23P
- (c) 9IH
- (d) V2#
- (e) 1D©

Q4. How many such symbols are there in the above arrangement each of which is immediately preceded by a number but not immediately followed by a consonant?

- (a) None
- (b) One
- (c) Two
- (d) Three
- (e) More than three

Q5. How many such Vowel is there in the above arrangement each of which is immediately followed by a number but not immediately preceded by a symbol?

- (a) None
- (b) One
- (c) Two
- (d) Three
- (e) More than three

Directions (6-10): Study the following series and answer the questions referring to the word sequence given below:

YOM MJK UGJ IMX KQZ

Q6. If words are arranged according to the alphabetical series from left to right, then which word is third from the left end?

- (a) UGJ
- (b) IMX
- (c) KQZ
- (d) MJK
- (e) None of these

Q7. If each letter in each of the word is arranged according to the alphabetical series, then which is the 2nd letter of the word, which is fourth from the left end?

- (a) Y
- (b) X
- (c) M
- (d) I
- (e) None of these

Q8. If each vowel of each word is changed to its next letter according to the alphabetical series, then How many meaningful words will be formed?

- (a) Two
- (b) None
- (c) One
- (d) Three
- (e) None of these

Q9. If each consonant of each word is changed to its previous letter according to the alphabetical series, then How many words will be there which contains at least one vowels?

- (a) Two
- (b) None
- (c) Three
- (d) Four
- (e) None of these

Q10. If first and second letter of each word are interchanged with each other, then how many meaning words will be formed?

- (a) Two
- (b) None
- (c) One
- (d) Three
- (e) None of these

Directions (11-15): Study the following arrangement carefully and answer the questions given below.

387 876 176 285 721 937

Q11. In each number, when we added 1 to each odd digit and 2 is subtracted from each even digit, then which number will be lowest?

- (a) 387
- (b) 876
- (c) 176
- (d) 285
- (e) None of these

Q12. If all the digits of each number are arranged in ascending order within the number, then which number among them will be third highest?

- (a) 387
- (b) 937
- (c) 176
- (d) 285
- (e) None of these

Q13. If the first two digits of each number are interchanged, which among these numbers will be the highest number?

- (a) 721
- (b) 876
- (c) 937
- (d) 387
- (e) None of these

Q14. In each number, if we subtract 1 from the first digit, then which among these numbers will be the highest?
Q15. In each number, if we added first and 2nd digit and after addition, subtracted 3rd digit, then the resultant of how many numbers will be more than 5?

- (a) None
- (b) One
- (c) Two
- (d) Three
- (e) None of these

Directions (16-20): Study the following arrangement carefully and answer the questions given below.

V 4 Y % I 3 Z 6 # U S @ R 2 W 9 © P F \$ D 1 N K 5 * J 8 G

Q16. How many such numbers are there in the above arrangement, each of which is immediately preceded by a symbol and immediately followed by also a symbol?

- (a) None
- (b) One
- (c) Two
- (d) Three
- (e) More than three

Q17. How many symbols are there in above arrangement which is immediately followed by number?
 (a) Three
 (b) More than three
 (c) Two
 (d) One
 (e) None

Q18. Which of the following element is the fourth to the right of the one which is sixth from the left end of the above arrangement?
 (a) ©
 (b) R
 (c) Z
 (d) N
 (e) None of these

Q19. Which of the following element is the six to the left of the one which is eleventh from the left end of the above arrangement?
 (a) 2
 (b) W
 (c) 9
 (d) N
 (e) I

Q20. If all the symbols are dropped from the above series then which of the following element is ninth from right end?
 (a) F
 (b) P
 (c) 9
 (d) W
 (e) 2

Directions (21-25): Study the following sequence and answer the given questions.

H J @ 1 I V \$ 5 S 6 K 9 % O # E ! A Z 2 © B ® 8 7 F N M 3 Q 4 & R

Q21. Which of the following element is 9th to the left of the one which is 23rd from the left end of the given arrangement?
 (a) &
 (b) O
 (c) #
 (d) %
 (e) None of these

Q22. How many such digits are there in the given series each of which is immediately preceded by a symbol but not immediately followed by an alphabet?

- (a) One
- (b) Two
- (c) Three
- (d) Four
- (e) None

Q23. How many such symbols are there in the given series which are immediately preceded by an alphabet but not immediately followed by a number?

- (a) One
- (b) Two
- (c) Three
- (d) Four
- (e) None

Q24. How many such elements are there in the given series which are immediately preceded by a number and followed by a consonant?

- (a) One
- (b) Two
- (c) Three
- (d) Four
- (e) More than four

Q25. What should come in place of question mark (?) in the following series based on the above arrangement?

&3R N8M BZ® !OA ?

- (a) 96%
- (b) 95%
- (c) %60
- (d) 95%
- (e) None of these

Directions (26-30): Study the following sequence and answer the given questions.

Z X # 8 D F 9 \$ 1 K M & 7 5 E O % I V @ 2 4 H G # B R P 6 \$

Q26. How many such Symbols are there in the given series which are immediately preceded by consonant but not immediately followed by consonant?

- (a) One
- (b) Three
- (c) Four
- (d) Five
- (e) None of these

Q27. Which of the following element is 19th to the right of the one which is 26th from the right end of the given arrangement?

- (a) H
- (b) G
- (c) #
- (d) B
- (e) None of these

Q28. If all the symbols are dropped from the series, which element will be fourth to the right of the one which is sixteenth from the right end of the new arrangement?

- (a) D
- (b) F
- (c) E
- (d) 5
- (e) None of these

Q29. How many such numbers are there in the given series which are immediately preceded or followed by a consonant?

- (a) One
- (b) Two
- (c) Three
- (d) Four
- (e) None of these

Q30. What should come in place of question mark (?) in the following series based on the above arrangement?

XD# 9K\$ &E7 %@I ?

- (a) HBG
- (b) 2G4
- (c) 4GH
- (d) 4#H
- (e) 4#G

Directions (31-35): Study the information carefully and answer the questions given below.

There are eight boxes J, K, L, M, N, O, P and Q are placed one above another. Two boxes are placed between Box K and Box N. Box Q is placed immediately below Box N. One box is placed between Box P and Box L. Box M is placed one of the above place of N and one of the below place of Box O but not immediate above or below. Box J and Box O is not placed above Box P.

Q31. Which of the following box is placed just below box L?

- (a) N
- (b) Q
- (c) M
- (d) O
- (e) None of these

Q32. Which of the following box is placed just above box N?

- (a) Q
- (b) L
- (c) M
- (d) J
- (e) None of these

Q33. How many boxes are placed between box O and box N?

- (a) Three
- (b) Two
- (c) One
- (d) Four
- (e) None

Q34. What is the position of box M?

- (a) Third from the top
- (b) Second from the top
- (c) Third from the bottom
- (d) Second from the bottom
- (e) None of these

Q35. Four of the following five are alike in certain way based from a group, find the one that does not belong to that group?

- (a) P-L
- (b) O-K
- (c) N-M
- (d) L-N
- (e) Q-J

Directions (36-40): Study the information carefully and answer the questions given below.

Nine persons are living in a nine-floored building. Ground floor is numbered as 1 and top floor is numbered as 9. Four persons are living between R and V, who lives below R. X lives on an odd numbered floor below R's floor. More than three persons live between X and P. S lives on an even numbered floor. Neither P nor V lives on an even numbered floor. Three persons are live between T and S. T lives one of the floors below X's floor. W lives below U but above Q. Not more than two floors between U and S's floor.

Q36. Who among the following lives on 6th floor?

- (a) T
- (b) Q
- (c) S
- (d) U
- (e) None of these

Q37. Who among the following lives just below Q's floor?

- (a) S
- (b) V
- (c) X
- (d) P
- (e) None of these

Q38. Which of the following statement is true about W?

- (a) W lives on an even numbered floor
- (b) Only two persons live between W and V
- (c) S lives just below W
- (d) More than two floors between U and W
- (e) None is true

Q39. How many persons live between T and X?

- (a) Two
- (b) Three
- (c) Four
- (d) More than Four
- (e) None

Q40. Q lives on which of the following floor?

- (a) 7th floor
- (b) 8th floor
- (c) 5th floor
- (d) 2nd floor
- (e) None of these

Q41. If it is possible to make only one meaningful word with the 3rd, 6th, 8th and 10th letters of the word 'COMPLIMENT', which would be the third letter of the word from the left? If more than one such word can be formed give 'Y' as the answer. If no such word can be formed, give 'Z' as your answer.

- (a) Y
- (b) T
- (c) I
- (d) E
- (e) Z

Q42. If in the number 546839271, 1 is added to first, third, fifth, seventh and ninth digit and 1 is subtracted from the second, fourth, sixth and eighth digits, then all digits are arranged in descending order from left to right. Which of the following digit is 4th from the right end?

- (a) 7
- (b) 6
- (c) 3
- (d) 4
- (e) None of these

Directions (43-45): Study the information carefully and answer the questions given below.

Eight students P, Q, R, S, T, U, V and W, appear in an examination in two different shifts either at 10 AM or 3 PM. They give exam on different months of the same year starting from March to June. Only two persons give exam in between W and T, whose exam is in the month which have even number of days. P gives exam in the month having 31 days. S gives exam in evening shift but before W. Three persons give exam between U and R. W gives exam before T. V gives an exam in evening shift of the month which have odd number of days but after W. U gives the exam in the month having 30 days but not in June. Only two persons give exam between P and Q.

Q43. How many persons give their exam between S and R?

- (a) One
- (b) Two
- (c) Three
- (d) Four
- (e) None

Q44. Q gives exam in which of the following month?

- (a) March
- (b) April
- (c) May
- (d) June
- (e) Can't determined

Q45. Which of the following is true about W?

- (a) June- 3PM
- (b) March-10AM
- (c) May-10AM
- (d) April-3PM
- (e) None is true

Directions (46-50): Study the information carefully and answer the questions given below.

Eight persons are sitting around a square table in such a way four persons are sitting at four corners and facing outside while other four persons are sitting middle of each side and facing inside. Q sits third to the right of R. T sits third to the left of one of the immediate neighbours of Q. S sits second to the right of the one who sits second to the right of T. P neither immediate neighbour of R nor Q. V sits third to the right of U, who does not sits at any corners. W sits second to the left of V.

Q46. Who among the following sits opposite to W?

- (a) S
- (b) R
- (c) V
- (d) T
- (e) None of these

Q47. Who among the following sits second to the left of the one who sits third to the right of P?

- (a) V
- (b) W
- (c) Q
- (d) R
- (e) None of these

Q48. Which of the following statement is true about V?

- (a) V sits second to the right of P
- (b) U sits opposite to V
- (c) R sits third to the left of V
- (d) V sits immediate right of the one who sits second to the right of U
- (e) None is true

Q49. What is the position of S with respect to Q?

- (a) Fourth to the right
- (b) Second to the left
- (c) Third to the right
- (d) Immediate left
- (e) None of these

Q50. Who among the following sits third to the left of V?

- (a) S
- (b) U
- (c) R
- (d) T
- (e) None of these

Directions (51-55): Study the information carefully and answer the questions given below.

Seven employees A, B, C, D, E, F and G of a bank are working on seven different designations viz. CEO, GM, DGM, AGM, Manager, Junior Manager and Clerk. All the designations given are to be considered in a given order (as CEO is considered as Senior-most and Clerk is considered as the Junior-most).

Not more than two persons are junior to E. Two designations lie between E and B. A is senior to D. C is not CEO. C is Senior to F. More than two persons are senior to A. D is not clerk. C is not GM.

Q51. Who among the following person is AGM?

- (a) B
- (b) C
- (c) F
- (d) D
- (e) None of these

Q52. Who among the following is GM?

- (a) C
- (b) G
- (c) B
- (d) D
- (e) E

Q53. How many designations lie between G and D?

- (a) Three
- (b) Five
- (c) None
- (d) Four
- (e) More than Five

Q54. Who among the following is CEO?

- (a) G
- (b) C
- (c) A
- (d) D
- (e) None of these

Q55. Which of the following statement is true regarding F?

- (a) F is senior to only one person
- (b) D is just junior to F
- (c) F is clerk
- (d) F is junior to only three persons
- (e) None is true

Directions (56-60): Study the information carefully and answer the questions given below.

Eight persons K, L, M, N, O, P, Q and R are sitting around a circular table. Some of them face inside and some of them face outside. All information is not necessarily in same order.

Two persons sit between L and R. L sits opposite to P and both of them face towards center. O sits immediate left of K. M sits immediate left of R. Q sits second to the right of N. N sits third to the left of M. Q doesn't sit opposite to the person who sits immediate right of L. One person sits between O and P. K faces same direction as O and Q. P is not immediate neighbor of O. Immediate neighbor of K face opposite direction to each other.

Q56. Which of the following sits third to left of Q?

- (a) P
- (b) K
- (c) O
- (d) N
- (e) None of these

Q57. Who among the following sits third to the right of L?

- (a) Q
- (b) O
- (c) R
- (d) M
- (e) None of these

Q58. How many persons sit between M and K when counted from left of K?

- (a) Four
- (b) Two
- (c) More than four
- (d) Three
- (e) None

Q59. Who among the following sits second to the right of O?

- (a) The one who sits immediate left of N
- (b) M
- (c) R
- (d) The one who sits second to right of M
- (e) None of these

Q60. Four of the following five are alike in certain way based from a group, find the one that does not belong to that group?

- (a) R
- (b) P
- (c) L
- (d) O
- (e) M

Directions (61-65): Study the information and answer the following questions:

In a certain code language

'book latest page quiz' is written as ' sx vt fa ba',

'study online book road' is written as ' fa lm mp qa ',

'online practice page update' is written as ' ca mp za vt',

'latest road quiz officer' is written as ' ba ta lm sx',

Q61. What is the possible code for 'road practice fraud' in the given code language?

- (a) ca lm za
- (b) lm za ta
- (c) ca ba lm
- (d) lm ty sx
- (e) lm ca yt

Q62. What is the code for 'page' in the given code language?

- (a) sx
- (b) vt
- (c) fa
- (d) ba
- (e) None of these

Q63. What is the code for 'online' in the given code language?

- (a) fa
- (b) lm
- (c) mp
- (d) qa
- (e) None of these

Q64. What is the possible code for 'update latest' in the given code language?

- (a) ca za
- (b) ca sx
- (c) za lm
- (d) sx ba
- (e) ca lm

Q65. What is the code for 'study' in the given code language?

- (a) fa
- (b) lm
- (c) mp
- (d) qa
- (e) None of these

Direction (66-70): Study the following information to answer the given questions:

In a certain code language

'global budget fear' is written as 'la ac df',

'global month table product' is written as 'pr rs ac tp',

'central budget month table survey' is written as 'tp df rs ge hg'

'sale month product' is written as 'rt tp pr'.

Q66. What is the code for 'product'?

- (a) oq
- (b) rs
- (c) pr
- (d) ac
- (e) tp

Q67. 'sale table month domestics' could be coded as?

- (a) tp rt rs oq
- (b) rt ac rs ge
- (c) df rt rs oq
- (d) rt ac pr oq
- (e) None of these

Q68. 'hg' stands for?

- (a) budget
- (b) month
- (c) survey
- (d) central
- (e) Either 'central' or 'survey'

Q69. Which of the following may be the code for 'keep month fear'?

- (a) tp la rt
- (b) la df oq
- (c) lb la tp
- (d) ge la ac
- (e) None of these

Q70. 'tp oq pr' is the code for ?

- (a) table month product
- (b) sale month product
- (c) month domestic product
- (d) Can't be determined
- (e) None of these

Directions (71-75): Study the following information to answer the given questions

In a certain code

'wealth secure movie create' is written as 'lp pk ks st',

'rural secure movie money' is written as 'ir ks fu lp'.

'create coin rural economy' is written as 'gt ir gb pk'

'movie replace coin happy' is written as 'gt xz lo ks'

Q71. What is the code for 'replace'?

- (a) gt
- (b) xz
- (c) lo
- (d) ks
- (e) Cannot be determined

Q72. Which of the following may represent 'money is secure'?

- (a) fu lp st
- (b) fu py lo
- (c) re lp gt
- (d) fu xz re
- (e) lp re fu

Q73. 'pk' is the code for

- (a) movie
- (b) create
- (c) secure
- (d) coin
- (e) Cannot be determined

Q74. What is the code for 'wealth'?

- (a) lp
- (b) pk
- (c) st
- (d) ks
- (e) Cannot be determined

Q75. Which of the following represents 'coin rural secure'?

- (a) ir gt lp
- (b) ni gt st
- (c) ir gt lo
- (d) pk ir gt
- (e) gt pk lp

Directions (76-80): Study the following information carefully and answer the given questions.

In a certain code language,

'special winner certifies health' is coded as 'zq ie mn as'

'care zone winner certifies' is coded as 'mn bn st ie'

'care court certifies health' is coded as 'cd as mn bn'

'special health liberty result' is coded as 'zq as zx yx'

Q76. Which of the following is the code for 'zone'?

- (a) st
- (b) bn
- (c) ie
- (d) mn
- (e) None of these

Q77. Which of the following word is coded as 'bn'?

- (a) court
- (b) health
- (c) zone
- (d) Care
- (e) None of these

Q78. What may be the code of 'court orange'?

- (a) st ie
- (b) cd mn
- (c) ie bn
- (d) mn ie
- (e) cd qw

Q79. Which of the following code is coded for 'Winner'?

- (a) mn
- (b) ie
- (c) bn
- (d) cd
- (e) None of these

Q80. What will be the code of 'result'?

- (a) zx
- (b) as
- (c) yx
- (d) Either (a) or (c)
- (e) None of these

Directions (81-85): Study the following information carefully and answer the questions given below:

In a certain code language:

'epic family black stone' is written as 'xl sa zh hx',

'Value code award watch' is written as 'ha fa dx da',

'stone watch family Value' is written as 'sa dx xl da' and

'epic stone award Value' is written as 'xl fa hx da'.

Q81. What is the code for 'stone watch' in the given code language?

- (a) xl fa
- (b) xl dx
- (c) da fa
- (d) dx da
- (e) None of these

Q82. What is the code for 'code' in the given code language?

- (a) ha
- (b) fa
- (c) dx
- (d) da
- (e) None of these

Q83. What is the code for 'watch' in the given code language?

- (a) ha
- (b) fa
- (c) dx
- (d) da
- (e) None of these

Q84. What is the code for 'Value watch' in the given code language?

- (a) ha da
- (b) fa dx
- (c) dx da
- (d) da fa
- (e) None of these

Q85. What is the code for 'family epic' in the given code language?

- (a) ha sa
- (b) fa hx
- (c) dx sa
- (d) sa hx
- (e) None of these

Directions (86-90): Study the following information carefully and answer the given questions.

In a certain code language,

'Year space appeal reason' is coded as 'mx fe fm xp'

'Space Climate society appeal' is coded as 'fm xp xe kx'

'Year appeal fashion Climate' is coded as 'xi xe fm fe'

'Yoga reason appeal preview' is coded as 'yh mx yz fm'

Q86. Which of the following is the code for 'appeal'?

- (a) mx
- (b) xe
- (c) fe
- (d) fm
- (e) None of these

Q87. Which of the following word is coded as 'xp'?

- (a) great
- (b) Year
- (c) space
- (d) appeal
- (e) None of these

Q88. What may be the code of 'word Year'?

- (a) fe fm
- (b) fe kx
- (c) fe xi
- (d) fe zx
- (e) None of these

Q89. Which of the following code is coded for 'Climate'?

- (a) fe
- (b) xe
- (c) xp
- (d) xi
- (e) None of these

Q90. What will be the code of 'yoga'?

- (a) yh
- (b) xi
- (c) yz
- (d) Either (a) or (c)
- (e) None of these

Direction (91-95): Study the following information to answer the given questions:

In a certain code language

'fact case under europe' is coded as 'la pa zi ta'

'winner case under fact' is coded as 'pa zi la sa'

'verdict under north roar' is coded as 'na hi ga pa'

'fact sport orange verdict' is coded as 'zi mi jo ga'

Q91. How will 'fact winner verdict' be coded in the given language?

- (a) zi la sa
- (b) zi sa ga
- (c) sa mi jo
- (d) pa zi mi
- (e) None of these

Q92. How will 'verdict under roar' be coded in the given language?

- (a) zi la sa
- (b) zi sa ga
- (c) sa mi jo
- (d) pa zi mi
- (e) None of these

Q93. What does 'pa' stand for?

- (a) winner
- (b) verdict
- (c) under
- (d) sport
- (e) None of the these

Q94. Which of the following will be coded as 'na hi la' in the given language?

- (a) case under roar
- (b) north roar case
- (c) winner case verdict
- (d) north fact verdict
- (e) None of these

Q95. What is the code for 'la' stand for?

- (a) case
- (b) verdict
- (c) winner
- (d) roar
- (e) None of these.

Directions (96-100): Study the information and answer the following questions:

In a certain code language,

'Fate red mobile peace' is coded as 'ka la ho ga',

'prepare and honour Fate' is coded as 'mo ta pa ka',

'peace values hero prepare' is coded as 'zi la ne mo' and

'prepare values honour Fate' is coded as 'zi mo ka ta'.

Q96. What is the code for 'prepare' in the given code language?

- (a) mo
- (b) ta
- (c) pa
- (d) ka
- (e) None of these

Q97. What is the code for 'peace' in the given code language?

- (a) ta
- (b) mo
- (c) Either pa or mo
- (d) la
- (e) Either mo or ta

Q98. What is the code for 'Fate' in the given code language?

- (a) ta
- (b) ka
- (c) either ta or ka
- (d) zi
- (e) mo

Q99. What may be the possible code for 'Black red mobile' in the given code language?

- (a) ki ho ga
- (b) mo ho ga
- (c) ki ho mo
- (d) ga zi ki
- (e) xi ka ta

Q100. What may be the code for 'values peace' in the given code language?

- (a) la ne
- (b) ga la
- (c) zi ka
- (d) zi ki
- (e) la zi

Directions (101-105): Study the information carefully and answer the questions given below.

Seven boxes are placed one above other, but not necessarily in the same order. Each of them is containing different food items.

Box E does not contain Chocolate. Box K is not placed above box F. Box which contains Burger is placed immediately below box E. There are two boxes placed between box F and the box which contains Burger. Box F is not placed above the box which contains Burger. Box which contains Momos is placed below box F. Three boxes are placed between box L and the box which contains Momos. The box which contains Samosa is placed immediately below box L. The box which contains Biscuit is placed immediately below box G. Only one box is placed between box K and box O. Neither box K nor box E contains Pastry. Box O does not contain Biscuit. Box G contains neither Pastry nor Chips. Box which contains Chocolate is not placed at the top. Box H does not contain Chocolate.

Q101. Which of the following box placed just below the box which contains Chips?

- (a) O
- (b) G
- (c) F
- (d) K
- (e) None of these

Q102. How many boxes are placed between G and H?

- (a) Two
- (b) Four
- (c) Three
- (d) More than four
- (e) None

Q103. Which of the following box contains Samosa?

- (a) G
- (b) F
- (c) K
- (d) O
- (e) None of these

Q104. Which of the following box placed just below the box which contains Pastry?

- (a) the box which contains Momos
- (b) L
- (c) the box which contains chocolate
- (d) F
- (e) None of these

Q105. Which of the following box contains Momos?

- (a) L
- (b) H
- (c) F
- (d) G
- (e) None of these

Directions (106-110): Study the information carefully and answer the questions given below.

Seven persons J, K, L, M, N, O and P buy seven different Mobile i.e. Samsung, Apple, Vivo, Oppo, Mi, Oneplus and Nokia. Each of them belongs to seven different places i.e. Gurgaon, Noida, Delhi, Agra, Jaipur, Rewari and Surat. All information is not necessarily in same order.

M belongs to Jaipur and buys Nokia. J belongs to Agra and does not buy Mi and Samsung. The one who buys Samsung belongs to Rewari. The one who belongs to Agra does not buy Oppo and Oneplus. P belongs to Delhi and does not buy Mi and Oppo. O buys Apple and does not belong to Noida. K does not buy Samsung and Oppo. The One who buys Mi does not belong to Gurgaon and Noida. L does not buy Oppo.

Q106. Who among the following belongs to Surat?

- (a) J
- (b) L
- (c) N
- (d) O
- (e) None of these

Q107. Who among the following person buy Oppo?

- (a) The one who belongs to Jaipur
- (b) L
- (c) The one who belongs to Noida
- (d) M
- (e) The one who belong to Gurgaon

Q108. Which of the following combination is true?

- (a) Jaipur-Vivo
- (b) Delhi-Apple
- (c) Rewari- Mi
- (d) Noida-Oneplus
- (e) None is true

Q109. Who among the following person buys Samsung?

- (a) M
- (b) N
- (c) L
- (d) J
- (e) K

Q110. O belongs to which of the following place?

- (a) Noida
- (b) Delhi
- (c) Agra
- (d) Gurgaon
- (e) Surat

Directions (111-115): Study the information carefully and answer the questions given below.

Six persons are sitting around a triangular table. Some of them face towards the center and some of them face outside the center. Three persons sits each of the corner of table and rest sits middle of each side of table.

P sits second to the right of B. One person sits between H and M. R is not immediate neighbor of P. L and R sits immediate left to each other. R does not sit at corner of triangle. P face towards center and M does not sit immediate right of P. More than three persons face towards center. M and L face opposite direction to each other. M does not face towards center. R is not immediate neighbor of B. L is not an immediate neighbour of P.

Q111. Who among the following sits immediate right of R?

- (a) H
- (b) L
- (c) P
- (d) B
- (e) None of these

Q112. Which of the following group of person sit at corner of table?

- (a) H, P, M
- (b) H, B, P
- (c) M, L, H
- (d) H, R, L
- (e) None of these

Q113. Who among the following sits third to the right of L?

- (a) M
- (b) H
- (c) R
- (d) B
- (e) None of these

Q114. Which of the following statement is true about P?

- (a) P sits immediate right of M
- (b) Two persons sit between P and R
- (c) No one sit between H and P
- (d) P sits fourth to the right of B
- (e) None is true

Q115. How many persons face outside the center?

- (a) One
- (b) Three
- (c) Four
- (d) None
- (e) Two

Directions (116-120): Study the information carefully and answer the questions given below.

Seven persons J, K, L, M, N, O and P are going for holiday in seven different months of the same year i.e. January, March, April, May, June, July and August but not necessary in same order.

M goes in the month which has even number of days. One person goes between M and P. K goes after M. More than one person go between M and L. O goes just after L. Not more than two person goes between K and P. J does not go in the month which has odd number of day. N does not go in May.

Q116. In which of the following month P goes?

- (a) June
- (b) April
- (c) August
- (d) January
- (e) None of these

Q117. Who of the following person goes on April?

- (a) K
- (b) M
- (c) O
- (d) P
- (e) None of these

Q118. How many persons go between N and O?

- (a) Three
- (b) Two
- (c) Four
- (d) Five
- (e) None of these

Q119. Four of the following five are alike in certain way based from a group, find the one that does not belong to that group?

- (a) P
- (b) K
- (c) O
- (d) M
- (e) N

Q120. Which of the following person goes just before M?

- (a) O
- (b) P
- (c) K
- (d) J
- (e) None of these

Q121. If all the letters in the word MEMORIZE are arranged in alphabetical order from left to right in such a way that vowels are arranged first followed by consonants, then how many letters are there in between I and R after the arrangement?

- (a) Two
- (b) None
- (c) Three
- (d) Five
- (e) One

Q122. The position of how many alphabets will remain unchanged if each of the alphabets in the word 'Firecracker' is arranged in alphabetical order from left to right?

- (a) Four
- (b) Three
- (c) None
- (d) One
- (e) Two

Q123. How many pairs of letters are there in the word "Prediction" each of which have as many letters between them in the word as they have between them in the English alphabetical series?

- (a) One
- (b) Two
- (c) Three
- (d) More than three
- (e) None

Q124. In a certain code, ROOMMATE is written as NPPSFUBN. How is SCRABBLE written in the code?

- (a) TDSBCCFM
- (b) FMCCBSDT
- (c) BSDTFMCC
- (d) BSDZFMCC
- (e) None of these

Q125. If in the number 463965812, 2 is added to each of the digit which is less than and equal to 5 and 3 is subtracted from each of the digit which is greater than five then all the numbers are arranged in decreasing order from right to left then how many digits position remain same in new arrangement?

- (a) Three
- (b) None
- (c) One
- (d) Two
- (e) Four

Directions (126-128): Read the given information carefully and answer the given questions.

There are six J, K, L, M, N, and O boxes in a room, each having different numbers of toffee. M has more toffees than only 2 boxes. J has more toffee than N but less toffee than O. J has more toffee than L but less toffee than K. N is not the box which has the lowest number of toffee. K doesn't have an odd number of toffees. The box which has 2nd highest number of toffees has 25 toffees.

Q126. If the box M has 17 toffees, then what will be the possible number of toffees does J have?

- (a) 27
- (b) 28
- (c) 18
- (d) 14
- (e) None of these

Q127. Which of the following box has the third-highest number of toffees?

- (a) K
- (b) N
- (c) O
- (d) J
- (e) None of these

Q128. Which of the following Box has the highest number of toffees?

- (a) O
- (b) K
- (c) J
- (d) N
- (e) None of these

Directions (129-130): In each of the question, relationships between some elements are shown in the statements. These statements are followed by conclusions numbered I and II. Read the statements and give the answer.

- (a) If only conclusion I follows.
- (b) If only conclusion II follows.
- (c) If either conclusion I or II follows.
- (d) If neither conclusion I nor II follows.
- (e) If both conclusion I and II follows.

Q129. Statements: $W \geq Y > U \leq C = M > K > L$

Conclusions:

- I. $L < C$
- II. $U \leq W$

Q130. Statements: $P = O \geq L > T < M < J > E \geq R$

Conclusions:

- I. $J > T$
- II. $T \leq J$

Directions (131-135): In each of the questions below are given some statements followed by some conclusions. You have to take the given statements to be true even if they seem to be at variance with commonly known facts. Read all the conclusions and then decide which of the given conclusions logically follows from the given statements, disregarding commonly known facts. Give answer

Q131. Statements:

- Only a few Party is Music.
- Some Music is Loud.
- No Loud is Mute.

Conclusions:

- I. Some Loud is not Party
 - II. All Mute is Music is a possibility
- (a) Both I and II follow
 - (b) Either I or II follows
 - (c) Only II follows.
 - (d) Only I follows.
 - (e) Neither I nor II follows

Q132. Statements:

Only Soul is Pure.

Some Evil is Soul.

Only a few Evil is good.

Conclusions:

I. All Good is Soul is a possibility

II. Some Pure is Evil is a possibility

(a) Both I and II follow

(b) Either I or II follows

(c) Only II follows.

(d) Only I follows.

(e) Neither I nor II follows

Q133. Statements:

Only a few Magenta is Blue.

No Magenta is Yellow.

Only Magenta is Pink.

Conclusions:

I. Some Blue is not Yellow

II. All Yellow is blue is a possibility

(a) Both I and II follow

(b) Either I or II follows

(c) Only II follows.

(d) Only I follows.

(e) Neither I nor II follows

Q134. Statements:

Some Home is Hut.

No House is Hut.

No Hut are Villa.

Conclusions:

I. Some House is not Villa

II. All House is Villa

(a) Both follow.

(b) Only I follows.

(c) Only II follows.

(d) Either I or II follows.

(e) None of these

Q135. Statements:

Some Ugly are Beauty.

Some Pretty are Cute.

No Ugly is Cute.

Conclusion:

- I. Some Pretty is not Ugly
II. Some Beauty is not Cute
- (a) None of these
(b) Only II follows.
(c) Either I or II follows.
(d) Both I and II follow.
(e) Only I follows.

Directions (136-140): In each of the questions below. Some statements are given followed by conclusions/group of conclusions numbered I and II. You have to assume all the statements to be true even if they seem to be at variance from the commonly known facts and then decide which of the given two conclusions logically follows from the information given in the statements.

- (a) If only conclusion I follows
(b) If only conclusion II follows
(c) If either I or II follows
(d) If neither I nor II follows
(e) If both I and II follow

Q136. Statements:

All Noun are Article.
No Article is Verb.
Some verb is Tense.

Conclusions:

- I. Some Tense is Noun is a possibility
II. Some Noun is Verb

Q137. Statements:

No Water are Bubble.
All Bubble is Clear.
Only Clear are Rain

Conclusions:

- I. No Rain is Water
II. Some Clear is water

Q138. Statements:

Some Video are Audio.
All Picture are Video.
No Study is picture.

Conclusions:

- I. Some Video are Picture is a possibility.
II. No Audios is Study.

Q139. Statements:

Only a few Green are Purple

All Purple are Black

No Green is Blue

Conclusions:

I. Some Purple is Blue

II. All Green is Black is a possibility

Q140. Statements:

Some Lines are Square

Some Square are Circle

No Square are Graphs

Conclusions:

I. Some Line is Graph

II. Some Circle is line

Directions (141-145): In each of the questions below are given some statements followed by some Conclusions. You have to take the given statements to be true even, if they seem to be at variance from commonly known facts. Read all the conclusions and then decide which of the given conclusions logically follows from the given statements disregarding commonly known facts.

(a) If both conclusions I and II follow.

(b) If either conclusion I or II follows.

(c) If neither conclusion I nor II follows.

(d) If only conclusion II follows.

(e) If only conclusion I follows.

Q141. Statements:

Some wire are blue

Only a few blue is road

All road are green

Conclusion:

I: All blue can be green

II: Some road are wire

Q142. Statements:

All text are camera

Some camera are lens

No lens is red

Conclusion:

I: All text can never be red

II: Some camera are not red

Q143. Statements:

Some copy are paste

Only paste is cut

Some paste is page

Conclusions:

I. No copy is page

II. Some copy is page

Q144. Statements:

All knife are sharp

All sharp are pencil

Some sharp are pen

Conclusions:

I. No pencil are pen

II. Some pen are pencil

Q145. Statements:

No star are shine

Some shine are light

No stone is star

Conclusions:

I: Some light are not star

II: All stone can never be light

Directions (146-150): In each of the questions given below some statements are followed by some conclusions. You have to take the given statements to be true even if they seem to be at variance from commonly known facts. Read all the conclusions and then decide which of the given conclusions logically follows from the given statements disregarding commonly known facts.

Q146. Statements:

Some month are year

All year are days

All days are paper

Conclusions:

I. Some month are not paper.

II. All days are month.

III. All month are paper.

(a) Only I follows

(b) Only II follows

(c) Either I or III follows

(d) Only III follows

(e) None follows

Q147. Statements:

Some Monday is Tuesday.

Some Tuesday is Friday.

All Friday is Sunday.

Conclusion:

I. Some Monday is Sunday

II. Some Tuesday is Sunday.

III. Some Monday is Friday.

(a) Only I follows

(b) Only II follows

(c) Both I and II follow

(d) Only III follows

(e) None follows

Q148. Statements:

Some design are system.

All system is Web.

All design is Device.

Conclusions:

I. Some Device is system.

II. All web are design.

III. All system are design.

(a) Only II follows

(b) Both I and III follow

(c) Both II and III follow

(d) Both I and II follow

(e) None of these

Q149. Statements:

Some article are video

No Video is audio

Only a few audio are bottle

Conclusion:

I. Some audio are aricle

II. All bottle can be article

III. All audio can be bottle

(a) Both II and III follow

(b) Only II follows

(c) Both I and II follow

(d) Both I and III follow

(e) Only I follows

Q150. Statements:

Only a few Red are computer

All CPU are computer

All Internet are computer

Conclusion:

I. Some internet are CPU

II. All Computer can be red.

III. No CPU is internet

(a) Only II follows

(b) Either I or III follows

(c) Only I follows

(d) None follows

(e) Either I or III and II follow

Directions (151-155): In each of the questions below are given some statements followed by some Conclusions. You have to take the given statements to be true even, if they seem to be at variance from commonly known facts. Read all the conclusions and then decide which of the given conclusions logically follows from the given statements disregarding commonly known facts.

(a) If only conclusion I follows.

(b) If only conclusion II follows.

(c) If either conclusion I or II follows.

(d) If neither conclusion I nor II follows.

(e) If both conclusions I and II follow.

Q151. Statements:

Some frames are circular.

Some rectangle are frames.

Only frames are keys

Conclusion:

I: All circular is Frames is a possibility

II: Some rectangles are keys

Q152. Statements:

All Sea are lake.

All sea are example

Conclusion:

I: Some lake are example

II: All lake can be Example

Q153. Statements:

All metals are fibres

All wings are plastic.

No metal is wing.

Conclusion:

I: Some fibres are metal.

II: Some plastic are not metal

Q154. Statements:

Some wrong are right.

No solution is wrong.

No logic is right.

Conclusion:

I: No logic is a solution

II: No right is a solution

Q155. Statements:

Some drink are virus

All drink are software

No drink is water.

Conclusion:

I: All virus can never be water.

II: Some water can never be software

Directions (156-160): In each of the questions below. Some statements are given followed by some conclusions. You have to assume all the statements to be true even if they seem to be at variance from the commonly known facts and then decide which of the given conclusion logically follows from the information given in the statements.

(a) If only conclusion I follows

(b) If only conclusion II follows

(c) If either I or II follows

(d) If neither I nor II follows

(e) If both I and II follow

Q156. Statements: No book is novel

All story is novel

Some cartoon is story

Conclusions:

I. Some cartoon is not book is a possibility

II. All book are cartoon is a possibility

Q157. Statements: All picture is colour

All draw are picture

Some painting is colour

Conclusions:

I. Some colour are draw

II. All painting are picture is a possibility

Q158. Statements: All house is castle

All palace is villa

No castle is palace

Conclusions:

I. No villa is house

II. Some palace are castle

Q159. Statements: All white are winter

Some snow is white

Some winter are freeze

Conclusions:

I. All snow being freeze is a possibility

II. Some white are definitely not freeze.

Q160. Statements: Some blue are green

Some grey is blue

All green are white

Conclusions:

I. All grey can never be white

II. All green are grey is a possibility

Directions (161-165): In these questions some statements are followed by some conclusions numbered. You have to take the three given statements to be true even if they seem to be at variance from commonly known facts and then decide which of the given conclusions logically follows from the given statements disregarding commonly known facts.

Q161. Statements:

All hard are tough.

No tough is a question.

Some question are exam.

Conclusions:

I. All hard being exam is a possibility.

II. No hard is a question.

(a) Only I follows.

(b) Only II follows.

(c) Both I and II follow.

(d) Either I or II follows.

(e) Neither I nor II follows.

Q162. Statements:

All eraser are sharpener.

Only Few pencil are eraser.

No pencil is Pen

Conclusions:

I. No eraser is a pen.

II. All sharpeners are pencil is a possibility.

- (a) Only I follows.
- (b) Only II follows.
- (c) Either I or II follows.
- (d) Neither I nor II follows.
- (e) Both I and II follow.

Q163. Statements:

All white is blue.

Some blue is olive.

No olive is an grey.

Conclusions:

I. Some white is olive.

II. Some grey being blue is a possibility.

- (a) Either I or II follows.
- (b) Both I and II follow.
- (c) Only I follows.
- (d) Neither I nor II follows.
- (e) Only II follows.

Q164. Statements:

All earth are suns.

No sun are moon.

Few moon are Jupiter.

Conclusions:

I. All earth are Jupiter.

II. No sun is a Jupiter.

- (a) Either I or II follows.
- (b) Only II follows.
- (c) Neither I nor II follows.
- (d) Only I follows.
- (e) Both I and II follow.

Q165. Statements:

All rectangle is square.

Some squares are circles.

No rectangle is a triangle.

Conclusions:

- I. All squares can never be triangle.
II. At least some rectangle is circle.
- (a) Either I or II follows.
(b) Both I and II follow.
(c) Neither I nor II follows.
(d) Only I follow.
(e) Only II follows.

Directions (166-170): In each of the questions below are given some statements followed by some Conclusions. You have to take the given statements to be true even, if they seem to be at variance from commonly known facts. Read all the conclusions and then decide which of the given conclusions logically follows from the given statements disregarding commonly known facts.

- (a) If only conclusion I follows.
(b) If only conclusion II follows.
(c) If either conclusion I or II follows.
(d) If neither conclusion I nor II follows.
(e) If both conclusions I and II follow.

Q166. Statements:

Some Rain are Magic
All Magic are Jungle
No Jungle is Green

Conclusion:

- I: Some Rain are Green
II: No rain is Green

Q167. Statements:

Some Dance are Amazing
No amazing are Right
Only a few Right are Wrong

Conclusion:

- I: Some wrong are not amazing
II: All Dance can never be Wrong

Q168. Statements:

Only a few Tree are Green
All Yellow is Green
Only a few Orange is Green

Conclusions:

- I. All orange can be Yellow
II. Some yellow can be Green

Q169. Statements:

Only Red is Blue

Some Red is White

Only a few White is Number

Conclusions:

I. All white can be Red

II. All Red can be Number

Q170. Statements:

All Grapes are Mango

Some Mango are apple

No apple are Brown

Conclusions:

I: All Apple can never be Mango

II: Some Mango are not Brown

Directions (171-175): Study the following information carefully and answer the questions given below. Eight persons were born on two different dates either 22nd or 25th of the same year (that is not a leap year) but in different month- January, February, March and April. G is younger than F. H was born in the month which have even number of days and on even number date. Only two persons was born in between B and E. C was born on 25th of the month which have even numbers of days. Not more than three persons were born before D. A is the third youngest person in the group. E was born in the month which have 31 days. D is younger than H. G was born in the month which have even numbers of days. More than three persons was born in between B and G.

Q171. Who among the following was born on 22nd March?

(a) H

(b) G

(c) E

(d) F

(e) None of these

Q172. How many persons were born after B?

(a) Six

(b) Five

(c) Three

(d) One

(e) None

Q173. Which of the following pair of persons was born in February?

(a) A-B

(b) D-F

(c) G-C

(d) H-D

(e) None of these

Q174. Which of the following is true about F?

- (a) F was born in March
- (b) F is the oldest person
- (c) F was born on an odd numbered date
- (d) Only three persons are younger than F
- (e) None of these

Q175. Which of the following month-date combination is true about C?

- (a) January-25th
- (b) March-22nd
- (c) February-22nd
- (d) April-25th
- (e) None of these

Directions (176-180): Read the following information carefully and answer the questions given below: Eight persons A, B, C, D, M, N, O, and P are seating in a row, some are facing north and some are facing south but not necessarily in the same order. D sits 4th right of B. C sits left of N. M, D and N are facing in same direction. O doesn't sit just near to N. A sits at one of the extreme ends and B sits 2nd to right of A. C and O are immediate neighbors of each other, none of them sits at any of the extreme end. M doesn't sit just near to both B and N. Immediate neighbors of B face opposite direction of B. C and O face same direction but O doesn't face south direction. N sits 3rd from one of the extreme ends.

Q176. Who among the following sits 2nd left of the one who sits immediate right of B?

- (a) A
- (b) M
- (c) N
- (d) C
- (e) None of these

Q177. What is the position of A with respect to B?

- (a) 4th to the left
- (b) 3rd to the left
- (c) Immediate left
- (d) 4th to the right
- (e) None of these

Q178. P is facing in which direction?

- (a) North
- (b) South
- (c) Same as C faces
- (d) Both a and c
- (e) None of these

Q179. Who among the following sits immediate left of A?

- (a) P
- (b) B
- (c) No one
- (d) O
- (e) None of these

Q180. How many persons sit to the left of C?

- (a) One
- (b) Three
- (c) More than three
- (d) Two
- (e) None of these

Q181. If 2 is subtracted from each odd digit in the number 9758462587 and 1 is added to each even digit in number then how many digits of the following number is repeated more than three times in the new number so obtained?

- (a) none
- (b) one
- (c) two
- (d) three
- (e) more than three

Q182. How many pairs of letters are there in the word "NARENDRAMODI" which have as many letters between them in the word as in the alphabetical series?

- (a) one
- (b) more than three
- (c) three
- (d) none
- (e) two

Q183. How many meaningful words can be formed using the 3rd, 4th, 6th and 7th alphabet of the word "PUBLICATIONS"?

- (a) one
- (b) more than three
- (c) three
- (d) none
- (e) two

Q184. Mohit is 15th from the left end of a row and Ram is 22th from the right end of row. If they interchanged their positions then Ram ranks become 16th from right end. Find total number of persons in the row?

- (a) 30
- (b) 29
- (c) 31
- (d) 25
- (e) Can't be determined

Q185. Showing a woman on the stage, Ravi said, "She is the aunt of the son of only brother of my wife. How is the woman on stage related to Ravi?

- (a) Wife
- (b) Brother
- (c) Mother in law
- (d) Sister in law
- (e) Mother

Directions (186-190): Study the following information carefully to answer the given questions:

Seven persons i.e. A, B, C, D, E, F and G who all like different colours i.e. Green, Red, Blue, Yellow, Black, Pink and White but not necessarily in the same order. D likes Black colour. Neither A nor E likes Pink colour. Neither F nor A likes Yellow colour. Neither A, B nor E likes Green Colour. Neither B nor E likes Yellow colour. Neither C nor F likes Green colour. B does not like pink and white colour. A does not like white and Red colour.

Q186. A like which of the following colour?

- (a) Pink
- (b) Red
- (c) Blue
- (d) White
- (e) None of these

Q187. Which of the following combination of colour and person is correct?

- (a) C-Yellow
- (b) A-White
- (c) B-Pink
- (d) D-Yellow
- (e) None of these

Q188. Who among the following likes Pink colour?

- (a) E
- (b) F
- (c) D
- (d) G
- (e) None of these

Q189. Which of the following combination is incorrect?

- (a) A-Blue
- (b) C-Yellow
- (c) G-Green
- (d) E-Pink
- (e) All are correct

Q190. Who among the following likes white colour?

- (a) A
- (b) E
- (c) G
- (d) F
- (e) None of these

Directions (191-195): Study the following information to answer these questions.

Seven persons A, B, C, D, E, F, G are friends who are from different profession viz. Engineer, Doctor, Pilot, Teacher, Manager, Politician and Businessman, not necessarily in the same order. Each one belongs to different states viz. Gujarat, Kerala, Manipur, Delhi, Uttarakhand, Assam and Orissa but not necessarily in the same order.

D is a Pilot and B does not belong to Assam and Manipur. C is from Delhi and he is a Doctor. The person who is a Teacher belongs to Uttarakhand. A, who belongs to Gujarat but does not have profession of Engineer. F who belongs to Kerala is a Businessman. Orissa is the native place of G who is a Manager.

Q191. Which of the following person is Engineer?

- (a) A
- (b) D
- (c) E
- (d) D or E
- (e) None of these

Q192. Who among the following belongs to Assam?

- (a) D
- (b) E
- (c) F
- (d) G
- (e) Can't be determined

Q193. The one who belongs to Gujarat have which of the following profession?

- (a) Manager
- (b) Teacher
- (c) Engineer
- (d) Politician
- (e) None of these

Q194. Which of the following combination of person, specialization and city is definitely correct?

- (a) D- Pilot-Manipur
- (b) D-Pilot-Gujarat
- (c) B-Teacher-Uttarakhand
- (d) E-Engineer-Manipur
- (e) None of these

Q195. Who among the following belongs to Uttarakhand?

- (a) B
- (b) D
- (c) E
- (d) Data inadequate
- (e) None of these

Directions (196-200): Study the information carefully and answer the questions given below.

There are eight boxes viz. P, Q, R, S, T, U, V and W are placed one above other in the stack but not necessary in same order.

There are four boxes between R and W. Two box between W and P. There are three boxes between P and U. There are two boxes between U and Q. There is only one box between Q and S. The box S is not placed immediately above and immediately below box U. There are gap of two boxes between T and V. The box T is placed at one of the position above W but not on the top.

Q196. How many boxes are placed below the box T?

- (a) One
- (b) Two
- (c) Three
- (d) None
- (e) Four

Q197. Which of the following box is at the bottom?

- (a) V
- (b) Q
- (c) R
- (d) S
- (e) T

Q198. How many boxes are placed between the box S and W?

- (a) Four
- (b) Three
- (c) Two
- (d) One
- (e) None

Q199. Which of the following box is placed immediately above S?

- (a) Q
- (b) T
- (c) W
- (d) R
- (e) P

Q200. If R is related to Q and P is related to W in certain way, then S is related to ?

- (a) Q
- (b) T
- (c) W
- (d) R
- (e) P

Directions (201-205): In these questions, relationship between different elements is shown in the statements. The statements are followed by conclusions. Study the conclusions based on the given statements and select the appropriate answer.

Q201. Statement: $Q < L \leq A > M = K \geq E$

Conclusions:

I. $K \leq L$

II. $Q < E$

- (a) Only conclusion II is true
- (b) Either conclusion I or II is true
- (c) Both conclusions I and II are true
- (d) Neither conclusion I nor II is true
- (e) Only conclusion I is true

Q202. Statements: $D < A; Q > R = A < Y$

Conclusions:

I. $Q > D$

II. $D < Y$

- (a) Both conclusions I and II are true
- (b) Only conclusion I is true
- (c) Neither conclusion I nor II is true
- (d) Either conclusion I or II is true
- (e) Only conclusion II is true

Q203. Statements: $Q > R = A < Y; D < A$

Conclusions:

I. $Q < Y$

II. $R \leq D$

- (a) Both conclusions I and II are true
- (b) Neither conclusion I nor II is true
- (c) Only conclusion I is true
- (d) Only conclusion II is true
- (e) Either conclusion I or II is true

Q204. Statements: $T \geq R > A$; $R < P < Q$; $A = S \leq H$

Conclusions:

I. $T > S$

II. $P < T$

- (a) Either conclusion I or II is true
- (b) Both conclusions I and II are true
- (c) Only conclusion II is true
- (d) Neither conclusion I nor II is true
- (e) Only conclusion I is true

Q205. Statements: $T \geq R > A = S \leq H$; $R < P < Q$

Conclusions:

I. $H \geq R$

II. $R < Q$

- (a) Both conclusions I and II are true
- (b) Only conclusion II is true
- (c) Only conclusion I is true
- (d) Either conclusion I or II is true
- (e) Neither conclusion I nor II is true

Directions (206-210): In each of the question, relationships between some elements are shown in the statements(s). These statements are followed by conclusions numbered I and II. Read the statements and give the answer.

- (a) If only conclusion I follows.
- (b) If only conclusion II follows.
- (c) If either conclusion I or II follows.
- (d) If neither conclusion I nor II follows.
- (e) If both conclusions I and II follow.

Q206. Statements: $F \leq S > U$, $H > S$, $L < S$

Conclusions:

I. $L > U$

II. $H > U$

Q207. Statements: $W > C > N > H > O < J \leq K$

Conclusions:

I. $W > K$

II. $J \geq C$

Q208. Statements: $P < N < Z > W$, $X < Z$

Conclusions:

I. $Z > P$

II. $X = P$

Q209. Statements: $J \geq K > S > F < O, Y < O, F > Z$

Conclusions:

I. $J > F$

II. $K > Z$

Q210. Statements: $Q < X < Z \geq J > U, Z > Y$

Conclusions:

I. $X < Y$

II. $Z > Q$

Directions (211-215): In these questions, relationship between different elements is show in the statements. The statements are followed by conclusions. Study the conclusions based on the given statements and select the appropriate answer:

Q211. Statements: $N > Z \geq Y = J \leq K < Q \leq B; A \geq Z > C$

Conclusions:

I. $Y < B$

II. $C \geq Q$

- (a) Both conclusions I and II are true
- (b) Either conclusion I or II is true
- (c) Only conclusion I is true
- (d) Neither conclusions I nor II is true
- (e) Only conclusion II is true

Q212. Statements: $N > Z \geq Y = J \leq K < Q \leq B; A \geq Z > C$

Conclusions:

I. $A = J$

II. $A > J$

- (a) Both conclusions I and II are true
- (b) Only conclusion II is true
- (c) Neither conclusion I nor II is true
- (d) Either conclusions I or II is true
- (e) Only conclusions I is true

Q213. Statements: $T < I = Z \leq H; G < I$

Conclusions:

I. $H > T$

II. $H > G$

- (a) Both conclusion I and II are true
- (b) Either conclusion I or II is true
- (c) Neither conclusion I nor II is true
- (d) Only conclusion I is true
- (e) Only conclusion II is true

Q214. Statements: $K = F < N < P \leq R > M; W \geq K; R \geq X$

Conclusions:

I. $N < X$

II. $M > F$

- (a) Only conclusion II is true
- (b) Either conclusion I or II is true
- (c) Both conclusion I and II are true
- (d) Neither conclusion I nor II is true
- (e) Only conclusion I is true

Q215. Statements: $K = F < N < P \leq R > M; W \geq K; R \geq X$

Conclusions:

I. $W \geq P$

II. $R > K$

- (a) Neither conclusion I nor II is true
- (b) Both conclusions I and II are true
- (c) Only conclusion II is true
- (d) Either conclusion I or II is true
- (e) Only conclusion I is true

Direction (216-220): In these questions, relationship between different elements is show in the statements. The statements are followed by conclusions. Study the conclusions based on the given statements and select the appropriate answer:

- (a) If only conclusion I follows.
- (b) If only conclusion II follows.
- (c) If either conclusion I or II follows
- (d) If neither conclusion I nor II follows.
- (e) If both conclusions I and II follow.

Q216. Statements: $Q > Y < O < C > L \geq K = J > M$

Conclusion:

I: $Q < O$

II: $M < C$

Q217. Statements: $X < M \leq D > T = R \leq W < Z$

Conclusion

I: $D \geq X$

II: $T < Z$

Q218. Statements: $W = P \geq L = K \geq J = V < N$

Conclusion

I: $K < W$

II: $W = K$

Q219. Statements: $A > S < B \geq E > L \leq Z > J = R$

Conclusion

I: $Z \geq B$

II: $B > Z$

Q220. Statements: $V = G > H = N \geq L < O = T$

Conclusion

I: $L < G$

II: $T > N$

Directions (221-224): In each of the question, relationships between some elements are shown in the statements. These statements are followed by conclusions numbered I and II. Read the statements and give the answer.

- (a) If only conclusion I follows.
- (b) If only conclusion II follows.
- (c) If either conclusion I or II follows.
- (d) If neither conclusion I nor II follows.
- (e) If both conclusions I and II follow.

Q221. Statements: $P < R \leq M = L > O \leq V > Y$

Conclusions: I. $L > P$ II. $O > R$

Q222. Statements: $A \geq B > D = F < E \leq C$

Conclusions: I. $B > E$ II. $D < C$

Q223. Statements: $A = E \geq D \geq C < F \leq B$

Conclusions: I. $C < A$ II. $A = C$

Q224. Statements: $F \geq N = O > P \leq K > T$

Conclusions: I. $K < F$ II. $N < K$

Q225. If in the number 639429687, 1 is added to each of the digit which is less than five and 1 is subtracted from each of the digit which is greater than five then how many digits are repeating in the number thus formed?

- (a) Two
- (b) One
- (c) None
- (d) Three
- (e) Four

Q226. The position of how many alphabets will remain unchanged if each of the alphabets in the word 'TRANSPORT' is arranged in alphabetical order from left to right?

- (a) Four
- (b) Three
- (c) None
- (d) One
- (e) Two

Q227. Which of the following elements should come in a place '?' ?

DF8 HJ12 LN16 ?

- (a) PR19
- (b) PR18
- (c) PR21
- (d) PR22
- (e) None of these

Q228. Which of the following symbols should replace the sign (@) and (%) respectively in the given expression in order to make the expression $B \geq C$ and $H > K$ definitely true?

$B \geq D \geq F = E = K @ C \leq A \% H$

- (a) $\leq, =$
- (b) \leq, \leq
- (c) $>, \leq$
- (d) $=, <$
- (e) $\geq, <$

Q229. Which of the following will be definitely true if the given expression $A \geq D \geq G = K < H = M < Q \leq R$ is definitely true?

- (a) $A < H$
- (b) $D > G$
- (c) $R > K$
- (d) $R \geq G$
- (e) $A < M$

Directions (230-234): In these questions, relationships between elements are shown in the statements. These statements are followed by two conclusions. Give answer-

- (a) If only conclusion I follows.
- (b) If only conclusion II follows.
- (c) If either conclusion I or conclusion II follows.
- (d) If neither conclusion I nor conclusion II follows.
- (e) If both conclusions I and II follow.

Q230. Statements: $G \leq F = L \leq J$; $J \leq K = H$

Conclusions: I. $H = G$ II. $G < H$

Q231. Statements: $P < R \leq S < T > U \geq Q > W$

Conclusions: I. $W > S$ II. $T > P$

Q232. Statements: $T > U \geq V \geq W$; $X < Y = W > Z$

Conclusions: I. $Z > U$ II. $W < T$

Q233. Statements: $K < L < M < N$; $M < O < P$

Conclusions: I. $P > K$ II. $N > O$

Q234. Statements: $B < A < C$; $A > D \leq E$

Conclusions: I. $B \leq E$ II. $C > E$

Directions (235-237): Study the information carefully and answer the questions given below.

Point X is 4m west of point K. Point K is 10m north of point H. Point H is 2m north of point B. Point B is 4m south of point G. Point G is 6m east of point M. Point M is 9m west of point T.

Q235. What is the shortest distance between T and B?

- (a) 5m
- (b) 6m
- (c) 3m
- (d) 7m
- (e) None of these

Q236. In which direction point X with respect to point B?

- (a) South-west
- (b) North-east
- (c) North-west
- (d) North
- (e) None of these

Q237. If point O is 7m north of point M then in which direction point O with respect to point K?

- (a) North-west
- (b) North-east
- (c) South-west
- (d) South-east
- (e) None of these

Directions (238-240): Study the information carefully and answer the questions given below.

Six persons in the family having six different age. P is older than Q. T is older than P. S is younger than R. P is third youngest person in the family. R is younger than V and older than S. T is not older than R. S is not the youngest person. The age of second oldest is 55years.

Q238. Who among the following person is older than T?

- (a) P
- (b) S
- (c) V
- (d) R
- (e) Both (c) and (d)

Q239. How many persons are older than S?

- (a) Three
- (b) Four
- (c) Five
- (d) One
- (e) None of these

Q240. If age of P is 50 years then what may be the age of T?

- (a) 51yr
- (b) 45yr
- (c) 57yr
- (d) 62yr
- (e) 47yr

Q241. How many such pairs of letters (Both forward and backward direction) are there in the word "Basketball", each of which has as many alphabets between them as they have according to English alphabetical series?

- (a) None
- (b) One
- (c) Two
- (d) Three
- (e) More than three

Q242. In a class, Mohit rank is 21st from the right and Aman's rank is 21st from the left and Ankur sits second to the left of Mohit who is sitting on the immediate right of Aman, then how many students are there in the class?

- (a) 45
- (b) 39
- (c) 42
- (d) 44
- (e) 46

Directions (243-247): Study the information carefully and answer the questions given below.

Point H is 5m west of point K. Point K is 13 north of point J. Point J is 8m east of point V. Point V is 5m north of point L. Point L is 2m west of point C. Point C is 8m south of point P. Point P is 4m west point X. Point X is south of point W, which is west of point K.

Q243. What is the shortest distance between point X and point W?

- (a) 10m
- (b) 11m
- (c) 8m
- (d) 9m
- (e) None of these

Q244. In which direction point X with respect to point J?

- (a) South-east
- (b) North-west
- (c) North
- (d) South
- (e) None of these

Q245. What is the shortest distance between point P and J?

- (a) 7m
- (b) 9m
- (c) $\sqrt{45}$ m
- (d) 8m
- (e) None of these

Q246. If point S is south of point H and east of point P then what is the shortest distance between point S and P?

- (a) 2m
- (b) 3m
- (c) 1m
- (d) 4m
- (e) None of these

Q247. Four of the following five are alike in certain way based from a group, find the one that does not belong to that group?

- (a) H-X
- (b) P-J
- (c) K-P
- (d) V-C
- (e) W-J

Q248. If all the letters in the word DISCUSSION are arranged in alphabetical order from right to left in such a way that vowels are arranged first followed by consonants, then how many letters position remains same in new arrangement?

- (a) One
- (b) Three
- (c) Two
- (d) None
- (e) Five

Directions (249-250): Study the following information carefully and answer the given questions.

Amongst Six friends, P, Q, R, S, T and U, each got different marks in the examination. Only two persons score more than T. R score more than S. P score less than U. P score more than T. S does not score least. The one who score lowest marks score 40 marks.

Q249. Who scored the lowest marks?

- (a) Q
- (b) R
- (c) P
- (d) S
- (e) None of these

Q250. If R score 45 marks than what may be the score of S?

- (a) 39
- (b) 50
- (c) 46
- (d) 43
- (e) 47

Q251. How many pairs of letters (both forward and backward direction) are there in the word "ESPECIALLY" each of which has as many letters between them in the word as they have between them in the English alphabetical series?

- (a) Two
- (b) Four
- (c) Three
- (d) More than Four
- (e) None

Q252. If in the number 536712493, 3 is subtracted to each of the digits which is greater than 4 and 2 is added from each of the digit which is less than 5, then all the digit are arranged in increasing order from right to left in such a way that even number arranged first then odd number arranged how many digits are remains at same position in new arrangement?

- (a) One
- (b) Three
- (c) Four
- (d) None
- (e) None of these

Directions (253-257): Study the information carefully and answer the questions given below.

Point A is 9m west of point H. Point H is 12m north of point G. Point G is 3m east of point L. Point L is 7m south of point B. Point B is 10m south of point V. Point V is 4m west of point Z. Point Z is 6m north of point C. Point C is east of point M, which is south of point A.

Q253. What is the shortest distance between point C and point M?

- (a) 9m
- (b) 10m
- (c) 8m
- (d) 7m
- (e) None of these

Q254. In which direction point Z is with respect to point H?

- (a) North
- (b) North-east
- (c) North-west
- (d) South
- (e) South west

Q255. What is the shortest distance between Point M and Point L?

- (a) 13m
- (b) 12m
- (c) $\sqrt{157}$ m
- (d) 14m
- (e) $\sqrt{158}$ m

Q256. If Point R is south of point C and east of point L then what is the shortest distance between Point R with respect to point G?

- (a) 4m
- (b) 3m
- (c) 1m
- (d) 2m
- (e) 5m

Q257. In which direction point B with respect to point C?

- (a) North-east
- (b) North-west
- (c) South-east
- (d) South
- (e) South west

Directions (258-259): Study the information carefully and answer the questions given below.

A person starts walking from point G he walks 10m north and reach at point H. From point H, He walks 7m in east direction and reach at point K. From point K, he walks 6m south and reach at point Y. Now he takes a right turn and walks 4m to reach at point B. After reaching at point B he start walking in south direction and reach at point M, which is east of point G.

Q258. What is the shortest distance between point B and point M?

- (a) 6m
- (b) 7m
- (c) 4m
- (d) 3m
- (e) None of these

Q259. If point S is 5m east of point M than in which direction point S with respect to point K?

- (a) North
- (b) South
- (c) South east
- (d) South west
- (e) None of these

Q260. There are five persons i.e. P, Q, R, S and T. If S is shorter than T and P. Q is taller than T who is not the taller than P. Q is taller than only two persons. P is not the tallest, then who is the second tallest person among all?

- (a) P
- (b) S
- (c) Q
- (d) R
- (e) None of these

Directions (261-162): Study the information carefully and answer the questions given below.

J, K, L, M, N and O are six members of a family. There are equal numbers of male and female in the family. J is the son of M and N is the daughter of J. K is the child of L who is the mother of N. O is Paternal grandmother of K.

Q261. How is O related to L?

- (a) Daughter-in-law
- (b) Mother-in-law
- (c) Mother
- (d) Father-in-law
- (e) Father

Q262. How is K related to M?

- (a) Daughter
- (b) Father
- (c) Son
- (d) Grandson
- (e) Granddaughter

Directions (263-264): Study the following information carefully and answer the given questions.

Amongst Six friends A, B, C, D, E and F, each got different marks in the examination. E score more than A. C score less than F. More than three person score less than B. E does not score more than C. A does not score lowest marks and F does not score highest marks. The one who scores second lowest score 60 marks.

Q263. Who among the following person score fourth highest?

- (a) C
- (b) A
- (c) E
- (d) D
- (e) None of these

Q264. If C score 80 marks, then what may be the score of E?

- (a) 63 marks
- (b) 70 marks
- (c) 52 marks
- (d) Either (a) or (b)
- (e) Can't be determined

Directions (265-266): Study the information carefully and answer the questions given below.

Point Q is 8m west of point H. Point H is 10m north of point K. Point K is 11m east of point M. Point M is 3m south of point X. Point X is 7m west of point L. Point L is south of point V, which is midpoint of point Q and H.

Q265. What is the shortest distance between Point V and point L?

- (a) 8m
- (b) 6m
- (c) 9m
- (d) 7m
- (e) None of these

Q266. In which direction point Q with respect to Point L?

- (a) North
- (b) South
- (c) North-east
- (d) North-west
- (e) None of these

Directions (267-269): Study the information carefully and answer the questions given below.

Eight persons in the three generations of the family. H is son in law of K. K is Sister in law of Y. M and L are the son of P. L is nephew of U. H does not have any sibling. U is daughter of G. Y is not married.

Q267. How is G related to P?

- (a) Father in law
- (b) Father
- (c) Mother in law
- (d) Mother
- (e) None of these

Q268. How is L related to K?

- (a) Grandfather
- (b) Grandmother
- (c) Granddaughter
- (d) Grandson
- (e) None of these

Q269. How is Y related to U?

- (a) Uncle
- (b) father
- (c) Son
- (d) Aunt
- (e) Can't be determined

Q270. How many words can be formed from the 3rd, 4th, 5th and 11th letter of a word 'PARTNERSHIP' by using each letter once in the word?

- (a) None
- (b) One
- (c) Three
- (d) Two
- (e) More than three

Q271. How many pairs of letters (both forward and backward direction) are there in the word "STRENGTHEN" each of which have as many letters between them in the word as they have between them in the English alphabetical series?

- (a) One
- (b) Three
- (c) None
- (d) More than three
- (e) Two

Direction (272-274): Study the following information carefully and answer the given questions.

There are eight members i.e. J, K, L, M, N, O, P and Q in a three generation family. M is daughter in law of Q. K is nephew of J. L is mother of J and has two child. N is granddaughter of L. J is brother in law of M. There are two married couple in the family. P is father of N. O is brother of M. There are three female members in the family. J is unmarried.

Q272. How is J related to N?

- (a) Father
- (b) Mother
- (c) Uncle
- (d) Brother
- (e) None of these

Q273. Who among is the niece of O?

- (a) J
- (b) K
- (c) P
- (d) N
- (e) None of these

Q274. Who among the following is brother in law of P?

- (a) M
- (b) O
- (c) J
- (d) Q
- (e) None of these

Q275. Pointing to a lady, Sumit says to his only son, "She is daughter in law of my mother's daughter in law". Sumit is the only Child of his parents. How is the lady related to Sumit?

- (a) Sister
- (b) Brother
- (c) Daughter-in-law
- (d) Wife
- (e) Daughter

Q276. Showing a man on the stage, Lady said, "He is the only child of the person who is grandfather of my son. How is the man on stage related to lady?"

- (a) Husband
- (b) Brother in law
- (c) Brother
- (d) Sister
- (e) Nephew

Directions (277-278): Study the information carefully and answer the questions given below.

There are nine members X, E, L, F, S, K, N, W and T in a family of three generations. S is father of W who is sister of T. X is mother of F who is brother in law of K. there is only two married couple in the family. X is sister in law of L. K is aunt of N who is child of F. L is aunt of S who has only one son. X has only two male Childs.

Q277. How is L related with respect to F?

- (a) Mother in law
- (b) Father
- (c) uncle
- (d) Aunt
- (e) Mother

Q278. how is W related to N?

- (a) Brother
- (b) Son
- (c) Grandson
- (d) cousin
- (e) None of these.

Q279. If the age of X is 48 years than what could be the most possible age of F?

- (a) 49 years
- (b) 50 years
- (c) 51 years
- (d) 24 years
- (e) 55 years

Directions (280-281): Study the information carefully and answer the questions given below.

P is father of Q who is brother in law of M who is son of S. Y has only two children one son and one daughter. K and L are grandson of S. Y is mother in law of M. T is daughter in law of S who has only one child.

Q280. What is the relation of S with respect to L?

- (a) Mother
- (b) Grand mother
- (c) Grand father
- (d) father
- (e) either (b) or (c)

Q281. How M related to P?

- (a) Mother
- (b) Daughter in law
- (c) Son in law
- (d) Cannot be determined
- (e) None of these.

Directions (282-284): Each of these questions is based on the following information:

- (i) P % Q means P is the father of Q.
- (ii) P @ Q means P is the sister of Q.
- (iii) P \$ Q means P is the brother of Q.
- (iv) P * Q means P is the wife of Q.

Q282. In the expression F \$ D % K @ H * R, how is D related to R?

- (a) Father
- (b) Mother
- (c) Sister
- (d) Father in law
- (e) None of these

Q283. In the expression A % B @ K * H % P, how is B related to P?

- (a) Aunt
- (b) Cousin
- (c) Uncle
- (d) Daughter
- (e) None of these

Q284. If U is nephew of T, which of the following expression is true?

- (a) $U @ V * R \$ T \% S$
- (b) $U \$ V * R \$ T \% S$
- (c) $V @ U @ R * T \$ S$
- (d) $R @ V \$ U * S \% T$
- (e) $S * T \$ V \% U \$ R$

Directions (285-287): Study the following information carefully and answer the given questions:

A, M, Q, J, K and S are six family members. There are only two male members in a family. M is married to Q. M is daughter-in-law of K. A and J are siblings and K is grandfather of A. K is brother of S.

Q285. How is S related to Q?

- (a) Aunt
- (b) Uncle
- (c) Mother
- (d) Daughter
- (e) None of these

Q286. How is J related to K?

- (a) Niece
- (b) Son
- (c) Grand-son
- (d) Grand-daughter
- (e) None of these

Q287. Who among the following is mother of J?

- (a) A
- (b) M
- (c) K
- (d) Q
- (e) None of these

Direction (288-289): Study the following information carefully and answer the given questions.

There are six members in a family i.e. A, F, D, B, C, and G. Among them only two are males. B is daughter of A who is father D. G is mother of F. C is Aunt of D. D is father of F.

Q288. How is F related to C's niece?

- (a) Son
- (b) Father
- (c) Niece
- (d) Daughter
- (e) None of these

Q289. Who among the following is daughter in law of A?

- (a) C
- (b) B
- (c) F
- (d) G
- (e) None of these

Direction (290-291): Study the following information carefully to answer the following question:

In a family of nine person there are 3 married couple, J is the only child of L. M is husband of J. N is grandson of L. O is brother in law of M. P is the sister of O. Q is daughter of S. R is father in law of J.

Q290. Who among the following may be the father in law of M?

- (a) P
- (b) Q
- (c) L
- (d) S
- (e) R

Q291. At least how many male members are in the family?

- (a) one
- (b) two
- (c) three
- (d) four
- (e) none of these

Q292. How many pairs of letters are there in the word "MINUTE" each of which have as many letters between them in the word as they have between them in the English alphabetical series?

- (a) Three
- (b) One
- (c) Two
- (d) More than three
- (e) None

Direction (293-295): Study the following information carefully and answer the question given below-
Point C is 12m west of point A. Point B is 18m north of point A. Point E is 9m south of point D. Point F is 14m west of point E. Point D is 28m east of point B. F is 13m south of point G.

Q293. Four of the following five belongs to a group find the one that does not belongs to that group?

- (a) CB
- (b) AD
- (c) AE
- (d) BG
- (e) FB

Q294. In which direction point A with respect to point G?

- (a) North-west
- (b) South-east
- (c) South-west
- (d) North
- (e) North-east

Q295. If Point S is 4m south of point G then what is the distance between point B and point S?

- (a) 28m
- (b) 9m
- (c) 8m
- (d) 14m
- (e) None of these

Direction (296-298): Read all the information carefully and answer the given questions:

There are eight members in the family of three generations. S is son in law of P, Who is mother of G. T is brother in law of D. M is maternal grandfather of Y, who is nephew of D. G is mother of Y. Z is sister of Y. S is not father of Y.

Q296. Who among the following is niece of D?

- (a) Y
- (b) G
- (c) Z
- (d) S
- (e) None of these

Q297. How is S related to G?

- (a) Sister in law
- (b) Brother
- (c) Brother in law
- (d) Sister
- (e) None of these

Q298. How is T related to M?

- (a) Son
- (b) Brother
- (c) Daughter in law
- (d) Sister in law
- (e) None of these

Directions (299-300): In these questions, relationship between different elements is shown in the statements. The statements are followed by conclusions. Study the conclusions based on the given statements and select the appropriate answer. Give answer-

- (a) If only conclusion II is true
- (b) If only conclusion I is true
- (c) If both conclusions I and II are true.
- (d) If either conclusion I or II is true
- (e) If neither conclusion I nor II is true.

Q299. Statements: $A > G < J$, $I < D$, $J < O = K > D$.

Conclusions: I. $G > D$ II. $O > I$

Q300. Statements: $P \geq W \leq Z$, $W > K$, $Q > O < Z$

Conclusions: I. $W > Q$ II. $Z > K$

Directions (301-305): Study the information carefully and answer the questions given below.

Eight friends J, K, L, M, N, O, P and Q are sitting around a square table in such a way that four of them sit at four corners of the square while the other four sit in the middle of each sides. The ones who sit at the four corners face towards the center while those who sit in the middle of the sides face outside (but not necessarily in the same order).

K sits second to the right of P. The one who sits opposite to K sits immediate left of L. Q sits third to the right of J. M and N sits opposite to each other. Not more than one person sit between M and Q when counted to the left of Q. O does not face outside the center.

Q301. Who among the sits immediate right of O?

- (a) M
- (b) L
- (c) K
- (d) Q
- (e) None of these

Q302. Who among the following sits second to the right of Q?

- (a) M
- (b) P
- (c) N
- (d) J
- (e) None of these

Q303. Who among the following persons sits immediate right of the one who sits opposite to J?

- (a) K
- (b) Q
- (c) P
- (d) M
- (e) None of these

Q304. Four of the following five are alike in certain way based from a group, find the one that does not belong to that group?

- (a) O
- (b) K
- (c) P
- (d) J
- (e) Q

Q305. Which of the following pair of persons sit immediate neighbor of N?

- (a) O,K
- (b) M,Q
- (c) J,P
- (d) K,P
- (e) None of these

Directions (306-310): Study the given information carefully and answer the questions that follow:

Eight friends J, K, L, M, N, O, P and Q are sitting in a linear row. Some of them face towards south direction and some of them face towards north direction. No two friends sitting together according to the alphabetical order (i.e. A does not sits immediate neighbor of B and B does not sits immediate neighbor of A). M sits 3rd to the right of J. O and M face the same direction as K is facing. The number of persons sitting to the right of P is equal to the number of person sitting on the right of M. J sits one of the extreme ends of row. L and N are immediate neighbors but both face opposite directions with respect to each other. Q sits 4th to the right of L. L does not sits on the left of P. K sits on the left of L but does not faces the same direction as J. Q faces the same direction as J and P are facing. N does not face south direction.

Q306. Who among the following sits 2nd to the right of L?

- (a) J
- (b) P
- (c) K
- (d) M
- (e) Q

Q307. How many persons face south direction?

- (a) Four
- (b) Three
- (c) One
- (d) Two
- (e) More than Four

Q308. Who among the following sits on the immediate left of J?

- (a) K
- (b) M
- (c) N
- (d) Q
- (e) No one

Q309. Who among the following sits on the immediate left of K?

- (a) L
- (b) P
- (c) J
- (d) Q
- (e) No one

Q310. J is related to O, in the same way M is related to L then who among the following follow same pattern N is related to?

- (a) P
- (b) M
- (c) Q
- (d) K
- (e) J

Direction (311-315): Study the following information carefully to answer the given questions:

The Union Budget of India for 2020–2021 was presented by the Finance Minister, Nirmala Sitharaman on 1 February 2020 as her second budget. There are different amounts (in crore) i.e- 35, 40, 55, 60, 64, 70 and 90 allocated in different ministries- Transport, Health, Energy, Defence, Telecom, Agriculture and Education.

Amount allocates to Health is more than Energy but less than Education. The amount allocates to Telecom is 1.5 times of the amount allocates to Energy. Difference between the amounts of Telecom and Transport is 10 Crore. Amount allocates to Defence is just half of the amount allocates to Transport. Amount allocates to Agriculture is multiple of 11.

Q311. In which of the following ministry second-highest amount is allocated?

- (a) Defence
- (b) Agriculture
- (c) Transport
- (d) Health
- (e) None of these

Q312. How much amount allocates in Health ministry?

- (a) 60 Crore
- (b) 70 Crore
- (c) 90 Crore
- (d) 64 Crore
- (e) None of these

Q313. In which of the following ministry 60crore amount are allocated?

- (a) Telecom
- (b) Education
- (c) Defence
- (d) Transport
- (e) None of these

Q314. Difference between the amount allocates in Education and Agriculture ministry?

- (a) 38 Crore
- (b) 45 Crore
- (c) 30 Crore
- (d) 35 Crore
- (e) None of these

Q315. In which of the following ministry lowest amount is allocated?

- (a) Education
- (b) Defence
- (c) Transport
- (d) Agriculture
- (e) None of these

Directions (316-320): Study the information carefully and answer the question given below.

There are eight persons P, Q, R, S, T, U, V and W who lives on an eight-floor building (Ground floor is numbered 1, the floor just above it is numbered as 2 and so on till the topmost floor which is numbered as 8.) but not necessary in the same order. S lives on an odd number floor above 4th floor. There are two persons who live between S and R. V lives on one of the odd numbered floor but not on the bottom most floor. There is one person living between R and P who lives just below T. The total number of persons living between U and Q is same as the total number of persons living between U and P.

Q316. Which of the following floor belongs to U?

- (a) 4th
- (b) 5th
- (c) 7th
- (d) 1st
- (e) 2nd

Q317. How many persons lives between S and R?

- (a) One
- (b) Two
- (c) Three
- (d) Four
- (e) None

Q318. If the position of all the persons are arranged alphabetically from top to bottom then the position of how many persons remain unchanged?

- (a) One
- (b) Two
- (c) Three
- (d) Four
- (e) None

Q319. Four of the following five are alike in a certain way based on their arrangement find the one which does not belong to that group?

- (a) Q
- (b) P
- (c) U
- (d) R
- (e) V

Q320. R is related to P in the way S is related to V, then following the same pattern, U is related to?

- (a) Q
- (b) W
- (c) V
- (d) S
- (e) None of these.

Directions (321-325): Study the following information carefully and answer the question given below:

Seven Students M, N, O, P, Q, R, and S are living on different floors of seven storey building. Ground floor is numbered as 1st and top floor is numbered as 7th floor, also they are of different ages 11, 13, 18, 25, 27, 28, and 30 (not necessarily in same order).

O lives on odd numbered floor but not on topmost floor. S lives one of the even numbered floors below O. There are 2 floors between O and N, who is youngest. Q lives just below N and is 3rd youngest. M lives on even numbered floor and his age is a perfect cube. P doesn't live above N's floor. R is younger than M and older than Q. S's age is a prime number. P is not the oldest.

Q321. Who among the following lives on 4th floor?

- (a) R
- (b) N
- (c) Q
- (d) M
- (e) None of these

Q322. What is the age of O?

- (a) 13
- (b) 27
- (c) 30
- (d) None of these
- (e) 25

Q323. How many persons live between S and N?

- (a) No one
- (b) One
- (c) Two
- (d) Three
- (e) Four

Q324. Who among the following lives on 1st floor?

- (a) P
- (b) O
- (c) M
- (d) S
- (e) None of these

Q325. Who among the following lives just above the one whose age is 25?

- (a) M
- (b) Q
- (c) N
- (d) No one
- (e) None of these

Direction (326-330): Read the information carefully and answer the questions:

There are eight different boxes are places one above another. Each box contains different fruits i.e Mango, Orange, Banana, Apple, Guava, Grapes, Pineapple and Litchi but not necessary in the same order.

The box of orange is immediate above the box of Grapes. The number of boxes in between box of Pineapple and the box of grapes is one more than between the box of Apple and box of Litchi. Not more than three boxes are placed above box of Apple. Two boxes are between box of mango and box of Apple, which is below box of Mango. The box of Guava is immediate above the box of Orange. The box of Mango is adjacent to box of Pineapple. The box of Guava is placed below box of Pineapple.

Q326. How many boxes are between box of Orange and Banana?

- (a) Two
- (b) Three
- (c) One
- (d) Four
- (e) None

Q327. Which Fruit of box is immediate below to box of Guava?

- (a) Apple
- (b) Mango
- (c) Orange
- (d) Litchi
- (e) Grapes

Q328. Four of the following five are alike in certain way based from a group, find the one that does not belong to that group?

- (a) Pineapple, Guava
- (b) Apple, Grapes
- (c) Banana, Orange
- (d) Mango, Pineapple
- (e) Mango, Apple

Q329. Which of the following boxes are not adjacent to each other?

- (a) Pineapple, Mango
- (b) Orange, Grapes
- (c) Apple, Banana
- (d) Orange, Pineapple
- (e) Litchi, Grapes

Q330. Which box is immediate above the box of Banana?

- (a) Orange
- (b) Grapes
- (c) Pineapple
- (d) Guava
- (e) Litchi

Directions (331-335): Study the following information carefully and answer the questions which follow.

Eight persons was born in different months starting from March to October of the same year. Only three persons was born in between S and P, who was born in the month which have odd number of days but not in October. More than three persons were born in between R and T, who was born in the month which have even number of days. T is older than S. Q was born in the month which have 30 days. Two persons was born in U and Q. U is younger than W who was born after V.

Q331. Who among the following person was born in May?

- (a) P
- (b) V
- (c) W
- (d) U
- (e) None of these

Q332. W was born in which of the following month?

- (a) March
- (b) April
- (c) May
- (d) August
- (e) None of these

Q333. How many persons was born in between U and P?

- (a) Two
- (b) Three
- (c) More than Four
- (d) Four
- (e) None

Q334. Which of the following statement is true about T?

- (a) T was born in March
- (b) T was born just after P
- (c) W was born immediate after T
- (d) Only two persons were born between T and the one who was born just before W
- (e) Both (b) and (d)

Q335. Who among the following person is the third youngest person?

- (a) W
- (b) U
- (c) V
- (d) Q
- (e) None of these

Directions (336-340): Study the given information and answer the questions:

Eight friends A, B, C, D, E, F, G and H are sitting around a square table in such a way that four of them sit at the four corners while four sits at the middle of each of four sides. The one who sit at the corners face the center and who sit at the middle of the sides face outwards but not necessarily in the same order. F sits third to left of C. C faces outward. H sits immediate right of A. F sits second to right of B. E sits on the immediate left of A. D is not immediate neighbor of H. Only two friends sit between F and A.

Q336. Who among the following sits at corner of the table?

- (a) C
- (b) D
- (c) G
- (d) B
- (e) None of these

Q337. Who among the following sits opposite to D?

- (a) G
- (b) F
- (c) C
- (d) B
- (e) A

Q338. Who among the following sits immediate left of B?

- (a) A
- (b) E
- (c) C
- (d) B
- (e) None of these

Q339. Who among the following sits 2nd to the left of G?

- (a) A
- (b) H
- (c) B
- (d) E
- (e) F

Q340. Who among following sits diagonally opposite to H?

- (a) E
- (b) B
- (c) F
- (d) A
- (e) None of these

Directions (341-345): Study the following information carefully and answer the questions given below- Eight persons P, Q, R, S, T, U, V and W. They live on a separate floor each of an eight-floor building but not necessarily in the same order. The ground floor is numbered 1 and so on until the topmost floor is numbered 8.

U lives in an odd numbered floor. Four persons live between T and S who lives one of the floor below the floor on which U lives but not immediate below. R lives on the floor numbered which is multiple of 2 but not on 6th floor. V lives on an even numbered floor. More than two persons live between V and S. Q lives immediate above the floor on which W lives. R does not live below U. P lives on an odd numbered floor below T.

Q341. Who lives on the floor just above V?

- (a) U
- (b) P
- (c) No one
- (d) R
- (e) T

Q342. How many persons live between S and V?

- (a) None
- (b) One
- (c) Five
- (d) Three
- (e) Four

Q343. Which of the following pairs live on the first floor and the topmost floor respectively?

- (a) R, Q
- (b) P, R
- (c) U, V
- (d) S, P
- (e) V, R

Q344. Who among the following lives on the fourth floor?

- (a) Q
- (b) S
- (c) P
- (d) T
- (e) V

Q345. Which of the following combination is true?

- (a) First floor-S
- (b) Fourth floor-T
- (c) Third floor-W
- (d) Sixth floor- R
- (e) Second floor- P

Directions (346-350): Study the following information carefully and answer the given questions.

Seven scientist A, B, C, D, E, F and G belongs to different country Japan, France, Russia, Australia, China, India and Germany but not necessarily in the same order. They are living on a seventh-floor building, lowermost floor is numbered as 1 and topmost floor is numbered as 7. D lives on fourth floor but he neither belongs to China nor Australia. F belongs to Japan and he lives either sixth or third floor. C lives on first floor. E belongs to Germany. B does not live on seventh floor. The one who belongs to Australia lives on second floor. F does not live immediate below G. A lives on fifth floor and he belongs to India. The one who belongs France lives on floor Seventh floor.

Q346. Who among the following lives immediate below F?

- (a) the one who belongs to china
- (b) G
- (c) D
- (d) the one who belongs to Australia
- (e) C

Q347. How many persons live in between G and the one who belongs to Russia?

- (a) Four
- (b) One
- (c) Two
- (d) Three
- (e) No one

Q348. Who among the following lives exactly between A and C?

- (a) F
- (b) G
- (c) D
- (d) B
- (e) E

Q349. How many persons live below the one who belong to Germany?

- (a) None
- (b) Two
- (c) Three
- (d) More than three
- (e) One

Q350. Who among the following belongs to France?

- (a) E
- (b) G
- (c) B
- (d) C
- (e) D

Direction (351-355): Read the given information carefully and answer the questions:

Six boxes A, B, C, D, E, and F are placed one above another and contain different items i.e. Flower, Books, Chocolate, Fruit, Watches, and Toy (but not necessarily in the same order). A is placed either top or bottom. Box of watch is placed at bottom. Only one box is placed between D and F. Two boxes are placed between A and D which contain fruit. Box C is placed below E but not just below E. Box of Toy is placed between D and F. The box which is placed just above B is contain books. Box of Chocolate is not placed at top. Box of Chocolate is not placed adjacent to A. Box E is not placed just above and below D. Box F does not contain Flower.

Q351. Which item is containing in Box C?

- (a) Watches
- (b) Books
- (c) Fruit
- (d) Toy
- (e) Flower

Q352. Which of the following box is placed at second to the top?

- (a) B
- (b) F
- (c) E
- (d) A
- (e) C

Q353. How many boxes are placed between E and F?

- (a) One
- (b) Three
- (c) Two
- (d) More than three
- (e) None

Q354. Which box is placed just above box which contain books?

- (a) C
- (b) D
- (c) A
- (d) F
- (e) None of these

Q355. Box F contain which of the following item?

- (a) Watches
- (b) Books
- (c) Fruit
- (d) Toy
- (e) None of these

Directions (356-360): Study the following information carefully and answer the question given below: Eight persons M, N, O, V, W, X, Y and Z attend Meetings on different months of the year viz. January, February, March and April, such that not more than two persons attend their Meetings in each of the months. Meetings can be held on either 10th or 11th day of the month. No two Meetings can be held on the same day. W attend meeting in a month which has less than 30 days. Only one person attend meeting between W and Z. O attends meeting in March. M attend meeting on even day of a month having 30 days. Equal Number of meeting are between Z and X as there between Z and V. Y attend meeting immediate before X.

Q356. M attends his Meeting on which of the following dates?

- (a) 10th March
- (b) 11th April
- (c) 10th April
- (d) 10th January
- (e) None of these

Q357. Which of the following persons attends his Meeting on 11th January?

- (a) W
- (b) N
- (c) M
- (d) X
- (e) None of these

Q358. How many persons attend the Meeting after W?

- (a) 5
- (b) 4
- (c) 6
- (d) 3
- (e) None of these

Q359. Who among the following persons attends the Meeting on 10th March?

- (a) W
- (b) M
- (c) V
- (d) Z
- (e) None of these

Q360. How many persons attended Meeting after V?

- (a) 5
- (b) 4
- (c) 7
- (d) No one
- (e) None of these

Directions (361-365): Study the following information to answer the given questions:

A certain number of persons are standing in a row facing north. Q stands at one of the ends of the row. As many persons are standing between R and T as between S and R. Eight persons are standing between S and P. Only one person stands between Q and S. P is 3rd from one of the ends. L is 5th to the left of R. More than 6 persons are standing between Q and T. Not more than 5 persons are standing between P and L.

Q361. How many persons are standing to the right of L?

- (a) 12
- (b) 9
- (c) 10
- (d) 11
- (e) None of these

Q362. If X is 4th right to T, then how many persons are standing between P and X?

- (a) 3
- (b) 4
- (c) 6
- (d) 5
- (e) None of these

Q363. How many total numbers of persons are standing in the row?

- (a) 15
- (b) 14
- (c) 13
- (d) 12
- (e) None of these

Q364. How many persons are standing between P and R?

- (a) Four
- (b) Three
- (c) Five
- (d) Seven
- (e) Six

Q365. If 'O' is third to the left of L, then what is the position of O with respect to P?

- (a) Second to the right
- (b) Immediate right
- (c) Second to the left
- (d) Third to the left
- (e) Immediate left

Directions (366-370): Study the following information carefully and answer the questions given below: Eight persons are sitting around a square table such that two persons sit on each side of the table (facing center). Each of them either have 9 or 10 toffees. B who has 10 toffees sits 4th left to A. None of the persons having 9 toffees sit together. Not more than one person sit between H and E. Not less than three persons have same number of toffees. F faces C and both have same toffees as A. Only one person sit between F and G. G is not neighbor of B. D has odd number of toffees and sits 2nd to the right of A. E is not 3rd right to A. Two persons sit between B and H.

Q366. Who among the following has 9 toffees?

- (a) E
- (b) F
- (c) C
- (d) B
- (e) None of these

Q367. Who sit 4th left to the one who is immediate right to B?

- (a) E
- (b) F
- (c) C
- (d) B
- (e) None of these

Q368. How many persons sit between D and E, when counted from right of D?

- (a) Two
- (b) One
- (c) Three
- (d) Four
- (e) None of these

Q369. Who among the following sit immediate right to A?

- (a) E
- (b) F
- (c) C
- (d) B
- (e) None of these

Q370. Four of the following belongs to a group find the one that does not belong to that group?

- (a) E
- (b) F
- (c) C
- (d) B
- (e) G

Direction (371-375): Study the following information carefully and answer the questions given below: Eight persons M, N, O, P, Q, R, S and T are sitting around a circular table but not necessarily in the same order. Four of them are facing towards the center while rests are facing outside from the center of the table.

There are two persons sit between R and S and both are facing opposite direction to each other. P sits immediate to the right of R. Both O and Q are immediate neighbors to each other and facing in the same direction. Both P and S are not the immediate neighbors of both O and Q. Both O and N are facing to each other. T sits 3rd to the left of M, who does not sit opposite to S.

Q371. How many persons sit between Q and N, when counting from right of N?

- (a) One
- (b) None
- (c) Two
- (d) Three
- (e) More than three

Q372. Who among the following sits opposite to M?

- (a) O
- (b) T
- (c) P
- (d) R
- (e) N

Q373. Four of the following five are alike in a certain way and hence they form a group. Which one of the following does not belong to that group?

- (a) Q, R
- (b) O, N
- (c) N, Q
- (d) O, P
- (e) R, S

Q374. What is the position of T with respect to P?

- (a) 2nd to the right
- (b) 2nd to the left
- (c) Immediate to the right
- (d) 3rd to the left
- (e) 3rd to the right

375. If the number of persons sit between O and R, when counted to the left of O is same as the number of persons sit between ___ and M, when counted to the left of ___?

- (a) S
- (b) Q
- (c) R
- (d) P
- (e) N

Directions (376-380): Study the following information carefully and answer the questions given below: Eight persons are sitting around a square table in such a way that four person sit at the corner of the table and other four persons sit at the middle of the table. The persons who sit at the corner are facing towards the center and the one who are sitting at the middle are facing away from the center. Ana sits second to the right of Danny. Fredrick sits immediate right of Bony who does not sit at the corner. Garry sits second to the left of Emma who sits at the middle of the table. Two persons sit between Danny and Charlie. Henry is an immediate neighbor of Charlie.

Q376. Who among the following sits second to the left of the person who is third to the right of Garry?

- (a) Fredrick
- (b) Danny
- (c) Charlie
- (d) Henry
- (e) None of these

Q377. Four of the following five are alike in a certain way and hence form a group, which of the following does not belong to the group?

- (a) Henry
- (b) Garry
- (c) Fredrick
- (d) Danny
- (e) Ana

Q378. Number of persons sitting between Charlie and Ana when counting from right of Ana is same as the number of persons sitting between Bony and _____ when counting from right of _____?

- (a) Garry
- (b) Emma
- (c) Fredrick
- (d) Henry
- (e) Danny

Q379. Which of the following is not true?

- (a) Charlie sits second to the left of Garry
- (b) Emma sits immediate right of Danny
- (c) Fredrick faces Ana
- (d) Bony faces outside of the table
- (e) All are true

Q380. How many persons are sitting between Emma and Henry when counting from the left of Emma?

- (a) One
- (b) None
- (c) Three
- (d) Two
- (e) More than three

Direction (381-385): Study the following information carefully and answer the questions given below: Nine people viz. P1, P2, P3, P4, P5, P6, P7, P8 and P9 live in a building on nine different floors. The ground floor is numbered 1, the floor just above it is numbered 2 and so on till top floor which is numbered as 9 (but not necessarily in the same order). More than four persons are living above P4. Three persons are living between P6 and P1 who is living below P8. P2 lives immediately above P9 and immediately below P8. P3 lives below P4 and above P5. Only one person is living between P5 and P7.

Q381. Which of the following is true regarding P1?

- (a) Three persons are living below P1
- (b) Only One person is living between P1 and P9
- (c) P1 is living on an even numbered floor
- (d) All are true
- (e) Four persons are living above P1

Q382. Four of the following five are alike in a certain way and hence form a group, which of the following does not belong to the group?

- (a) P6-P8
- (b) P1-P9
- (c) P4-P7
- (d) P2-P9
- (e) P3-P5

Q383. Who among the following is living on the topmost floor?

- (a) P1
- (b) P6
- (c) P9
- (d) P8
- (e) None of these

Q384. How many persons are living between P4 and P5?

- (a) Two
- (b) Three
- (c) One
- (d) More than four
- (e) Four

Q385. Number of persons living above P8 is same as the number of persons living below _____?

- (a) P4
- (b) P2
- (c) P1
- (d) P3
- (e) None of these

Directions (386-390): Study the information carefully and answer the questions given below:

Seven persons are going to participate in quiz contest in seven different months starting from March to September. D goes in the month which have even numbers of days. More than three persons are going in between D and C. Only two persons going in between F and C. E goes after G, who does not go in March. Three persons are going in between A and B. A does not go after C. More than one-month gap between A and F going for the quiz.

Q386. Who among the following person goes in April?

- (a) E
- (b) D
- (c) A
- (d) B
- (e) None of these

Q387. Who among the following person are going immediate after the month in which E goes?

- (a) B
- (b) D
- (c) G
- (d) C
- (e) None of these

Q388. Four of the following are alike in a certain way so form a group, which among the following does not belong to that group?

- (a) E
- (b) A
- (c) F
- (d) B
- (e) None of these

Q389. Which of the following statement is true about C?

- (a) C goes before F
- (b) Only three persons go between C and G
- (c) G goes just before C
- (d) C goes in September
- (e) Both (b) and (d)

Q390. How many persons are going in between G and B?

- (a) Two
- (b) One
- (c) Three
- (d) More than Three
- (e) None

Directions (391-395): Read the given information carefully and answer the questions:

Twelve Persons are sitting in two parallel rows -A, B, C, D, E and F are sitting in row 1 facing south and I, G, K, L, M and N are sitting in row 2 facing north. Therefore in the given seating arrangement each member seated in a row faces another member of the other row. L sits third to the left of I. F does not face I. Neither L nor I sits at extreme ends. G sits at one of the extreme ends. Only two people sit between G and M. F is not an immediate neighbor of E. M does not face F. Two persons sit between B and C. F does not sit at any of the extreme ends. E faces L. C is not an immediate neighbor of E. A does not face I. K sits left of N.

Q391. Who among the following sits diagonally opposite to C?

- (a) G
- (b) F
- (c) K
- (d) I
- (e) None of these

Q392. Who among the following sits third to the left of E?

- (a) D
- (b) F
- (c) A
- (d) C
- (e) None of these

Q393. Who among the following faces M?

- (a) A
- (b) F
- (c) C
- (d) B
- (e) E

Q394. Four of the following five form a group, which among the following does not belong to this group?

- (a) G, F
- (b) N, E
- (c) M, A
- (d) I, B
- (e) L, A

Q395. How many persons sit between N and K?

- (a) Three
- (b) Two
- (c) None
- (d) One
- (e) More than Three

Direction (396-400): Study the given information carefully and answer the questions that follow:

Eight friends A, B, C, D, E, F, G and H sits around a circular table in such a way that four of them face opposite to the center while rest face towards the center.

G and C face same direction but opposite to D and B. D sits third to the left of H, who sits third to the right of B. G sits third to the right of F. A sits opposite to D. E sits opposite to C, who is not an immediate neighbor of B. F doesn't face outside. D is not an immediate neighbor of F. A faces towards the center. Not more than two persons sit together facing same direction.

Q396. How many people sit between H and D when counted from the right of H?

- (a) None
- (b) Four
- (c) One
- (d) Three
- (e) Two

Q397. Which of the following is true regarding A?

- (a) Both F and E are immediate neighbors of A
- (b) Only three people sit between A and G.
- (c) A faces outside
- (d) F sits second to the right of A
- (e) None of the given options is true.

Q398. What is the position of C with respect to G?

- (a) Second to the left
- (b) Third to the left
- (c) Second to the right
- (d) Fifth to the right
- (e) Fifth to the left.

Q399. Four of the following five are alike in a certain way and so form a group. What is the one that does not belong to that group?

- (a) B
- (b) C
- (c) H
- (d) E
- (e) G

Q400. Who sits second to the left of F?

- (a) G
- (b) B
- (c) D
- (d) A
- (e) None of these

Directions (401-405): Study the information carefully and answer the questions given below.

A person starts walking from point B in east direction and walks 7m to reach point V. From point V, he takes a right turn and walks 5m to reach point X. From point X, he starts walking in 9m north to reach at point K. From point K, He takes a left turn and walks 12m to reach point Z. From point Z, he starts walks 8m in south direction to reach at point P. Now he takes left turn and walks 6m to reach point A.

Q401. If point G is north of point A and east of point Z, then what is the shortest distance between point G and point K?

- (a) 5m
- (b) 7m
- (c) 6m
- (d) 4m
- (e) None of these

Q402. In which direction point A with respect to point B?

- (a) South
- (b) North
- (c) South-west
- (d) South-east
- (e) None of these

Q403. What is the shortest distance between Point K and Point A?

- (a) 10m
- (b) 9m
- (c) 6m
- (d) 11m
- (e) None of these

Q404. In which direction point P with respect to point X?

- (a) North-west
- (b) North-east
- (c) South
- (d) North
- (e) None of these

Q405. If point S is midpoint between point Z and point P then in which direction point V with respect to point S?

- (a) North-east
- (b) South-east
- (c) West
- (d) East
- (e) South

Directions (406-407): Study the following information carefully and answer the questions given below: There are seven family members P, Q, R, S, U, V and W. There are two married couples. Q is the brother in law of V and son of R. W is the sister in law of P. R is grandfather of S. U is brother of S. R has two child and only one son. W is mother of S, who is niece of P. P is the wife of V.

Q406. How is P related to S?

- (a) Uncle
- (b) Aunt
- (c) Daughter
- (d) Daughter in law
- (e) Can't be determined

Q407. If M is the son of P then how is M related to S?

- (a) Cousin
- (b) Brother
- (c) Sister
- (d) Brother in law
- (e) None of these

Direction (408-409): Study the following information carefully and answer the questions given below: In a family of seven people, there are two couples and three generations. G is the grandchild of B. B is married to A. E is the father of G. A is father in law of F. E is brother of D and C. C is uncle of G.

Q408. How is D related to G?

- (a) Father
- (b) Uncle
- (c) Aunt
- (d) Mother
- (e) can't be determined

Q409. How is A related to C?

- (a) Father
- (b) Mother
- (c) Grandfather
- (d) father in law
- (e) None of these

Q410. There are two couples in a five membered family. R is grand parent of S who is the son of T. U is the daughter in law of V. S is an unmarried member in the family. How is V related to T?

- (a) Mother
- (b) Father
- (c) Son
- (d) Daughter
- (e) Can't be determined

Directions (411-413): Study the information carefully and answer the questions given below.

Eight persons are in three generation of family and two married couple. P is son in law of H, who has three children. M is nephew of L. W is father of K, who is sister in law of U. U is only daughter of H, who is father of N. L is unmarried. N and K don't have any child.

Q411. Who among the following is son in law of W?

- (a) U
- (b) P
- (c) N
- (d) K
- (e) None of these

Q412. Who among the following is sister of N?

- (a) P
- (b) U
- (c) K
- (d) N
- (e) None of these

Q413. How many male members in the family?

- (a) Four
- (b) Five
- (c) Three
- (d) Six
- (e) Two

Q414. Pointing towards a girl, lady said "This girl is daughter of the only daughter of my son's father in law". How is girl related to that lady?

- (a) Grandmother
- (b) Mother
- (c) Sister
- (d) Granddaughter
- (e) None of these

Q415. A person starts walking in north direction and walk 5m to reach at point H and from point H, he take two consecutive right turn of 6m and 8m respectively to reach point G. Now he walks 4m in east direction and reach at point L. What is the shortest distance between starting point and L?

- (a) $\sqrt{44}$ m
- (b) 7m
- (c) 8m
- (d) $3\sqrt{5}$ m
- (e) None of these

Directions (416-420): In these questions, relationship between different elements is shown in the statements. These statements are followed by two conclusions.

Mark answer as

- (a) If only conclusion I follows.
- (b) If only conclusion II follows.
- (c) If either conclusion I or II follows.
- (d) If neither conclusion I nor II follows.
- (e) If both conclusions I and II follow.

Q416. Statements: $A = F, W \geq D < M < P < A$

Conclusions:

- I. $D > F$
- II. $A > W$

Q417. Statements: $S < B, H \geq J > F < Q = B$

Conclusions:

- I. $Q > S$
- II. $F > B$

Q418. Statements: $M > T > Q > Z = J$

Conclusions:

- I. $Q \geq J$
- II. $T > J$

Q419. Statements: $S = B > Q, C < A < Q$

Conclusions:

- I. $B > A$
- II. $S > C$

Q420. Statements: $Q \geq R < D = Z > A > T$

Conclusions:

- I. $R \geq A$
- II. $A < R$

Directions (421-424): Study the information carefully and answer the questions given below.

Ankur starts his journey from point T, walks 8m towards East to reached at point P, then takes a right turn and walks for 15m to reach point X. From point X he takes a left turn and walks for 7m to reach at point S, from point S, he takes a right turn and walks 14m to reach at point J, then takes a right turn and walks 18m to reach point O. From point O, He walks 14m in north direction and reached point H.

Q421. What is the shortest distance between point T and X?

- (a) 15m
- (b) 19m
- (c) 15m
- (d) 17m
- (e) None of these

Q422. In which direction point T with respect of H?

- (a) North
- (b) North-east
- (c) South-west
- (d) South
- (e) North-west

Q423. If point M is 9m south of Point S, what is the shortest distance between point R and M?

- (a) 26m
- (b) 22m
- (c) 21m
- (d) 24m
- (e) 25m

Q424. What is the total distance covered by Ankur from point T to point H?

- (a) 76m
- (b) 65m
- (c) 68m
- (d) 74m
- (e) 75m

Q425. Pointing to a lady, Dinesh says to his only Brother, "She is daughter of my mother's only daughter in law". Dinesh's brother is unmarried. How is the lady related to Dinesh?

- (a) Brother
- (b) Daughter-in-law
- (c) Sister
- (d) Daughter
- (e) Wife

Directions (426-430): In each of the questions below are given some statements followed by some Conclusions. You have to take the given statements to be true even, if they seem to be at variance from commonly known facts. Read all the conclusions and then decide which of the given conclusions logically follows from the given statements disregarding commonly known facts.

- (a) If only conclusion I follows.
- (b) If only conclusion II follows.
- (c) If either conclusion I or II follows.
- (d) If neither conclusion I nor II follows.
- (e) If both conclusions I and II follow.

Q426. Statements:

Some Noise are steel
No steel is Blood
Some steel is Free

Conclusion:

- I: Some noise are not Blood
- II: All Blood is noise

Q427. Statements:

All Voice are World
No Colour is Daily
All Daily are world

Conclusion:

- I: All colour can be Voice
- II: All Voice can be daily

Q428. Statements:

Only a few Floor is Box
Some box are Square
Only Square is Month

Conclusions:

- I. Some Box can be month
- II. All floor can be Box

Q429. Statements:

All Pause are Stop
Only a few Stop are Play
No Resume is play

Conclusions:

- I. All Stop can never be Resume
- II. Some pause can be Play

Q430. Statements:

Only water is steam

Only a few water is Glass

All Shop are glass

Conclusions:

I: Some water is shop

II: No shop is water

Directions (431-435): Study the following information carefully and answer the questions which follow.

Eight persons are sitting around a circular table, facing towards inside. Each of them likes different colours- Red, White, Black, Yellow, Green, Brown, Pink and Blue.

S likes pink and sits second to the right of M. The one who likes black sits second to the right of the one who likes green. The one who likes brown sits opposite to S. T likes blue and he is not an immediate neighbour of M and S. The one who likes white sits second to the left of Q. O sits second to the left of T. R and N are immediate neighbours of each other. P sits second to the left of R. P sits opposite to the one who likes red. Q doesn't like yellow and black.

Q431. Who among the following likes Green colour?

- (a) N
- (b) Q
- (c) O
- (d) P
- (e) None of these

Q432. Who among the following sits second to the left of the one who likes white colour?

- (a) The one who likes Yellow colour
- (b) O
- (c) The one who likes Blue colour
- (d) S
- (e) None of these

Q433. P likes which of the following colour?

- (a) Green
- (b) White
- (c) Black
- (d) Yellow
- (e) None of these

Q434. Which of the following statement is true about O?

- (a) O likes Green colour
- (b) T sits second to the left of O
- (c) O sits opposite to T
- (d) O likes Black colour
- (e) None is true

Q435. Who among the following sits opposite to the one who likes yellow colour?

- (a) M
- (b) O
- (c) T
- (d) N
- (e) None of these

Q436. If all the vowels of the word 'TREATMENT' are replaced by its succeeding letter according to the English alphabet and all the consonant are replaced with their previous letter according to the English alphabet and then all the letters are arranged in the alphabetical order, then how many letter are there between the third letter from the left and fourth letter from the right in the English alphabetic series?

- (a) 6
- (b) 12
- (c) 9
- (d) 10
- (e) 11

Q437. Which alphabet is 3rd from the left in the meaningful four-letter word formed from the 1st, 2nd, 5th and 8th letter of the word "JOURNALIST"? If more than one word is formed, then mark answer as X and no meaningful word is formed then mark answer as Z.

- (a) O
- (b) J
- (c) Z
- (d) I
- (e) X

Q438. If in the number "364872159", 2 is multiply by the digits which is less than 5 and 1 is subtracted to the digits which is greater than 4, then all digits are arranged in ascending order from left to right, then which of the following digit is exactly middle in the number?

- (a) 7
- (b) 6
- (c) 5
- (d) 4
- (e) None of these

Q439 Which of the following elements should come in a place '?' ?

DW2 GT4 JQ16 ?

- (a) LO 30
- (b) NM 8
- (c) MO 231
- (d) MN256
- (e) None of these

Q440. How many pairs of letters (both forward and backward direction) are there in the word "LANDSCAPE" each of which have as many letters between them in the word as they have between them in the English alphabetical series?

- (a) One
- (b) More than Three
- (c) Three
- (d) Two
- (e) None

Directions (441-445): These questions are based on the following arrangement. Study the arrangement carefully to answer these questions.

T 3 H 1 # U N 9 B S = 6 Z \$ R 2 K * C M V @ 7 D O E % L 8 G P A

Q441. How many such symbols are there in the above arrangement, each of which is immediately followed by a vowel?

- (a) One
- (b) Two
- (c) Three
- (d) More than Three
- (e) None

Q442. Which of the following element is exactly in the middle of 7th element from the right end and the 10th element from the left end of the arrangement?

- (a) K
- (b) C
- (c) M
- (d) *
- (e) None of these

Q443. How many such symbols are there in the above arrangement, each of which is immediately preceded by a number and also immediately followed by a consonant?

- (a) One
- (b) None
- (c) Two
- (d) Three
- (e) More than three

Q444. How many such vowels are there in the above arrangement each of which is immediately followed by a number and also immediately preceded by a consonant?

- (a) None
- (b) One
- (c) Two
- (d) Three
- (e) None of these

Q445. What should come in the place of question mark (?) in the following series based on above arrangement?

H#T B=N RKZ ?

- (a) VC@
- (b) 7D@
- (c) D%7
- (d) V7C
- (e) None of these

Directions (446-450): Study the information carefully and answer the questions given below.

Eight persons J, K, L, M, N, O, P and Q are sitting in a linear row some of them facing towards the north and some of them facing towards south but not necessary in the same order. Not more than two consecutive persons face same direction.

N sits second to the right of J. Q sits second to the left of N. Two persons sit between Q and P. More than three persons sit between L and O. The persons sit on extreme ends face opposite direction to each other. M sits second to the right of P. N is not immediate neighbor of M, who sits third from one of the extreme ends of row. O is not immediate neighbor of N and M. O face south direction. J sits immediate right of M. L face opposite direction to Q.

Q446. Who among the following person sits second to right of O?

- (a) M
- (b) P
- (c) J
- (d) K
- (e) None of these

Q447. How many persons sits between N and K?

- (a) One
- (b) Two
- (c) Four
- (d) Three
- (e) None of these

Q448. Who among the following person is immediate neighbor of P and J?

- (a) L
- (b) M
- (c) K
- (d) Q
- (e) None of these

Q449. How many persons sits on the right of M?

- (a) One
- (b) More than Four
- (c) Three
- (d) Four
- (e) None

Q450. Four of the following five are alike in certain way based from a group, find the one that does not belong to that group?

- (a) Q
- (b) N
- (c) K
- (d) J
- (e) P

Q451. How many pairs of letters are there in the word "POTENTIALLY" each of which have as many letters between them in the word as they have between them in the English alphabetical series?

- (a) One
- (b) Two
- (c) Three
- (d) Four
- (e) More than Four

Q452. How many words can be formed from the 1st, 5th, 8th and 9th letter of a word 'ASTONOMERS' by using each letter once in the word?

- (a) two
- (b) one
- (c) none
- (d) three
- (e) more than three

Q453. If all the letters in the word DELIGHT are arranged in alphabetical order from left to right in such a way that vowels are arranged first followed by consonants, then how many letters are there in between D and L after the arrangement?

- (a) two
- (b) one
- (c) none
- (d) three
- (e) four

Q454. Payal is 21th from the left end of a row of 47 students and Neetu is 23th from the right end in the same row. How many students are there between them in the row?

- (a) 4
- (b) 1
- (c) 3
- (d) 5
- (e) None of these

Q455. Kamalpreet ranked 13th from the top and 34th from the bottom in a class. How many students are there in the class?

- (a) 47
- (b) 46
- (c) 39
- (d) 49
- (e) 45

Directions (456-460): Study the following information carefully and answer the question given below.

Eight friends are sitting in a straight line. Some of them face north while some of them face south direction. R who sits one of the extreme end, sits third to the right of S. Y sits second to the right of V. Only three persons sit between W and Y who does not sit at extreme end of the row. V sits third to the left of U who is an immediate neighbour of W. V does not face south. T sits second to the left of X who sits third to the right of W. R sits left of T and facing opposite direction of T. Y faces north direction.

Q456. Who amongst the following sits exactly between W and Y?

- (a) S
- (b) R
- (c) V
- (d) X
- (e) T

Q457. Who amongst the following sits third to the left of Y?

- (a) S
- (b) T
- (c) U
- (d) V
- (e) W

Q458. Four of the following five are alike in a certain way and so form a group, which among the following does not belong to that group?

- (a) R
- (b) S
- (c) X
- (d) Y
- (e) U

Q459. How many people sit between Y and U?

- (a) Four
- (b) Three
- (c) None
- (d) Two
- (e) One

Q460. Who among the following sits fourth to the right of one who sits immediate right of V?

- (a) W
- (b) U
- (c) X
- (d) T
- (e) Y

Directions (461-465): Study the information carefully and answer the questions given below.

Eight persons X, Y, Z, A, B, C, J and K attend lectures on two different dates 17th and 28th of four different months viz. January, February, March and April of the same year.

J attend lecture on an even date before X. Two persons attend lecture between X and Y. Z attends lecture before C. K attends lecture after Y. X attends lecture in the month which has least number of days.

Three persons attend lecture between Z and C. Z does not attends lecture on an even number date. B does not attend lecture in the month having least number of days. Y does not attend lecture before B.

Q461. How many persons attends lecture between X and C?

- (a) One
- (b) Two
- (c) Three
- (d) Four
- (e) No one

Q462. Who among the following attends lecture on 28th March?

- (a) Y
- (b) B
- (c) K
- (d) X
- (e) Z

Q463. Who among the following attends lecture immediately after X?

- (a) C
- (b) A
- (c) B
- (d) Z
- (e) None of these

Q464. Four among the following five belongs to a group. Who does not belong to the group?

- (a) J
- (b) X
- (c) A
- (d) B
- (e) K

Q465. Who among the following attends lecture on 17th of April?

- (a) Y
- (b) K
- (c) Z
- (d) A
- (e) B

Directions (466-470): Study the information carefully and answer the questions given below.

Eight persons are sitting in a circular table. Some of them face towards center and some of them face outside the center.

X sits second to the right of T. S sits second to the right of X. The person who sits immediate left of T sits opposite to the one who sits second to the left of R. R is not immediate neighbor of S. Z sits opposite to P. Q is not immediate neighbor of P and S. Y face same direction as Q. Y face opposite direction as S. S, P and Z face same direction. Not more than three person face outside the center.

Q466. Who among the following sits immediate right of Y?

- (a) Q
- (b) S
- (c) P
- (d) Z
- (e) None of these

Q467. Which of the following group of persons face outside the center?

- (a) Q, Y, R
- (b) R, Q, T
- (c) T, X, P
- (d) S, P, Z
- (e) None of these

Q468. Four of the following five are alike in certain way based from a group, find the one that does not belong to that group?

- (a) T
- (b) R
- (c) X
- (d) P
- (e) S

Q469. Which of the following person sits second to the right of one who sits opposite to T?

- (a) Y
- (b) X
- (c) Q
- (d) R
- (e) None of these

Q470. How is R related to Z?

- (a) Second to the right
- (b) Second to the left
- (c) Third to the right
- (d) Second to the right
- (e) None of these

Directions (471-475): Read the following information carefully and answer the given questions:

Seven persons are living in a different floor of a building having seven floors, lowermost floor is numbered as 1 and topmost floor is numbered as 7. They like different colours- Blue, Pink, Black, Purple, Green, Yellow, and White (but not necessarily in the same order). P likes Pink and lives on an even numbered floor but not more than two people live below P. V lives on 5th floor and does not like Yellow. T likes Black and lives on one of the odd numbered floors above the one likes Blue. Q likes Purple. R lives just above U, who likes Green. S likes White and lives below P.

Q471. Who among the following likes Blue?

- (a) Q
- (b) P
- (c) V
- (d) S
- (e) None of these

Q472. Who among the following lives just below the one who likes Yellow?

- (a) U
- (b) S
- (c) The one who likes Green
- (d) Both (a) and (c)
- (e) None of these

Q473. R lives on which of the following floor?

- (a) 3rd
- (b) 4th
- (c) 5th
- (d) 7th
- (e) None of these

Q474. How many persons live between Q and P?

- (a) Three
- (b) Two
- (c) One
- (d) Four
- (e) None of these

Q475. Who among the following lives just above V?

- (a) T
- (b) S
- (c) P
- (d) Q
- (e) None of these

Q476. Rohit ranked 39th from the bottom and 45th from the top among those who passed an exam. Three boys did not participate in the exam and Ten failed in it. How many boys were there in the class?

- (a) 81
- (b) 97
- (c) 96
- (d) 98
- (e) None of these

Q477. How many pairs of letters are there in the word "DOCTRINE" each of which have as many letters between them in the word as they have between them in the English alphabetical series?

- (a) Two
- (b) None
- (c) Three
- (d) More than three
- (e) One

Directions (478-480): Study the information carefully and answer the questions given below.

Seven boxes are placed one above other in a stack. Box D is placed just above box R. Four boxes are placed between Box R and Box K. Box F is placed just above box K. More than one box is placed between F and L. Box B is placed below box M, which is not placed just above or just below box L.

Q478. How many boxes are placed between box M and box R?

- (a) One
- (b) None
- (c) Three
- (d) More than three
- (e) Two

Q479. Which of the following box is placed just above box B?

- (a) L
- (b) M
- (c) D
- (d) K
- (e) None of these

Q480. How many boxes are placed below box D?

- (a) One
- (b) Two
- (c) Three
- (d) Four
- (e) None

Directions (481-485): Study the information carefully and answer the questions given below.

Seven friends A, B, C, D, E, F, and G are playing different sports in the college viz. Football, Hockey, Cricket, Badminton, Volleyball, Tennis, and Baseball on different days of same week from Monday to Sunday, but not necessarily in the same order.

Four friends play the sport between the one who plays Baseball I and A, who does not play sport on Tuesday. Only the one who plays Cricket plays between F and D. The one who plays Badminton plays just after F. B does not play sport on Friday and Sunday and does not play Cricket. E plays sport before B, but not just before. C plays Volleyball. The one who plays Tennis play on Wednesday. The one who plays Football does not play on Saturday. G does not play sport just after the one who plays Badminton. D does not play tennis.

Q481. Who among the following plays sport on Tuesday?

- (a) F
- (b) The one who plays Cricket
- (c) B
- (d) C
- (e) None of these

Q482. On which of the following day B plays?

- (a) Friday
- (b) Sunday
- (c) Tuesday
- (d) Wednesday
- (e) None of these

Q483. Which of the following sport F plays?

- (a) Cricket
- (b) Tennis
- (c) Football
- (d) Baseball
- (e) None of these

Q484. How many friends play sport between E and A?

- (a) Two
- (b) One
- (c) Three
- (d) More than three
- (e) No one

Q485. Which of the following person play Hockey?

- (a) G
- (b) A
- (c) E
- (d) F
- (e) None of these

Directions (486-490): Study the following information carefully and answer the given questions:

Ten persons are sitting in two parallel rows containing 5 person each, in such a way that there is an equal distance between adjacent persons. In row-1 U, W, X, Y and Z are sitting and all of them are facing South. In row-2 F, G, H, J and K are sitting and all of them are facing North. Therefore, each person sits in a row faces another person of other row.

G sits opposite to the one who sits second to the left of the one who sits third to the right of Y. Only one person sits between G and J. X sits second to the right of Z. J faces neither X nor Z. K sits second to the left of H and he does not sit at any of the extreme ends. F is not an immediate neighbour of K. W faces neither K nor J.

Q486. Who among the following sits opposite to U?

- (a) J
- (b) K
- (c) F
- (d) H
- (e) None of these

Q487. Who among the following sits second to the right of W?

- (a) Z
- (b) U
- (c) Y
- (d) X
- (e) None of these

Q488. Four of the following five belong to a group in a certain way, find which of the one does not belong to that group?

- (a) X
- (b) H
- (c) Y
- (d) F
- (e) U

Q489. How many persons sit between K and F?

- (a) None
- (b) Two
- (c) One
- (d) Three
- (e) None of these

Q490. What is the position of H with respect to J?

- (a) Third to the left
- (b) Immediate right
- (c) Second to the left
- (d) Third to the right
- (e) Fourth to the right

Directions (491-495): Study the following information carefully to answer the given questions:

Eight Persons are going to attend seminar on two different dates-13th and 28th of the four different months starting from March to June.

Only three persons attend seminar between V and U, who goes in the month which has even number of days. More than four persons attend seminar after P. Only two persons attend seminar between P and T, who attends on an even number date. V attends seminar immediate after R, but not in the same month. Q and W attend seminar on the same date but in different month. More than one person attend seminar between S and W. U and T don't attend seminar in same month.

Q491. Who among the following attend seminar on 28th May?

- (a) T
- (b) Q
- (c) P
- (d) S
- (e) None of these

Q492. V attends seminar on which of the following month?

- (a) April
- (b) June
- (c) March
- (d) May
- (e) Cannot be determine

Q493. How many persons are going in between R and Q?

- (a) Two
- (b) One
- (c) Three
- (d) More than Three
- (e) None

Q494. Which of the statement is true about W?

- (a) W attends seminar on an odd number date
- (b) W attends seminar on the month which has even number of days
- (c) Only two persons are attending seminar between T and W
- (d) Q attends seminar immediate before W
- (e) None of these

Q495. Four of the following are alike in a certain way so form a group, which among the following does not belong to that group?

- (a) P- 13th March
- (b) Q- 28th May
- (c) U- 13th June
- (d) V- 28th April
- (e) S- 13th May

Directions (496-498): Study the information carefully and answer the questions given below.

Seven persons A, B, C, D, E, F and G are sitting in a circular table. Some of them facing towards center and some of them facing away from center but not necessary in same order.

D sits third to the right of B. E sits immediate left of D. Two persons sit between B and G. A is immediate neighbor of C. A sits third to the right of F. Immediate neighbor of G face opposite direction to each other. G face towards the center. Neither G nor C face same direction as D. Not more than four person face towards center.

Q496. Who among the following person sits second to the right of C?

- (a) F
- (b) D
- (c) E
- (d) G
- (e) None of these

Q497. How many persons sit between A and E, when counted to the right of E?

- (a) Two
- (b) Three
- (c) One
- (d) Four
- (e) None of these

Q498. How many persons face outside the center?

- (a) Four
- (b) Two
- (c) Three
- (d) Five
- (e) None of these

Q499. If all the digits in the number "8154276367" arranged in ascending order from left to right then how many numbers remains same in their position?

- (a) One
- (b) Two
- (c) Three
- (d) Four
- (e) None of these

Q500. If 'A × D' mean 'D is the sister of A', 'A + D' means 'D is the daughter of A', 'A ÷ D' means 'A is the wife of D', and 'A-D' means 'A is brother of D' then how will 'K is mother of P' be denoted?

- (a) $J - K \div P + L$
- (b) $K + P + M \times J$
- (c) $J - K \div L + P$
- (d) $K - J \div L + P$
- (e) None of these

SOLUTIONS

Solutions (1-5):

S1. Ans.(b)

Sol. K 4 F 7 B

S2. Ans.(c)

Sol. J \$ V, Q # 2

S3. Ans.(d)

S4. Ans.(b)

Sol. 3 % 9

S5. Ans.(a)

Solutions (6-10):

S6. Ans.(d)

Sol. IMX KQZ MJK UGJ YOM

S7. Ans.(c)

S8. Ans.(b)

Sol. YPM MJK VGJ JMX KQZ

S9. Ans.(d)

Sol. XOL LIJ UFI ILW JPY

S10. Ans.(c)

Sol. OYM JMK GUJ MIX QKZ

Solutions (11-15):**S11. Ans.(d)****S12. Ans.(a)****Sol.** 378, 678, 167, 258, 127, 379**S13. Ans.(d)****Sol.** 837, 786, 716, 825, 271, 397**S14. Ans.(d)****Sol.** 287, 776, 076, 185, 621, 837**S15. Ans.(c)****Sol.** 4, 9, 2, 5, 8, 5**Solution (16-20):****S16. Ans.(a)****S17. Ans.(e)****S18. Ans.(e)****S19. Ans.(e)****S20. Ans.(a)****Solution (21-25):****S21. Ans.(b)****S22. Ans.(a)****S23. Ans.(b)****Sol.** (O#E, E!A)**S24. Ans.(e)****Sol.** (1IV, 87F, 4&R, 2©B, 7FN)**S25. Ans.(d)**

Solution (26-30):

S26. Ans.(b)

S27. Ans.(b)

S27. Ans.(c)

S29. Ans.(e)

S30. Ans.(d)

Solutions (31-35):

Box
P
O
L
K
M
J
N
Q

S31. Ans.(e)

S32. Ans.(d)

S33. Ans.(d)

S34. Ans.(e)

S35. Ans.(d)

Solutions (36-40):

Floor	Persons
9	U
8	R
7	X
6	S
5	W
4	Q
3	V
2	T
1	P



S36. Ans.(c)

S37. Ans.(b)

S38. Ans.(d)

S39. Ans.(c)

S40. Ans.(e)

S41. Ans.(a)

Sol. TIME, EMIT, ITEM

S42. Ans.(d)

Sol. Original Number- 546839271

Obtained Number- 877664332

Solutions (43-45):

Sol.

Time \ Month	10 AM	3 PM
March	P	S
April	U	Q
May	W	V
June	R	T

S43. Ans.(d)

S44. Ans.(b)

S45. Ans.(c)

Solutions (46-50):

Sol.

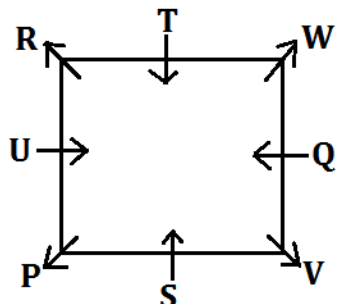

S46. Ans.(e)

S47. Ans.(c)

S48. Ans.(d)

S49. Ans.(b)

S50. Ans.(d)

Solutions (51-15):

Designation	Person
CEO	G
GM	B
DGM	C
AGM	A
Manager	E
Junior Manager	D
Clerk	F

S51. Ans.(e)

S52. Ans.(c)

S53. Ans.(d)

S54. Ans.(a)

S55. Ans.(c)

Solutions (56-60):

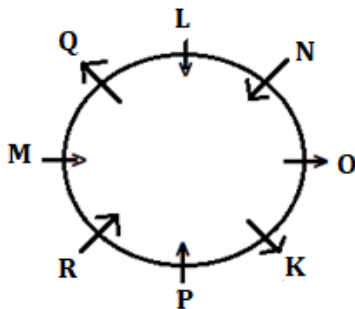

S56. Ans.(a)



S57. Ans.(c)

S58. Ans.(a)

S59. Ans.(d)

S60. Ans.(d)

Solutions (61-65):

Word	Code
Book	fa
Page	vt
Quiz/ latest	ba/sx
Road	lm
Online	mp
Study	qa
update/ practice	ca/ za
Officer	ta

S61. Ans.(e)

S62. Ans.(b)

S63. Ans.(c)

S64. Ans.(b)

S65. Ans.(d)

Solutions (66-70):

Words	Code
Month	tp
Product	pr
Sale	rt
central/ survey	ge/hg
Global	ac
Budget	df
Fear	la
Table	rs

S66. Ans.(c)

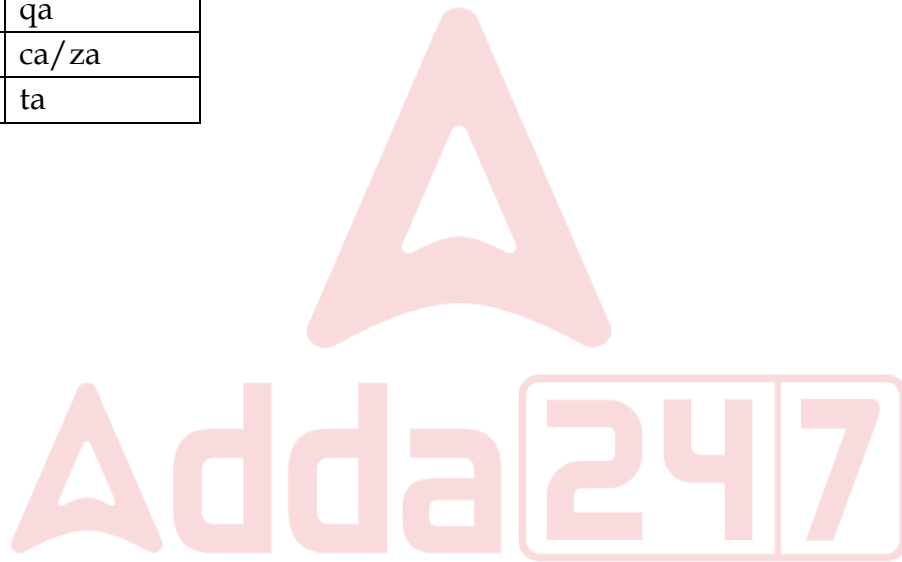

S67. Ans.(a)

S68. Ans.(e)

S69. Ans.(c)

S70. Ans.(c)

Solutions (71-75):

Word	Code
Wealth	st
Create	pk
Secure	lp
Movie	ks
Rural	ir
Money	fu
Coin	gt
Economy	gb
Happy/Replace	xz/lo

S71. Ans.(e)

S72. Ans.(e)

S73. Ans.(b)

S74. Ans.(c)

S75. Ans.(a)

Solutions (76-80):

Word	Code
Certifies	mn
Winner	ie
Health	as
Care	bn
Court	cd
Special	zq
Zone	st
Liberty/result	zx/yx



S76. Ans.(a)

S77. Ans.(d)

S78. Ans.(e)

S79. Ans.(b)

S80. Ans.(d)

Solutions (81-85):

Word	Code
Stone	Xl
Family	Sa
Epic	Hx
Black	Zh
Value	Da
Watch	Dx
Award	Fa
Code	Ha

S81. Ans.(b)

S82. Ans.(a)

S83. Ans.(c)

S84. Ans.(c)

S85. Ans.(d)

Solutions (86-90):

Word	Code
Appeal	fm
Space	xp
Year	fe
Reason	mx
Climate	xe
Society	kx
Fashion	xi
Preview/ Yoga	yh/yz



S86. Ans.(d)

S87. Ans.(c)

S88. Ans.(d)

S89. Ans.(b)

S90. Ans.(d)

Solutions (91-95):

Word	Code
Fact	zi
Case	la
Under	pa
Europe	ta
Winner	sa
Verdict	ga
North/ Roar	na/hi
Sport/ Orange	mi/jo

S91. Ans.(b)

S92. Ans.(e)

S93. Ans.(c)

S94. Ans.(b)

S95. Ans.(a)

Solution (96-100)

Word	Code
Fate	Ka
Red/Mobile	ho/ga
Peace	La
Prepare	mo
And	Pa
Values	Zi
Hero	Ne
Honour	Ta

S96. Ans.(a)



S97. Ans.(d)

S98. Ans.(b)

S99. Ans.(a)

S100. Ans.(e)

Solutions (101-105):

Box	Items
E	Chips
G	Burger
L	Biscuit
O	Samosa
F	Pastry
K	Chocolate
H	Momos

S101. Ans.(b)

S102. Ans.(b)

S103. Ans.(d)

S104. Ans.(c)

S105. Ans.(b)

Solutions (106-110):

Person	Place	Mobile
J	Agra	Vivo
K	Surat	Mi
L	Rewari	Samsung
M	Jaipur	Nokia
N	Noida	Oppo
O	Gurgaon	Apple
P	Delhi	Oneplus

S106. Ans.(e)

S107. Ans.(c)



S108. Ans.(e)

S109. Ans.(c)

S110. Ans.(d)

Solutions (111-115):

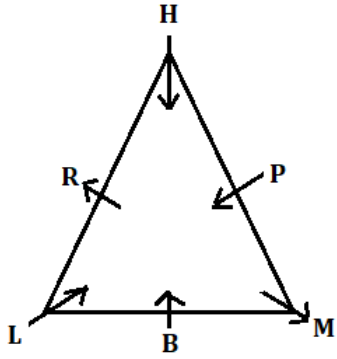

S111. Ans.(a)

S112. Ans.(c)

S113. Ans.(e)

S114. Ans.(c)

S115. Ans.(e)

Solutions (116-120):

Month	Person
January	P
March	N
April	M
May	K
June	J
July	L
August	O

S116. Ans.(d)

S117. Ans.(b)

S118. Ans.(c)

S119. Ans.(d)

S120. Ans.(e)

S121. Ans.(c)

Sol. Original Word- MEMORIZE
After operation- EEIOMMRZ

S122. Ans.(e)

Sol. Original word- FIRECRACKER
Obtained word-ACCEEFIKRRR

S123 Ans.(d)

Sol.

PREDICTION

S124. Ans.(c)

Sol.

SCRABBLE
BSDTFMCC

S125. Ans.(d)

Original no.- 463965812
Obtained no.-333455667

Solutions (126-128):

$K > O(25) > J > M > N > L$

S15. Ans.(c)

S16. Ans.(d)

S17. Ans.(b)

Solutions (129-130):

S129. Ans.(a)

S130. Ans.(a)



Solutions (131-135):

S131. Ans.(c)

Sol.



S132. Ans.(d)

Sol.



S133. Ans.(a)

Sol.

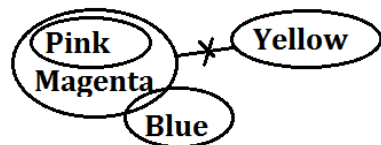

S134. Ans.(d)

Sol.

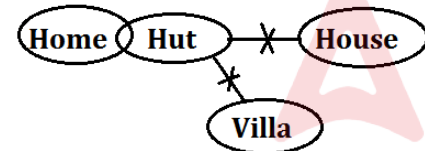

S135. Ans.(d)

Sol.

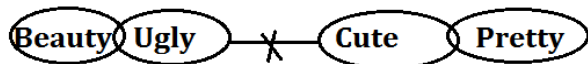

Solutions (136-140):

S136. Ans.(a)

Sol.

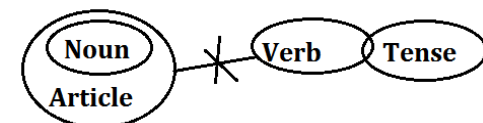

S137. Ans.(a)

Sol.

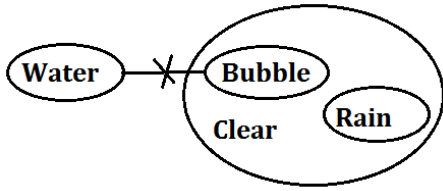

S138. Ans.(a)

Sol.

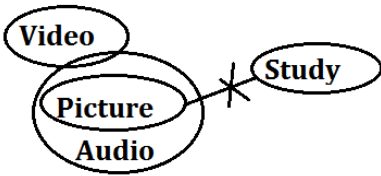

S139. Ans.(b)

Sol.

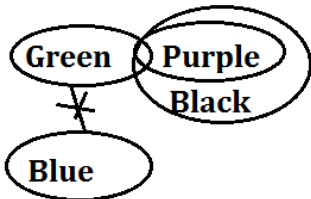

S140. Ans.(d)

Sol.

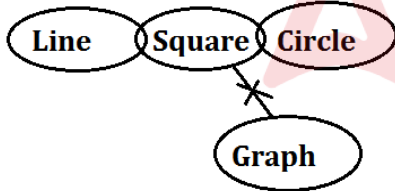

Solutions (141-145):

S141. Ans.(e)

Sol.

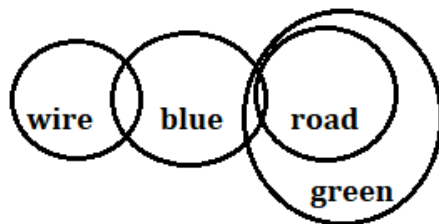

S142. Ans.(d)

Sol.

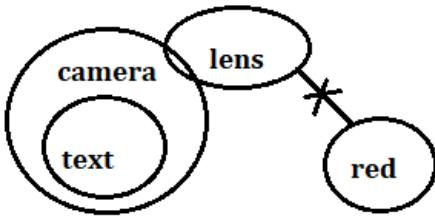

S143. Ans.(b)

Sol.

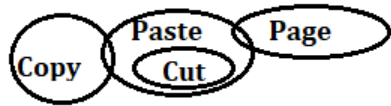

S144. Ans.(d)

Sol.

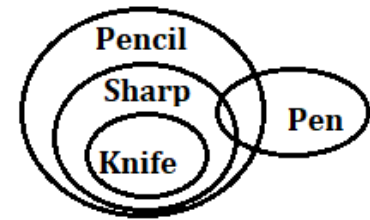

S145. Ans.(e)

Sol.

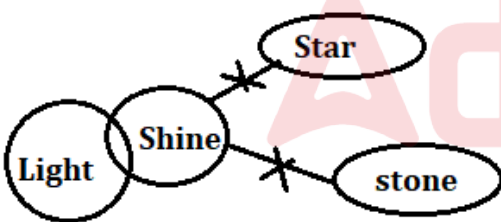

Solutions (46-50):

S146. Ans.(c)

Sol.

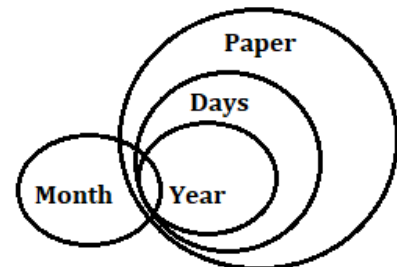

S147. Ans.(b)

Sol.

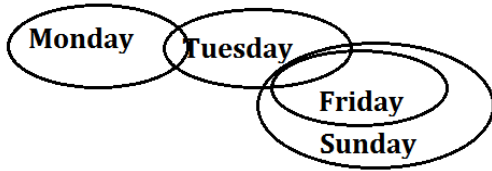

S148. Ans.(e)

Sol.

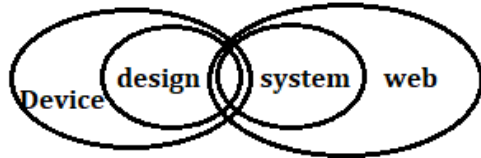

S149. Ans.(b)

Sol.

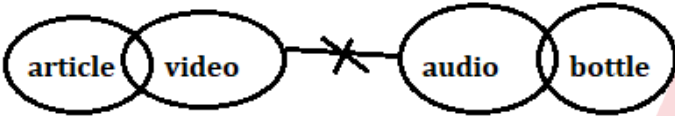

S150. Ans.(e)

Sol.

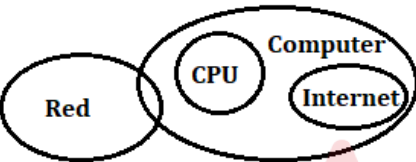

Solutions (151-155):

S151. Ans.(a)

Sol.

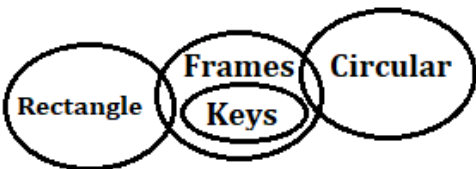

S152. Ans.(e)

Sol.

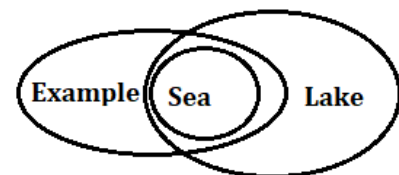

S153. Ans.(e)

Sol.

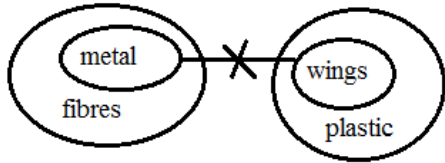

S154. Ans.(d)

Sol.

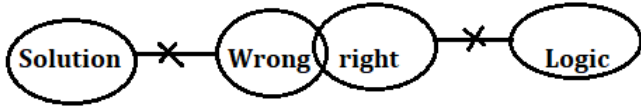

S155. Ans.(a)

Sol.

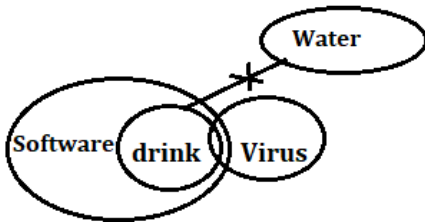

Solutions (156-160):

S156. Ans.(b)

Sol.



S157. Ans.(e)

Sol.

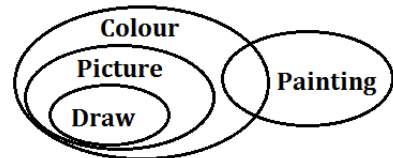

S158. Ans.(d)

Sol.

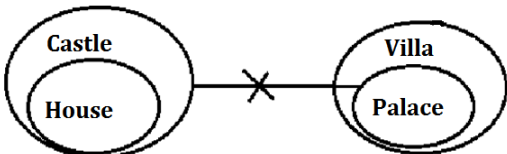

S159. Ans.(a)

Sol.

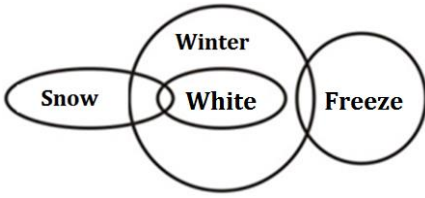

S160. Ans.(b)

Sol.

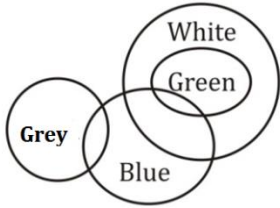

Solutions (161-165):

S161. Ans.(c)

Sol.

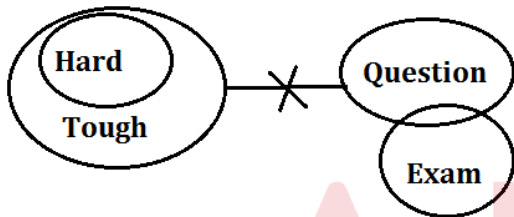

S162. Ans.(b)

Sol.

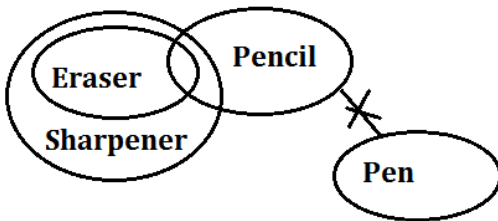

S163. Ans.(e)

Sol.

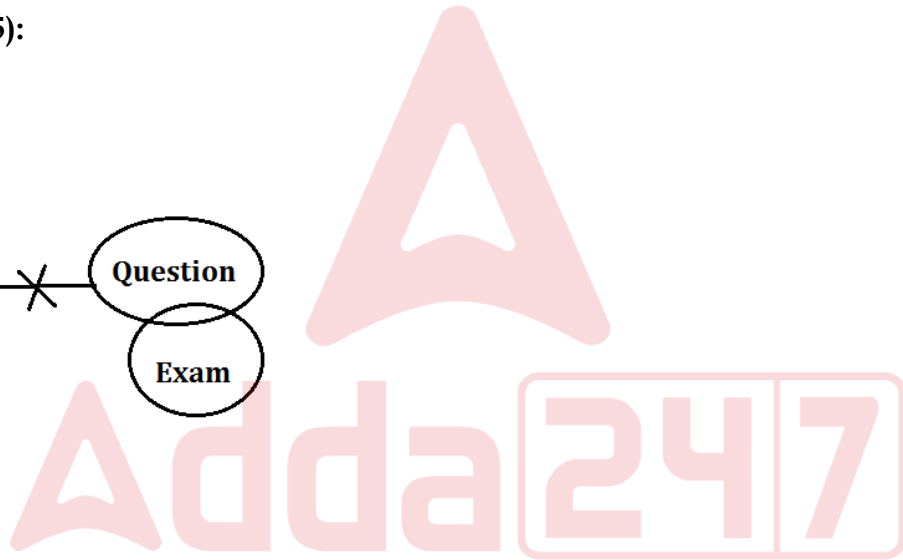
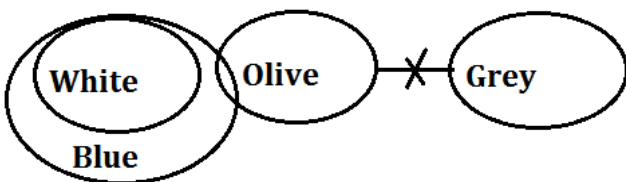

S164. Ans.(c)

Sol.

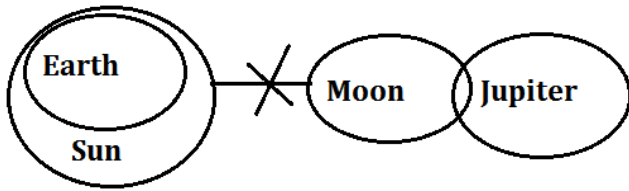

S165. Ans.(d)

Sol.

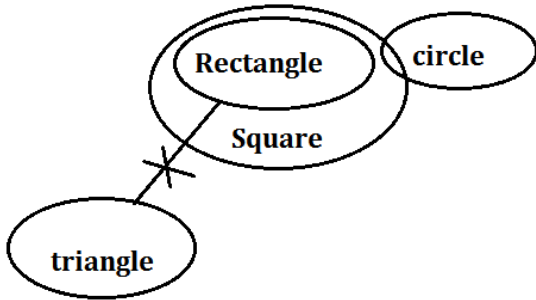

Solutions (166-170):

S166. Ans.(c)

Sol.

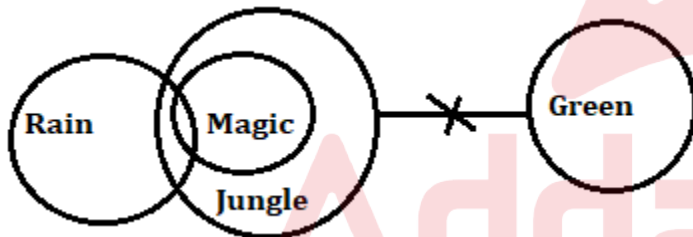

S167. Ans.(a)

Sol.

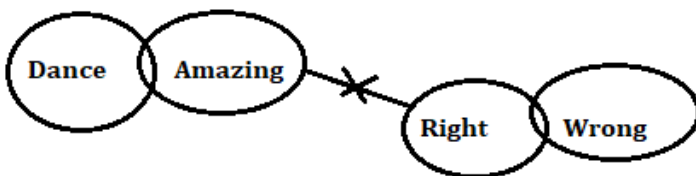

S168. Ans.(d)

Sol.

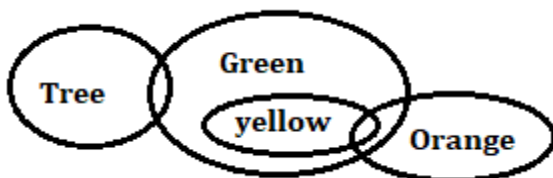

S169. Ans.(a)
Sol.

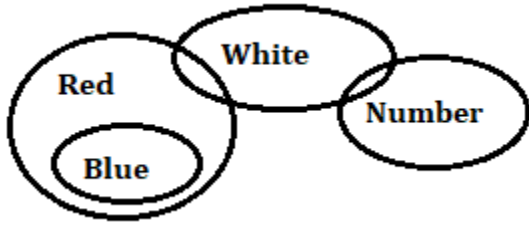

S170. Ans.(b)
Sol.

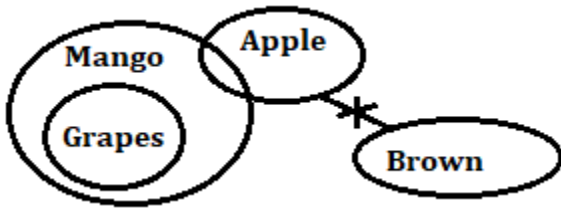

Solutions (171-175):

Date	22 nd	25 th
Month		
January	F	B
February	H	D
March	E	A
April	G	C

S171. Ans.(c)

S172. Ans.(a)

S173. Ans.(d)

S174. Ans.(b)

S175. Ans.(d)

Solutions (176-180):

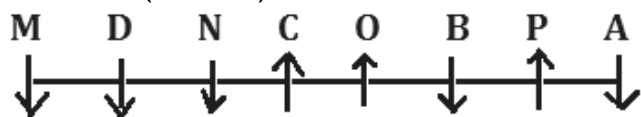

S176. Ans.(c)

S177. Ans.(e)

S178. Ans.(d)

S179. Ans.(c)

S180. Ans.(b)

S181. Ans.(a)

Sol. new number obtain is 7539573395 i.e. 5 and 3 is repeated more than two times.

S182. Ans.(b)

Sol.

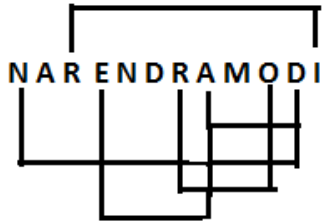

S183. Ans.(d)

S184. Ans.(a)

Total number of persons in the row= $(15+16-1)=30$

S185. Ans.(a)

Solutions (186-190):

Person	Colours
D	Black
A	Blue
E	white
F	Pink
B	Red
C	Yellow
G	Green

S186. Ans.(c)

S187. Ans.(a)

S188. Ans.(b)

S189. Ans.(d)

S190. Ans.(b)

Solution (191-195):

Person	Profession	State
A	Politician	Gujarat
B	Teacher	Uttarakhand
C	Doctor	Delhi
D	Pilot	Manipur/ Assam
E	Engineer	Manipur/ Assam
F	Businessman	Kerala
G	Manager	Orissa

S191. Ans.(c)

S192. Ans.(e)

S193. Ans.(d)

S194. Ans.(c)

S195. Ans.(a)

Solution (196-200):

Box
R
S
P
Q
T
W
U
V

S196. Ans.(c)

S197. Ans.(a)

S198. Ans.(b)



S199. Ans.(d)

S200. Ans.(b)

Solutions (201-205):

S201. Ans.(d)

Sol. I. $K \leq L$ (False) II. $Q < E$ (False)

S202. Ans.(a)

Sol. I. $Q > D$ (True) II. $D < Y$ (True)

S203. Ans.(b)

Sol. I. $Q < Y$ (False) II. $R \leq D$ (False)

S204. Ans.(e)

Sol. I. $T > S$ (True) II. $P < T$ (False)

S205. Ans.(b)

Sol. I. $H \geq R$ (False) II. $R < Q$ (True)

Solutions (206-210):

S206. Ans.(b)

Sol. I. $L > U$ (False) II. $H > U$ (True)

S207. Ans.(d)

Sol. I. $W > K$ (False) II. $J \geq C$ (False)

S208. Ans.(a)

Sol. I. $Z > P$ (True) II. $X = P$ (False)

S209. Ans.(e)

Sol. I. $J > F$ (True) II. $K > Z$ (True)

S210. Ans.(b)

Sol. I. $X < Y$ (False) II. $Z > Q$ (True)

Solutions (211-215):

S211. Ans.(c)

Sol. I. $Y < B$ (True) II. $C \geq Q$ (False)

S212. Ans.(d)

Sol. I. $A = J$ (False) **II.** $A > J$ (False)

S213. Ans.(a)

Sol. I. $H > T$ (True) **II.** $H > G$ (True)

S214. Ans.(d)

Sol. I. $N < X$ (False) **II.** $M > F$ (False)

S215. Ans.(c)

Sol. I. $W \geq P$ (False) **II.** $R > K$ (True)

Solutions (216-220):

S216. Ans.(b)

Sol. I: $Q < O$ (False) **II:** $M < C$ (True)

S217. Ans.(b)

Sol. I: $D \geq X$ (False) **II:** $T < Z$ (True)

S218. Ans.(c)

Sol. I: $K < W$ (False) **II:** $W = K$ (False)

S219. Ans.(c)

Sol. I: $Z \geq B$ (False) **II:** $B > Z$ (False)

S220. Ans.(a)

Sol. I: $L < G$ (True) **II:** $T > N$ (False)

Solutions (221-224):

S221. Ans.(a)

S222. Ans.(b)

S223. Ans.(c)

S224. Ans.(d)

S225. Ans.(a)

S226. Ans.(d)

Sol. TRANSPORT
ANOPRRSTT

S227. Ans.(e)

Sol. PR20

S228. Ans.(d)

S229. Ans.(c)

Solutions (230-234):

S230. Ans.(c)

Sol. I. $H=G$ (False)

II. $G<H$ (False)

S231. Ans.(b)

Sol. I. $W>S$ (False)

II. $T>P$ (True)

S232. Ans.(b)

Sol. I. $Z>U$ (False)

II. $W<T$ (True)

S233. Ans.(a)

Sol. I. $P>K$ (True)

II. $N>O$ (False)

S234. Ans.(d)

Sol. I. $B\leq E$ (False)

II. $C>E$ (False)

Solutions (235-237):

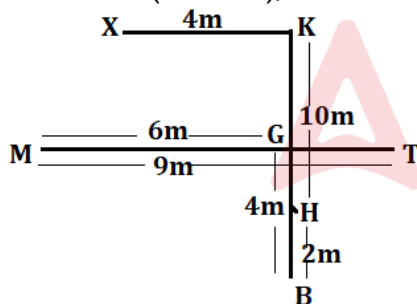

S235. Ans.(a)

S236. Ans.(c)

S237. Ans.(c)

Solutions (238-240):

$V>R>T>P>S>Q$

S238. Ans.(e)

S239. Ans.(b)

S240. Ans.(a)

S241. Ans.(d)

Sol.

BASKETBALL

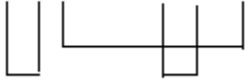

S242. Ans.(c)

Solutions (243-247):

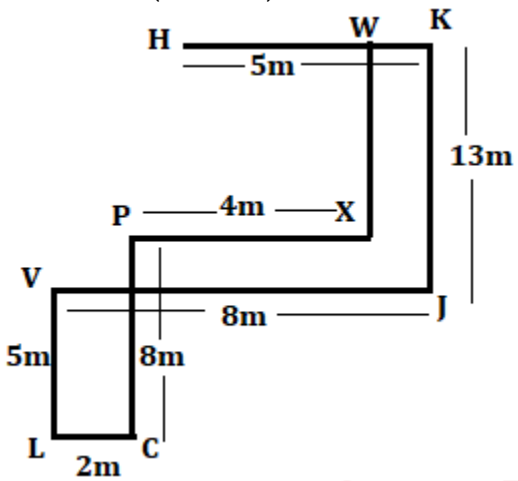

S243. Ans.(a)

S244. Ans.(b)

S245. Ans.(c)

S246. Ans.(c)

S247. Ans.(c)

S248. Ans.(a)

Sol. Original Word- DISCUSSION

After operation- SSSNDCUOII

Solutions (249-250):

$U > P > T > R > S > Q$ (40)

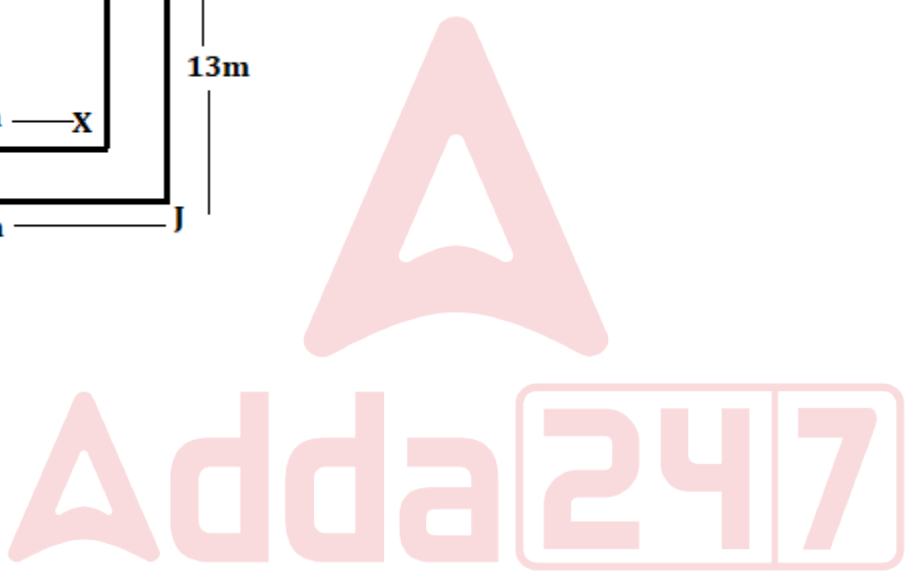

S249. Ans.(a)

S250. Ans.(d)

S251. Ans.(b)

Sol.

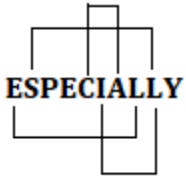

S252. Ans.(e)

Sol. Original number- 536712493

Obtained number- 553366442

Solutions (253-257):

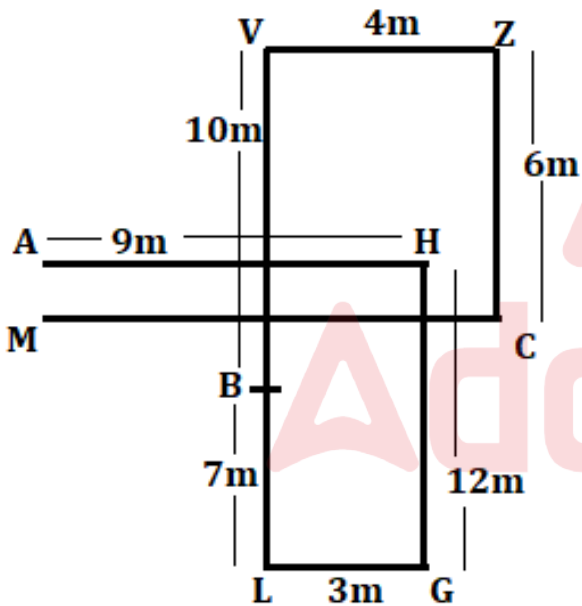

S253. Ans.(b)

S254. Ans.(b)

S255. Ans.(c)

S256. Ans.(c)

S257. Ans.(e)

Solutions (258-259):

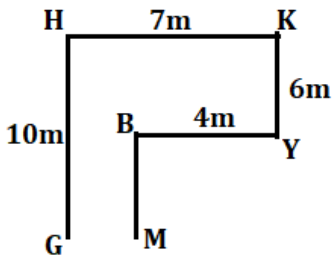

S258. Ans.(c)

S259. Ans.(c)

S260. Ans.(a)

Sol. $R > P > Q > T > S$

Solutions (261-262):

M(+) = O(-)



J(+) = L(-)



N(-) = K(+)

S261. Ans.(b)

S262. Ans.(d)

Solutions (263-264):

$B > F > C > E > A (60) > D$

S263. Ans.(c)

S264. Ans.(d)

Solutions (265-266):

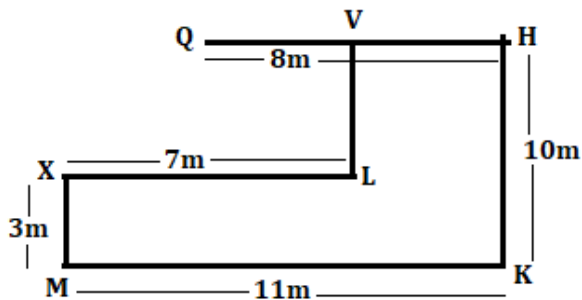

S265. Ans.(d)

S266. Ans.(d)

Solutions (267-269):

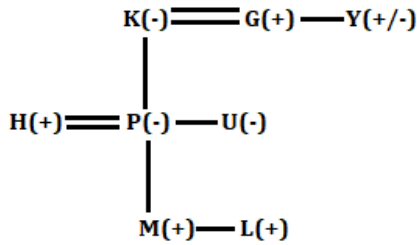

S267. Ans.(b)

S268. Ans.(d)

S269. Ans.(e)

S270. Ans.(a)

S271. Ans.(e)

Sol.

□ □
STRENGTHEN

Solutions (272-274):

S272. Ans.(c)

Sol.

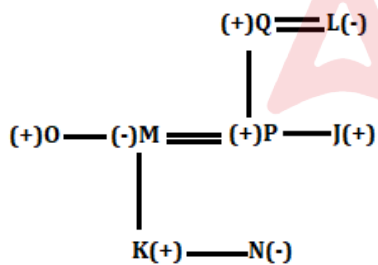

S273. Ans.(d)

Sol.

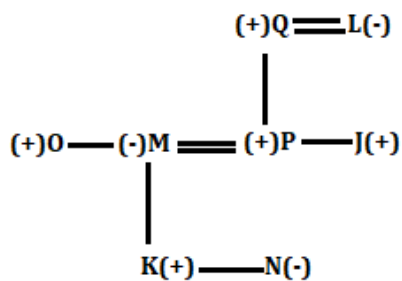

S274. Ans.(b)

Sol.

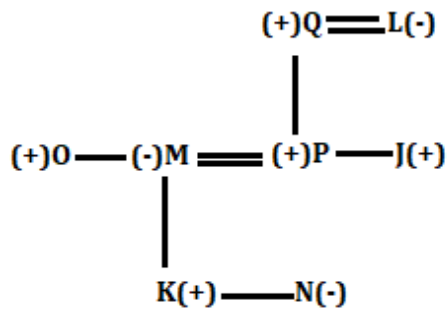

S275. Ans.(c)

S276. Ans.(a)

Solutions (277-279):

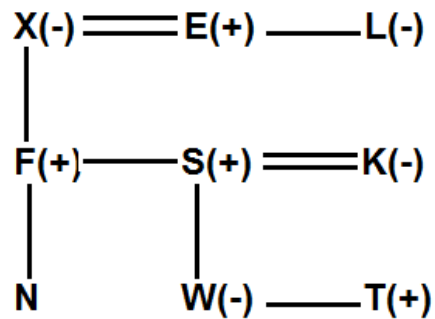

S277. Ans.(d)

S278. Ans.(d)

S279. Ans.(d)

Solutions (280-281):

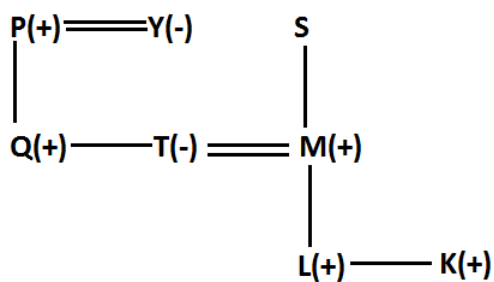

S280. Ans.(e)

S281. Ans.(c)

Solutions (282-284):

S282. Ans.(d)

Sol.

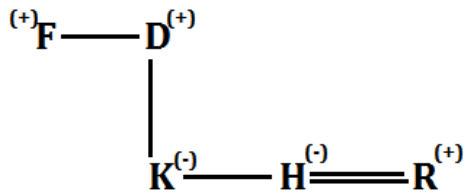

S283. Ans.(a)

Sol.

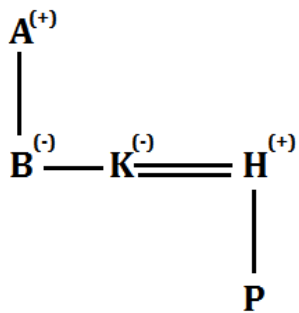

S284. Ans.(e)

Sol.

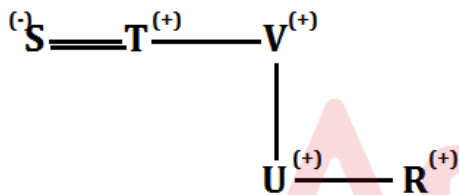

Solutions (285-287):

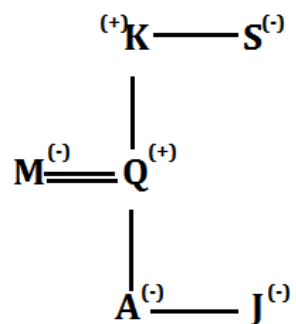

S285. Ans.(a)

S286. Ans.(d)

S287. Ans.(b)

Solutions (288-289):

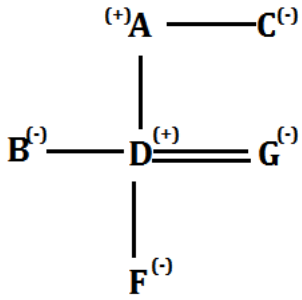

S288. Ans.(c)

S289. Ans.(d)

Solutions (290-291):

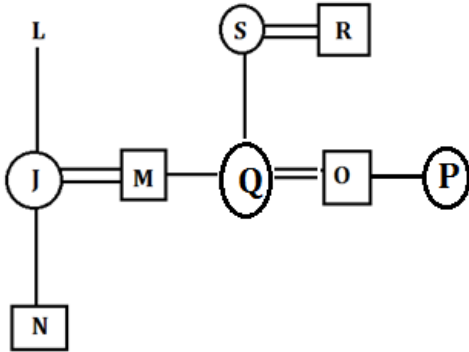

S290. Ans.(c)

S291. Ans.(d)

S292. Ans.(c)

Solutions (293-295):

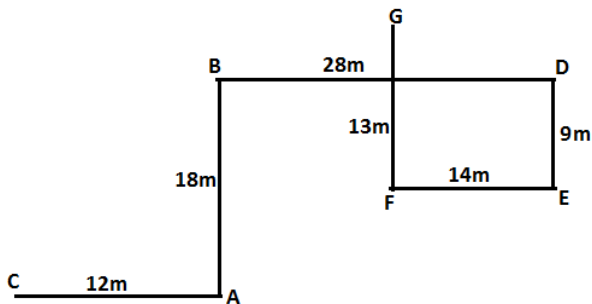

S293. Ans.(e)

S294. Ans.(c)

S295. Ans.(d)

Solutions (296-298):

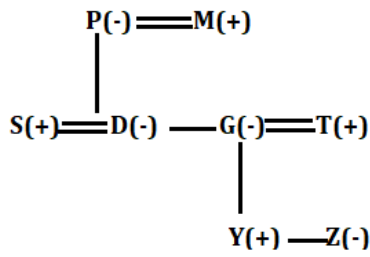

S296. Ans.(c)

S297. Ans.(c)

S298. Ans.(e)

Solutions (299-300):

S299. Ans.(a)

Sol. I. $G > D$ (False) II. $O > I$ (True)

S300. Ans.(a)

Sol. I. $W > Q$ (False) II. $Z > K$ (True)

Solutions (301-305):

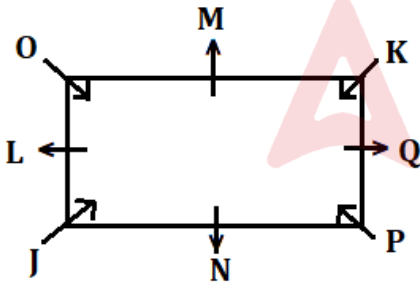

S301. Ans.(b)

S302. Ans.(c)

S303. Ans.(d)

S304. Ans.(e)

S305. Ans.(c)

Solution (306-310):

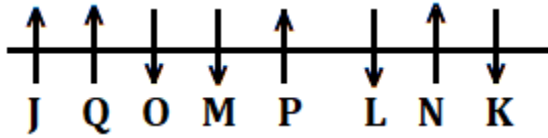

S306. Ans.(d)

S307. Ans.(a)

S308. Ans.(e)

S309. Ans.(e)

S310. Ans.(a)

Solutions (311-315):

Ministry	Allocated Amounts (in crore)
Defence	35
Education	90
Transport	70
Health	64
Energy	40
Telecom	60
Agriculture	55

S311. Ans.(c)

S312. Ans.(d)

S313. Ans.(a)

S314. Ans.(d)

S315. Ans.(d)

Solutions (316-320):

Floors	Persons
8	R
7	T
6	P
5	S
4	U
3	V
2	Q
1	W

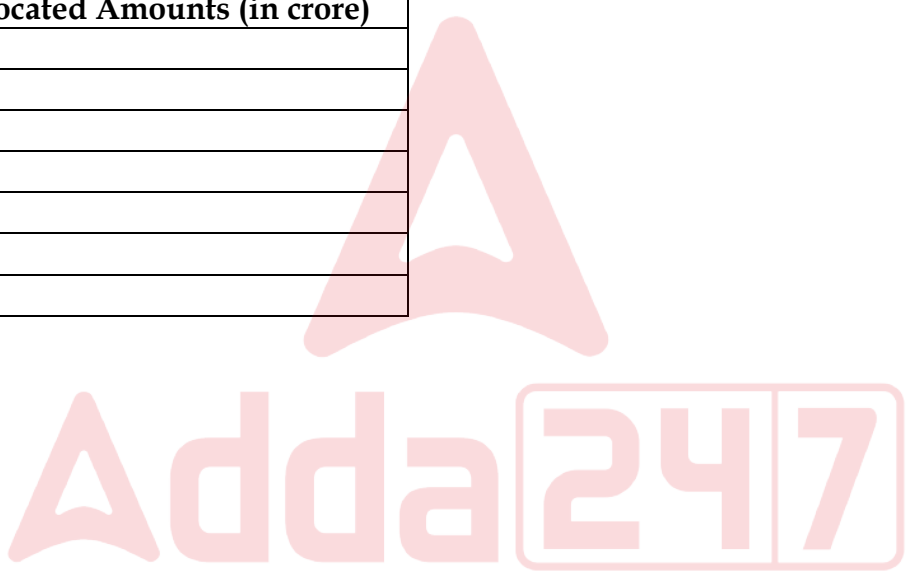

S316. Ans.(a)

S317. Ans.(b)

S318. Ans.(b)

S319. Ans.(e)

S320. Ans.(a)

Solutions (321-325):

Floors	Students	Ages
7	R	25
6	N	11
5	Q	18
4	M	27
3	O	30
2	S	13
1	P	28

S321. Ans.(d)

S322. Ans.(c)

S323. Ans.(d)

S324. Ans.(a)

S325. Ans.(d)

Solutions (326-330):

Boxes
Mango
Pineapple
Banana
Apple
Guava
Orange
Grapes
Litchi



S326. Ans.(a)

S327. Ans.(c)

S328. Ans.(d)

S329. Ans.(d)

S330. Ans.(c)

Solutions (331-335):

Month	Persons
March	P
April	T
May	V
June	Q
July	S
August	W
September	U
October	R

S331. Ans.(b)

S332. Ans.(d)

S333. Ans.(c)

S334. Ans.(e)

S335. Ans.(a)

Solutions (336-340):

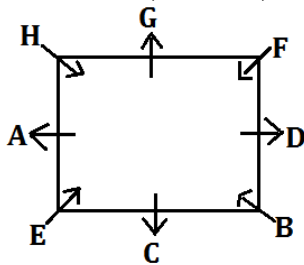

S336. Ans.(d)



S337. Ans.(e)

S338. Ans.(c)

S339. Ans.(a)

S340. Ans.(b)

Solution (341-345):

FLOOR	PERSONS
8	R
7	T
6	V
5	U
4	Q
3	W
2	S
1	P

S341. Ans.(e)

S342. Ans.(d)

S343. Ans.(b)

S344. Ans.(a)

S345. Ans.(c)

Solutions (346-350):

Floor	Person	Country
7	G	France
6	E	Germany
5	A	India
4	D	Russia
3	F	Japan
2	B	Australia
1	C	China

S346. Ans.(d)

S347. Ans.(c)

S348. Ans.(a)

S349. Ans.(d)

S350. Ans.(b)

Solutions (351-355):

BOX	ITEMS
A	Flower
E	Books
B	Chocolate
D	Fruit
C	Toy
F	Watches

S351. Ans.(d)

S352. Ans.(c)

S353. Ans.(b)

S354. Ans.(c)

S355. Ans.(a)

Solutions (356-360):

Date Month	10th	11th
January	Y	X
February	W	N
March	Z	O
April	M	V

S356. Ans.(c)

S357. Ans.(d)

S358. Ans.(a)

S359. Ans.(d)

S360. Ans.(d)

Solutions (361-365):

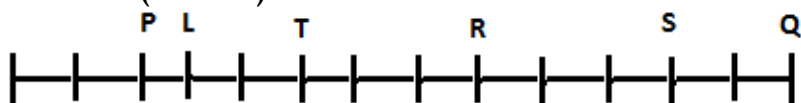

S361. Ans.(c)

S362. Ans.(c)

S363. Ans.(b)

S364. Ans.(c)

S365. Ans.(c)

Solutions (366-370):

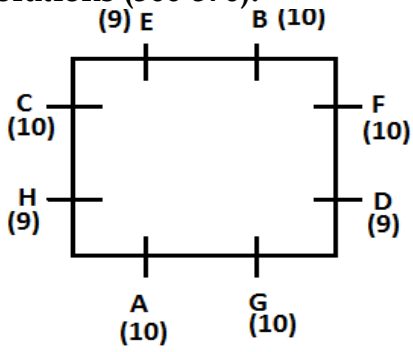

S366. Ans.(a)

S367. Ans.(e)

S368. Ans.(a)

S369. Ans.(e)

S370. Ans.(a)

Solutions (371-375):

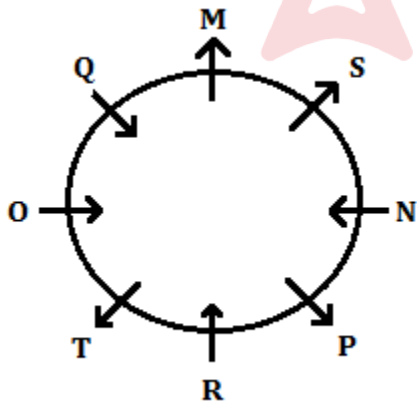

S371. Ans.(c)

S372. Ans.(d)

S373. Ans.(b)

S374. Ans.(a)

S375. Ans.(e)

Solutions (376-380):

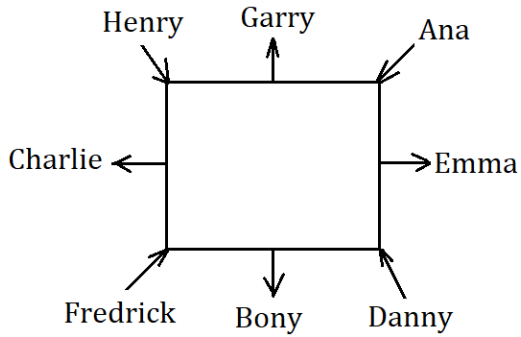

S376. Ans.(a)

S377. Ans.(b)

S378. Ans.(d)

S379. Ans.(e)

S380. Ans.(d)

Solutions (381-385)

Floors	Persons
9	P6
8	P8
7	P2
6	P9
5	P1
4	P4
3	P7
2	P3
1	P5

S381. Ans.(e)

S382. Ans.(b)

S383. Ans.(b)

S384. Ans.(a)

S385. Ans.(d)

Solutions (386-390):

Months	Persons
March	A
April	D
May	G
June	F
July	B
August	E
September	C

S386. Ans.(b)

S387. Ans.(d)

S388. Ans.(c)

S389. Ans.(e)

S390. Ans.(b)

Solutions (391-395)

	A	E	B	F	D	C
row 1	-	-	-	-	-	-
row 2	-	-	-	-	-	-
	K	L	M	N	I	G

S391. Ans.(c)

S392. Ans.(a)

S393. Ans.(d)

S394. Ans.(e)

S395. Ans.(b)

Solutions (396-400)

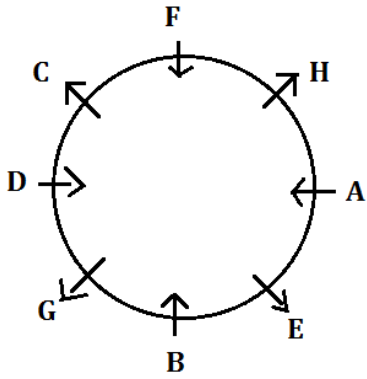

S396. Ans.(b)

S397. Ans.(d)

S398. Ans.(c)

S399. Ans.(a)

S400. Ans.(d)

Solutions (401-405):

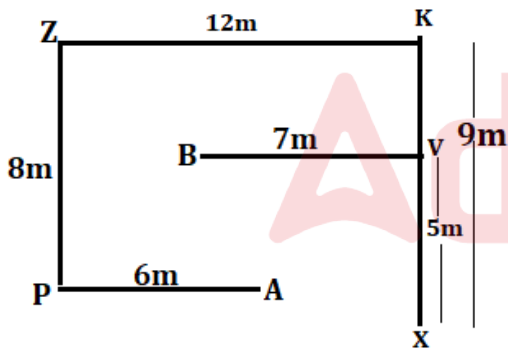

S401. Ans.(c)

S402. Ans.(d)

S403. Ans.(a)

S404. Ans.(a)

S405. Ans.(d)

Solution (406-407):

S406. Ans.(b)

Sol.

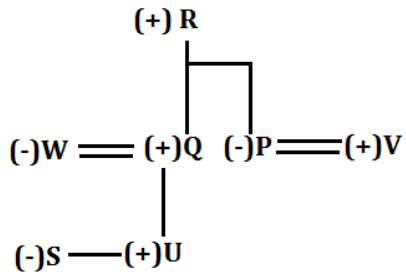

S407. Ans.(a)

Sol.

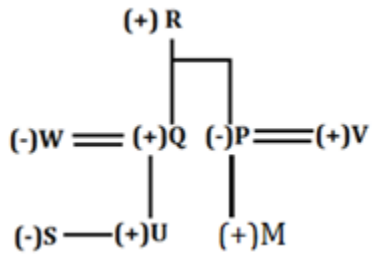

Solutions (408-409):

Sol.

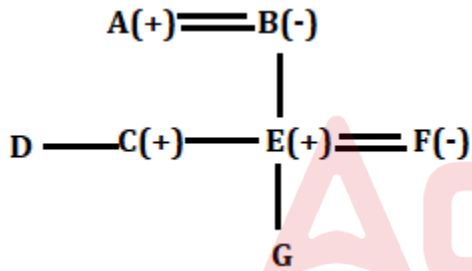

S408. Ans.(e)

S409. Ans.(a)

S410. Ans.(e)

Sol.

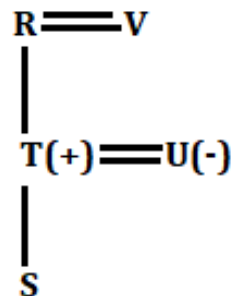

Solutions (411-413):

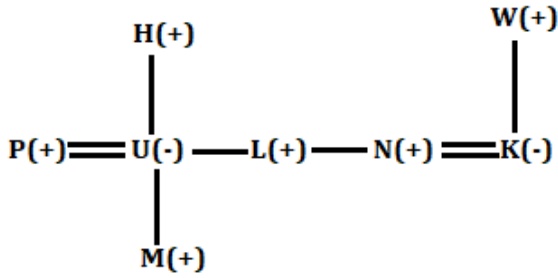

S411. Ans.(c)

S412. Ans.(b)

S413. Ans.(d)

S414. Ans.(d)

S415. Ans.(e)

Sol.

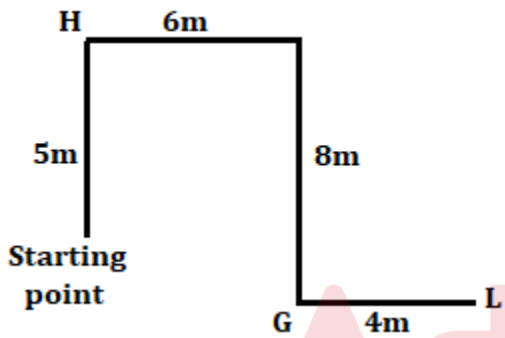

Solutions (416-420):

S416. Ans.(d)

Sol. I. $D > F$ (False) II. $A > W$ (False)

S417. Ans.(a)

Sol. I. $Q > S$ (True) II. $F > B$ (False)

S418. Ans.(b)

Sol. I. $Q \geq J$ (False) II. $T > J$ (True)

S419. Ans.(e)

Sol. I. $B > A$ (True) II. $S > C$ (True)

S420. Ans.(d)

Sol. I. $R \geq A$ (False) II. $A < R$ (False)

Solutions (421-424):

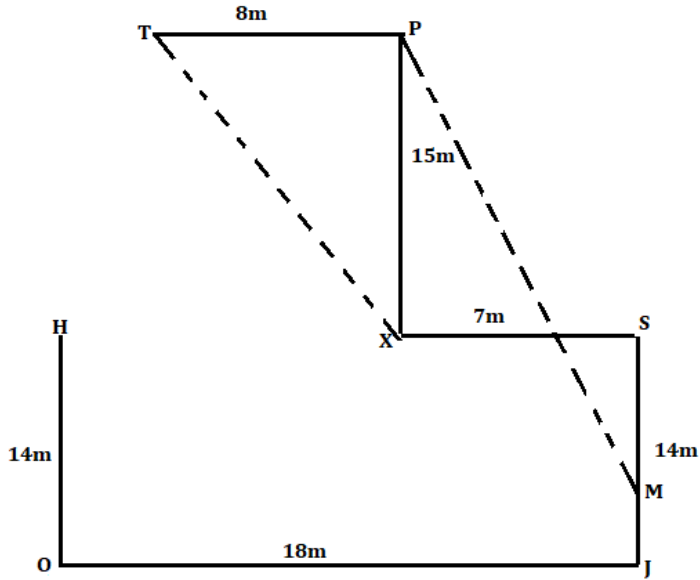

S421. Ans.(d)

S422. Ans.(b)

S423. Ans.(e)

S424. Ans.(a)

S425. Ans.(d)

Solutions (426-430):

S426. Ans.(a)

Sol.

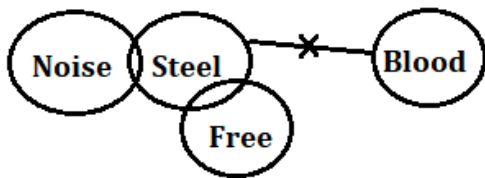

S427. Ans.(e)

Sol.

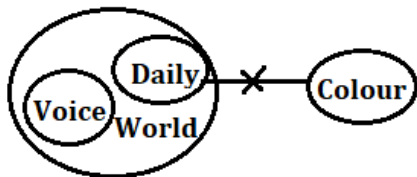

S428. Ans.(d)

Sol.

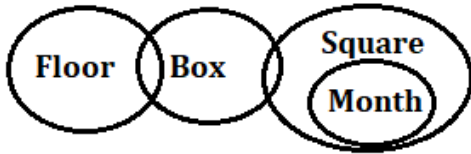

S429. Ans.(e)

Sol.

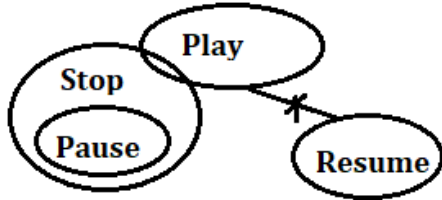

S430. Ans.(c)

Sol.

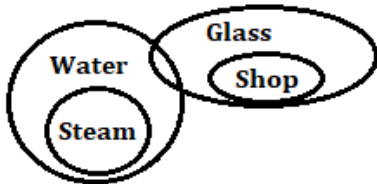

Solutions (431-435):

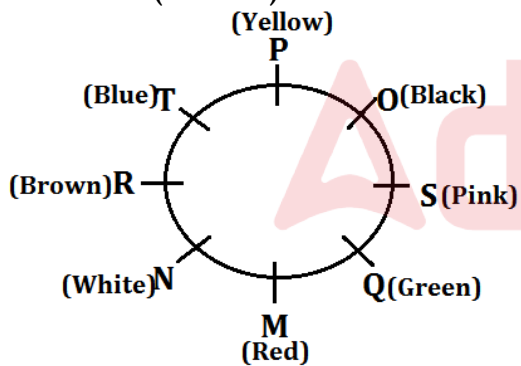

S431. Ans.(b)

S432. Ans.(c)

S433. Ans.(d)

S434. Ans.(d)

S435. Ans.(a)

S436. Ans.(d)

Sol. Original Word- TREATMENT

After Applied given conditions- BFFLMQSSS

S437. Ans.(d)

Sol. JOIN

S438. Ans.(b)

Sol. Original Number- 364872159

After applied given conditions-244566788

S439. Ans.(d)

S440. Ans.(c)

Sol.



Solutions (441-445):

S441. Ans.(a)

S442. Ans.(d)

S443. Ans.(b)

S444. Ans.(a)

S445. Ans.(d)

Solutions (446-450):

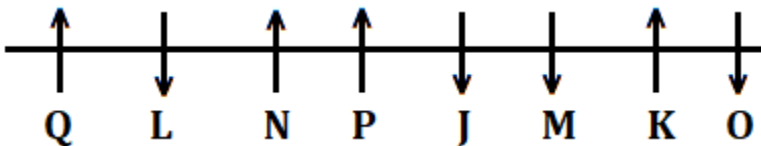

S446. Ans.(a)

S447. Ans.(d)

S448. Ans.(e)

S449. Ans.(b)

S450. Ans.(d)

S451. Ans.(d)

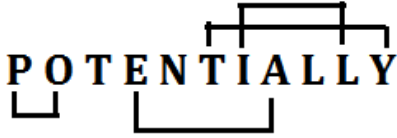

S452. Ans.(a)

Sol. Near, Earn

S453. Ans.(a)

Sol. Original word- DELIGHT

Obtained word- EIDGHLT

S454. Ans.(c)

Sol. Payal position from right end = $(47+1-21) = 27$

Students between them = $(27-23-1) = 3$

S455. Ans.(b)

Sol. Number of students in the class = $13+34-1=46$

Solutions (456-460):

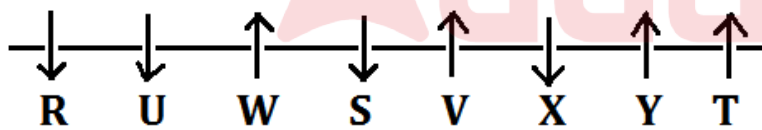

S456. Ans.(c)

S457. Ans.(a)

S458. Ans.(d)

S459. Ans.(a)

S460. Ans.(b)

Solutions (461-465):

Date	17 th	28 th
January	Z	J
February	A	X
March	C	B
April	Y	K

S461. Ans.(e)

S462. Ans.(b)

S463. Ans.(a)

S464. Ans.(c)

S465. Ans.(a)

Solutions (466-470):

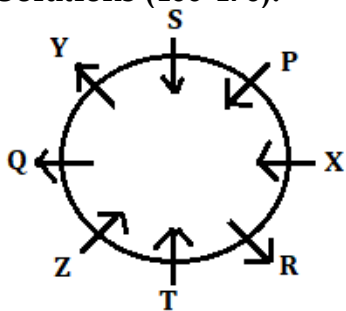

S466. Ans.(b)

S467. Ans.(a)

S468. Ans.(b)

S469. Ans.(c)

S470. Ans.(a)

Solutions (471-475):

Floor	Persons	Colours
7	T	Black
6	Q	Purple
5	V	Blue
4	R	Yellow
3	U	Green
2	P	Pink
1	S	White



S471. Ans.(c)

S472. Ans.(d)

S473. Ans.(b)

S474. Ans.(a)

S475. Ans.(d)

S476. Ans.(c)

Sol. Number of boys who passed = $(39 + 45 - 1) = 83$

∴ Total number of boys in the class = $(83 + 3 + 10) = 96$

S477. Ans.(a)

Solutions (478-480):

Box
F
K
M
B
L
D
R

S478. Ans.(c)

S479. Ans.(b)

S480. Ans.(a)

Solutions (481-485):

Day	Friend	Sport
Monday	D	Baseball
Tuesday	E	Cricket
Wednesday	F	Tennis
Thursday	B	Badminton
Friday	C	Volleyball
Saturday	A	Hockey
Sunday	G	Football



S481. Ans.(b)

S482. Ans.(e)

S483. Ans.(b)

S484. Ans.(c)

S485. Ans.(b)

Solution (486-490):

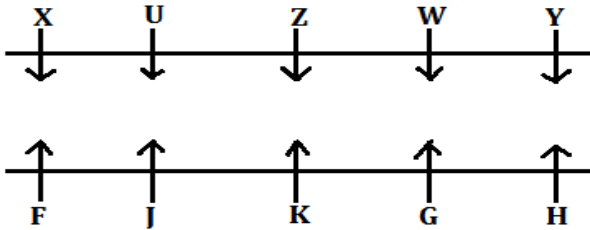

S486. Ans.(a)

S487. Ans.(b)

S488. Ans.(e)

S489. Ans.(c)

S490. Ans.(d)

Solution (491-495):

Date	13 th	28 th
March	P	R
April	V	T
May	S	Q
June	U	W

S491. Ans.(b)

S492. Ans.(a)

S493. Ans.(c)

S494. Ans.(b)

S495. Ans.(d)

Solutions (496-498):

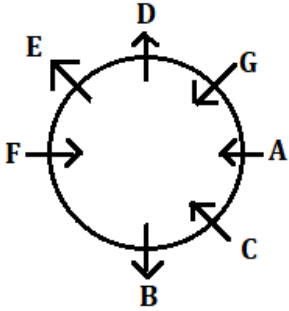

S496. Ans.(d)

S497. Ans.(a)

S498. Ans.(c)

S499. Ans.(b)

Sol. Original number: 8154276367

Obtained number: 1234566778

S500. Ans.(c)

Sol.

