

## SBI PO Pre 2024-25 Memory Based Paper 8-March-2025-4th shift

**Q1. In the question, one word is given in bold and correspondence to that, three sentences are given each containing that word. Choose the option depicting the sentence(s) that have/ has the correct usage of the word.**

### SUSTAIN

- (I) The bridge was not strong enough to **sustain** the weight of heavy trucks, so it collapsed under pressure.  
(II) She tried to **sustain** her argument with valid evidence, but her points were weak and unconvincing.  
(III) The athlete's injury was so severe that he could not **sustain** his career any longer.
- (a) Only (I)  
(b) Both (I) and (II)  
(c) Only (III)  
(d) Both (I) and (III)  
(e) All (I), (II), and (III)

**Q2. In the question, one word is given in bold and correspondence to that, three sentences are given each containing that word. Choose the option depicting the sentence(s) that have/ has the correct usage of the word.**

### IDOL

- (I) The young singer considered the legendary musician her **idol** and aspired to follow in his footsteps.  
(II) The villagers placed an **idol** of the deity in the temple and performed daily prayers.  
(III) His strong work ethic and leadership skills made him an **idol** among his colleagues.
- (a) Only (I)  
(b) Both (I) and (II)  
(c) Only (III)  
(d) Both (I) and (III)  
(e) All (I), (II), and (III)

**Q3. In the given question, two words are omitted, which are replaced by blanks. Choose the best combination of the words that can fit into the given blank at the same order so to make a grammatically and logically correct statement.**

The village elder spoke with quiet \_\_\_\_\_, and though his words were few, they carried a weight that seemed to \_\_\_\_\_ through the crowd.

- (a) arrogance, drift  
(b) authority, ripple  
(c) timidity, vanish  
(d) humor, meander  
(e) vigor, echo

**Q4. In the given question, two words are omitted, which are replaced by blanks. Choose the best combination of the words that can fit into the given blank at the same order so to make a grammatically and logically correct statement.**

Even in the face of relentless failure, her spirit remained \_\_\_\_\_, and her unwavering focus began to \_\_\_\_\_ those who had once doubted her.

- (a) fragile, dismiss
- (b) mellow, silence
- (c) apathetic, alienate
- (d) wavering, confuse
- (e) tenacious, inspire

**Q5. In the given question, two words are omitted, which are replaced by blanks. Choose the best combination of the words that can fit into the given blank at the same order so to make a grammatically and logically correct statement.**

The castle stood in \_\_\_\_\_ silence under the moonlight, its broken towers and cracked stones a silent \_\_\_\_\_ to forgotten wars.

- (a) giddy, tribute
- (b) ominous, testament
- (c) joyful, narrative
- (d) rustic, spectacles
- (e) glorious, monumental

**Q6. In the given question, two words are omitted, which are replaced by blanks. Choose the best combination of the words that can fit into the given blank at the same order so to make a grammatically and logically correct statement.**

As the final notes of the symphony faded, a deep \_\_\_\_\_ filled the concert hall, leaving the audience to \_\_\_\_\_ in quiet awe.

- (a) uproar, fidget
- (b) discord, erupt
- (c) humdrum, scatter
- (d) resonance, linger
- (e) blare, jolt

**Q7. In the given question, two words are omitted, which are replaced by blanks. Choose the best combination of the words that can fit into the given blank at the same order so to make a grammatically and logically correct statement.**

The journalist's report was both \_\_\_\_\_ and revealing, managing to \_\_\_\_\_ even the most well-guarded aspects of the scandal.

- (a) calculation, observe
- (b) insightful, uncover
- (c) biased, interrupt
- (d) redundant, simplify
- (e) vague, uncovering

**Directions (8-16): Read the following passage and answer the given questions.**

In recent years, the population of pigeons in urban areas has swelled significantly, raising concerns about the health risks they pose. Studies indicate that pigeon populations in major cities have increased by over 30% in the past decade, largely due to human feeding habits and the lack of natural predators. These birds, often seen flocking in public squares, rooftops, and balconies, have **adapted** remarkably well to city life. One of the primary reasons for their unchecked growth is the continuous feeding by humans. In places like London and New York, feeding pigeons has led to colonies numbering in the hundreds of thousands, creating sanitation and health challenges.

Pigeons are not just harmless city dwellers; they bring with them a host of potential health risks. They build their nests in \_\_\_\_\_ of our homes, leading to an accumulation of droppings, feathers, and parasites. Research from the Centers for Disease Control and Prevention (CDC) states that pigeon droppings contain over 60 types of pathogens, including fungi, bacteria, and viruses. These pathogens can cause respiratory diseases like histoplasmosis, cryptococcosis, and psittacosis, particularly in individuals with weakened immune systems. Additionally, pigeon droppings are highly acidic, leading to the gradual erosion of buildings, monuments, and infrastructure.

One of the biggest concerns is the spread of mites, ticks, and fleas from pigeons to humans. A study conducted in Barcelona in 2022 found that 70% of pigeons carried ectoparasites that can infest homes and trigger allergic reactions. Furthermore, their presence in large numbers contributes to increased airborne allergens, worsening conditions for people with asthma or respiratory issues.

Efforts to control their population should focus on reducing their dependence on human feeding and making nesting areas less accessible. Many cities have started implementing deterrent measures such as installing anti-roosting spikes, netting, and automated bird-repelling devices. Some regions, like Venice and Singapore, have introduced fines for feeding pigeons, leading to a 25% reduction in pigeon numbers over five years.

The unchecked growth of pigeon populations is like a **battery** of problems waiting to explode. If we do not take preventive measures, we might find ourselves caught in a **thread** of complications that could have been easily avoided. It is time to address this issue seriously, balancing conservation with public health and urban hygiene.

**Q8. Identify the correct statement(s) based on the passage:**

- (I) Pigeon populations in urban areas have seen a rapid increase, primarily due to factors such as human intervention and favorable breeding conditions.
  - (II) The CDC has classified pigeon droppings as hazardous biological waste due to the presence of over 60 different pathogens.
  - (III) Certain cities have managed to significantly reduce pigeon numbers over time by using legal deterrents and physical barriers.
- (a) Only (I)
  - (b) Both (I) and (II)
  - (c) Only (III)
  - (d) Both (I) and (III)
  - (e) All (I), (II), and (III)

**Q9. Identify the incorrect statement(s) based on the passage:**

- (I) Pigeons are difficult to control due to their natural resistance to deterrents like spikes and netting.
- (II) Cities implementing strict anti-feeding laws have witnessed a notable decrease in pigeon populations.
- (III) Pigeon droppings pose a structural threat to buildings due to their acidic nature, leading to long-term damage.

- (a) Only (I)
- (b) Both (I) and (II)
- (c) Only (III)
- (d) Both (II) and (III)
- (e) All (I), (II), and (III)

**Q10. Identify the incorrect statement(s) based on the passage:**

- (I) Pigeons contribute to urban hygiene problems as their droppings corrode buildings and create sanitation challenges.
- (II) A study in Barcelona found that nearly all pigeons carried ectoparasites, which significantly threaten human health.
- (III) While pigeons pose health risks, their impact on individuals with respiratory issues remains unproven.

- (a) Only (II)
- (b) Both (II) and (III)
- (c) Only (I)
- (d) Both (I) and (III)
- (e) All (I), (II), and (III)

**Q11. Find the word similar in meaning to "battery" as used in the passage.**

- (a) Power source
- (b) Assault
- (c) Sequence
- (d) Series
- (e) Explosion

**Q12. Find the word similar in meaning to "thread" as used in the passage.**

- (a) Fiber
- (b) Discussion
- (c) Chain
- (d) Narrative
- (e) Link

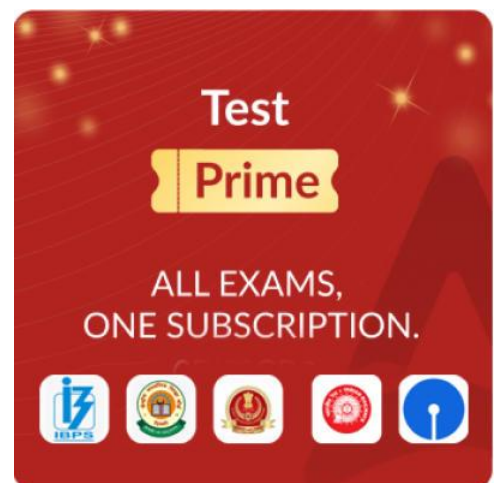

**Q13. Choose the correct option to fill in the blank:**

- (a) Heart and soul
- (b) Nuts and bolts
- (c) Nooks and corners
- (d) Thick and thin
- (e) Odds and ends

**Q14. Which of the following best explains why pigeons have successfully adapted to urban environments?**

- (a) They have a natural resistance to city pollution.
- (b) Urban architecture provides ample nesting spaces.
- (c) They are genetically predisposed to thrive in human-dominated spaces.
- (d) They are fed by humans and face fewer natural predators.
- (e) The presence of artificial lighting in cities improves their survival rates.

**Q15. Which of the following has been implemented in some cities to control pigeon populations?**

- (a) Releasing trained hawks and falcons to prey on pigeons.
- (b) Deploying ultrasonic sound devices to repel pigeons.
- (c) Introducing chemical sterilization to limit pigeon reproduction.
- (d) Imposing fines for feeding pigeons and using deterrents like spikes and nets.
- (e) Relocating pigeons to designated rural areas.

**Q16. Find the word similar in meaning to "adapted" as used in the passage.**

- (a) Adjusted
- (b) Modified
- (c) Created
- (d) Rejected
- (e) Improved

**Directions (17-21): Rearrange the following sentences to form a contextually meaningful paragraph and answer the questions that follow.**

- A.** Although traditional treatments like chemotherapy and radiation remain widely used, they often cause significant side effects.
- B.** Consequently, many global health organizations have increased funding and collaboration efforts to accelerate breakthroughs in cancer treatment.
- C.** Therefore, scientists are now focusing on precision medicine, which tailors' treatment based on the patient's genetic profile.
- D.** Cancer research has seen remarkable advancements in recent years, especially with the emergence of targeted therapies and immunotherapy.
- E.** However, the high cost of innovative treatments continues to raise concerns about accessibility and healthcare inequality.

**Q17.** Which of the following is the **third sentence** after rearrangement?

- (a) E
- (b) B
- (c) A
- (d) D
- (e) C

**Q18.** Which of the following is the **first sentence** after rearrangement?

- (a) A
- (b) B
- (c) C
- (d) D
- (e) E

**Q19.** Which of the following is the **last sentence** after rearrangement?

- (a) B
- (b) D
- (c) C
- (d) A
- (e) E

**Q20.** Which of the following is the **second sentence** after rearrangement?

- (a) C
- (b) B
- (c) A
- (d) D
- (e) E

**Q21.** Which of the following is the **fourth sentence** after rearrangement?

- (a) A
- (b) C
- (c) D
- (d) E
- (e) B

**Q22.** In the following question, four sentences are given, out of which only one is incorrect. Identify the incorrect sentence and mark it as the answer. If all the given sentences are correct, then mark **“All are correct”** as the answer.

- (a) After the final whistle, the crowd erupted in cheers and waved their flags with joy.
- (b) She is not only talented in painting but also skilled in writing poetry.
- (c) The manager along with his assistants were attending the annual conference in Delhi.
- (d) To master a new language requires both patience and consistent effort.
- (e) All are correct

**Q23. In the following question, four sentences are given, out of which only one is incorrect. Identify the incorrect sentence and mark it as the answer. If all the given sentences are correct, then mark "All are correct" as the answer.**

- (a) Neither the board members nor the CEO was willing to compromise on the merger terms.
- (b) They were praised both for finishing the project early and for demonstrating leadership under pressure.
- (c) By the time the presentation began, most attendees had already found their seats and settled in.
- (d) He avoided to speak during the meeting, fearing he might say something inappropriate.
- (e) All are correct

**Q24. In the question below, four sentences have been given. Out of four sentences, one sentence is error-free. Find out which of the following sentence is error-free. If all the given sentences have errors, then choose option 'None is correct' as the answer choice.**

- (a) Every student and teacher in the remote village have received the updated course material from the department last week.
- (b) She insisted to speak with the manager directly, despite the receptionist's refusal to allow her through.
- (c) He was determined in overcoming his fear of public speaking before the regional debate.
- (d) If the team finished the proposal on time, the client will approve the next phase by Friday.
- (e) None is correct

**Q25. In the question below, four sentences have been given. Out of four sentences, one sentence is error-free. Find out which of the following sentence is error-free. If all the given sentences have errors, then choose option 'None is correct' as the answer choice.**

- (a) The hikers had began their journey at dawn and hoped to reach the summit by evening without any major delays.
- (b) The charity event was postponed due to the weather conditions being deteriorate rapidly.
- (c) After hours of negotiation, the deal fell through, disappointing both parties.
- (d) Between cooking dinner and to helping the kids with homework, she barely had time to relax.
- (e) None is correct

**Q26. The following question contains a sentence which has been divided into five parts which might not be in their correct order of narrative. The sentence is then followed by five options, one of which gives the sequence of the rearranged parts to make the sentence meaningful. Choose the option which gives the correct sequence of the parts. If the sentence is already arranged in the correct sequence, then mark option " No rearrangement required " as the answer.**

- (A) spending and investment,
  - (B) slowing growth due to less
  - (C) borrowing becomes costly,
  - (D) when interest rates stay high,
  - (E) causing recession
- (a) ABDCE
  - (b) CABDE
  - (c) DCBAE
  - (d) BDCAE
  - (e) No rearrangement required

**Q27. The following question contains a sentence which has been divided into five parts which might not be in their correct order of narrative. The sentence is then followed by five options, one of which gives the sequence of the rearranged parts to make the sentence meaningful. Choose the option which gives the correct sequence of the parts. If the sentence is already arranged in the correct sequence, then mark option " No rearrangement required " as the answer.**

- (A) integrating resilience training
  - (B) youth mental health by
  - (C) the education ministry
  - (D) initiative to address
  - (E) announced a nationwide
- (a) CEDBA
  - (b) DEABC
  - (c) ECBDA
  - (d) ABDCE
  - (e) No rearrangement required

**Q28. The following question contains a sentence which has been divided into five parts which might not be in their correct order of narrative. The sentence is then followed by five options, one of which gives the sequence of the rearranged parts to make the sentence meaningful. Choose the option which gives the correct sequence of the parts. If the sentence is already arranged in the correct sequence, then mark option " No rearrangement required " as the answer.**

- (A) researchers used
  - (B) satellite data to identify
  - (C) signaling global warming
  - (D) rising ocean temperatures,
  - (E) and extreme weather
- (a) ACBDE
  - (b) ACBED
  - (c) CABDE
  - (d) ABDCE
  - (e) No rearrangement required

**Q29. The following question contains a sentence which has been divided into five parts which might not be in their correct order of narrative. The sentence is then followed by five options, one of which gives the sequence of the rearranged parts to make the sentence meaningful. Choose the option which gives the correct sequence of the parts. If the sentence is already arranged in the correct sequence, then mark option " No rearrangement required " as the answer.**

- (A) as the international community
- (B) were displaced
- (C) following border violence, thousands
- (D) urged aid
- (E) and safe passage



- (a) CBADE
- (b) ACBDE
- (c) BCADE
- (d) CABDE
- (e) ABCDE

**Directions (30-35):** In the following paragraph there are letters like (A), (B), (C), (D), (E), (F) given in the sentence. For each letter, five options are given. Choose the most appropriate word from the options that fits the place denoted by the letter appropriately.

Over the past decade, social media influencers have emerged as powerful figures in digital marketing. Unlike traditional celebrities, influencers often cultivate niche audiences that deeply (A) \_\_\_\_\_ with their content. As their followings expand, many of them (B) \_\_\_\_\_ able to convert their personal brands into full-fledged businesses.

Brands now recognize the unique ability of influencers to drive engagement and conversions. Rather than relying solely on generic advertisements, companies partner with influencers to deliver messages that feel more (C) \_\_\_\_\_ and trustworthy. These collaborations, when executed well, can lead to a significant (D) \_\_\_\_\_ in both brand visibility and consumer trust.

However, it is crucial that influencers maintain authenticity. If followers sense that content is overly commercialized, the influencer's credibility (E) \_\_\_\_\_, thereby affecting the effectiveness of the partnership. For this reason, many successful influencers (F) \_\_\_\_\_ been trying to strike a balance between sponsored content and genuine storytelling.

**Q30. Select the correct option to fill in the blank A.**

- (a) resonates
- (b) resonated
- (c) resonate
- (d) has resonated
- (e) was resonating

**Q31. Select the correct option to fill in the blank B.**

- (a) was
- (b) were
- (c) have been
- (d) had
- (e) is

**Q32. Select the correct option to fill in the blank C.**

- (a) contrived
- (b) organic
- (c) fabricated
- (d) exaggerated
- (e) curated

**Q33. Select the correct option to fill in the blank D.**

- (a) polarize
- (b) surge
- (c) relinquish
- (d) intervene
- (e) vacuum

**Q34. Select the correct option to fill in the blank E.**

- (a) have eroded
- (b) had eroded
- (c) was eroding
- (d) were eroding
- (e) erodes

**Q35. Select the correct option to fill in the blank F.**

- (a) have
- (b) has
- (c) had
- (d) is
- (e) were

**Directions (36-40): Which of the following phrases given below the sentence should replace the phrase printed in bold letters to make the sentence grammatically correct? Choose the best option among the five given alternatives that reflect the correct use of phrase in the context of the grammatically correct sentence. If the sentence is correct as it is, mark "No correction required" as the answer.**

**Q36.** The conclusion of the research paper **was aligned on the expert panel's** final recommendations.

- (a) were aligned on the expert panel's
- (b) has been aligned from the expert panel's
- (c) was aligned with the expert panel's
- (d) is aligned to the expert panel's
- (e) No correction required

**Q37.** The balloon **exploded the loud noise**, causing a brief panic among the children.

- (a) exploded to the loud noise
- (b) explodes into the loud noise
- (c) explode in the loud noise
- (d) exploded with a loud noise
- (e) No correction required

**Q38.** She **had wrote multiple drafts** before submitting the final version of her thesis.

- (a) have been written multiple drafts
- (b) has wrote multiple drafts
- (c) had written multiple drafts
- (d) have written multiple drafts
- (e) No correction required

**Q39.** The initial excitement around the product launch **bog down** after the company failed to meet customer expectations.

- (a) panned out
- (b) zeroed in on
- (c) drummed up
- (d) fizzled out
- (e) No correction required

**Q40.** If the team **would have followed** the instructions carefully, they might have avoided the system crash.

- (a) would have follow
- (b) had followed
- (c) would followed
- (d) should have followed
- (e) No correction required

**Directions (41-45):** The table shows the total books (fiction + non - fiction) sold by five shopkeepers. Read the table and answer the following questions given below.

Shopkeepers	Total books	Non-fiction books
<b>A</b>	210	8/13 of total fiction book
<b>B</b>	760	378 less than total fiction books
<b>C</b>	360	120
<b>D</b>	495	5/9 of total books
<b>E</b>	560	14.28% of total books

**Q41.** 20% of the non-fiction books sold by C at the rate of Rs.25 and rest sold at Rs 20. Find the revenue (in Rs) generated by C after selling all the non-fiction books.

- (a) 2520
- (b) 2550
- (c) 2552
- (d) 2555
- (e) 2345

**Q42. Find the ratio of non-fiction books sold by C and fiction book sold by A together to total books sold by C and E together.**

- (a) 25:91
- (b) 25:92
- (c) 25:52
- (d) 25:51
- (e) 23:45

**Q43. Find the average number of fiction books sold by A and E is what percentage of fiction books sold by D and A (Approx).**

- (a) 81%
- (b) 87%
- (c) 69%
- (d) 78%
- (e) 95%

**Q44. 14.28% of total books sold by E are defective and out of that 20% are non-fiction books. Find the defective fiction books sold by E is how many more/less than total books sold by C.**

- (a) 220
- (b) 250
- (c) 296
- (d) 255
- (e) 246

**Q45. If the ratio of total books sold by Z to total fictional book sold by A is 23:13. 30% of books sold by Z are fictional. Find the non-fiction book sold by Z.**

- (a) 120
- (b) 150
- (c) 112
- (d) 161
- (e) 245

Directions (46-50): The graph given below shows the total number of vehicles (cars + bikes) and total number of bikes in five different showrooms. Read the graph and answer the following question.

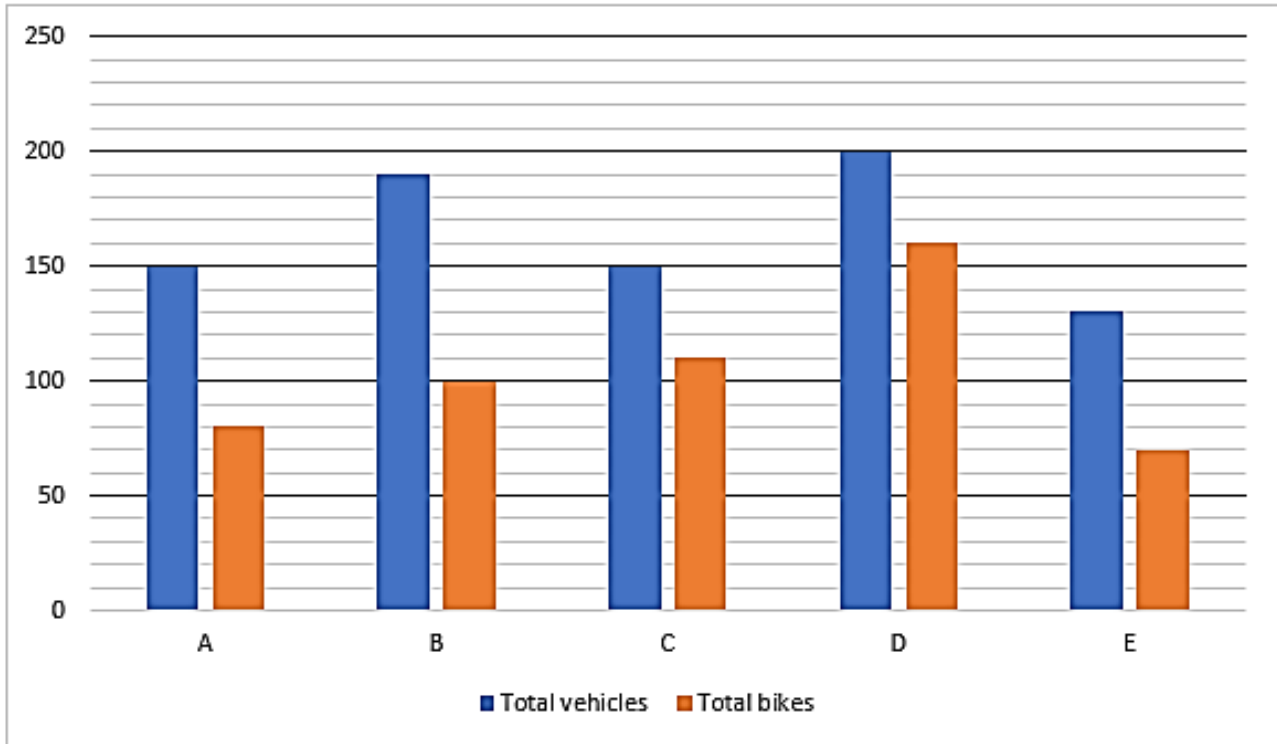

Q46. In shop F, total number of bikes are 25% more than the cars in E and total number of vehicles are average number of vehicles in A and B. Find the cars in F is what percentage more/less than bikes in B.

- (a) 10%
- (b) 5%
- (c) 12%
- (d) 6%
- (e) 4.5%

Q47. Find the difference between average number of cars in A and B and average number of bikes in C and E.

- (a) 10
- (b) 5
- (c) 20
- (d) 6
- (e) 15

**Q48. The ratio of sold to unsold bikes in D is 3:1 and number of unsold bikes in D is 20% less than cars sold by B. Find the unsold cars in B.**

- (a) 50
- (b) 40
- (c) 20
- (d) 60
- (e) 45

**Q49. The cars booked online in A is 60 and rest booked offline. 20% of bikes books online in A. find the difference between vehicles booked online and offline.**

- (a) 1
- (b) 2
- (c) 3
- (d) 4
- (e) 5

**Q50. If defective cars in D is  $\frac{1}{8}$  of total bikes in A and non - defective bike in D is  $\frac{1}{2}$  of the non-defective cars in D. find the total defective vehicles in D.**

- (a) 155
- (b) 150
- (c) 112
- (d) 161
- (e) 245

**Directions (51-55): Read the information and answer the following questions.**

There are three shops (A, B & C) sold wired and wireless chargers. The wired charger sold by A is  $10x$  and the ratio of wired charger to wireless chargers in A is 10:9. Total number of wireless chargers in all the shops is 146. B sold  $(12.5x + 10)$  wireless chargers whereas shop C sold 10 wireless chargers less than that of B. Total chargers sold by B and C is 125 and 167 respectively.

**Q51. Find the ratio of wireless chargers sold by B to wired charges sold by A .**

- (a) 5:1
- (b) 3:2
- (c) 1:2
- (d) 2:3
- (e) 4:5

**Q52. Find the difference between total chargers sold by A and B.**

- (a) 21
- (b) 49
- (c) 20
- (d) 60
- (e) 45

**Q53. Find the sum of total chargers sold by B and wired chargers sold by A.**

- (a) 155
- (b) 165
- (c) 125
- (d) 160
- (e) 145

**Q54. Shop D sold 20% more chargers than that of B and ratio of wired to wireless chargers is 2:1. Find difference between wire chargers sold by D and wireless chargers sold by A.**

- (a) 50
- (b) 40
- (c) 64
- (d) 60
- (e) 45

**Q55. The cost of each wired chargers is Rs 20 and 10% profit earned by selling them. Find the total profit earned by A and B by selling wired chargers (in Rs).**

- (a) 210
- (b) 140
- (c) 120
- (d) 160
- (e) 145

**Q56. Set A contains three consecutive multiples of 7, and set B contains five consecutive odd numbers. The largest number in set A is equal to the smallest number in set B. If the average of the smallest number in sets A and B is 28, then find the difference between the 2nd smallest number in set A and the 2nd largest number in set B.**

- (a) 11
- (b) 9
- (c) 13
- (d) 15
- (e) 21

**Directions (57-58):** The following questions are accompanied by two statements i.e. statement (I) and statement (II). You have to determine which statement (s) is/are sufficient/necessary to answer the questions.

**Q57. If the LCM of 16, X and 40 is 160, then find which of the statement is /are sufficient to find the exact value of X.**

I. X is an even number

II. X is multiple of 5.

- (a) Neither statement (I) nor statement (II) by itself is sufficient to answer the question.
- (b) Statement (II) alone is sufficient to answer the question but statement (I) alone is not sufficient to answer the question.
- (c) Either statement (I) or statement (II) by itself is sufficient to answer the question.
- (d) Both the statements taken together are necessary to answer the questions, but neither of the statements alone is sufficient to answer the question.
- (e) Statement (I) alone is sufficient to answer the question but statement (II) alone is not sufficient to answer the questions.

**Q58. Find the length of the train B.**

I. The length of train A is the same as the length of train B.

II. The train A can cross a pole in 10 seconds, and the train can cross a 150-meter-long platform in 17.5 seconds.

- (a) Neither statement (I) nor statement (II) by itself is sufficient to answer the question.
- (b) Statement (II) alone is sufficient to answer the question but statement (I) alone is not sufficient to answer the question.
- (c) Either statement (I) or statement (II) by itself is sufficient to answer the question.
- (d) Both the statements taken together are necessary to answer the questions, but neither of the statements alone is sufficient to answer the question.
- (e) Statement (I) alone is sufficient to answer the question but statement (II) alone is not sufficient to answer the questions.

**Q59. A spend 25% of his monthly income on groceries and 20% of the remaining on rent, and the remaining amount he spends on EMI, clothes, and savings is in the ratio of 1:3:6, respectively. If the difference between the amount spent on rent and clothes is Rs 570, then find the monthly income of A (in Rs)**

- (a) 14000
- (b) 12000
- (c) 19000
- (d) 15000
- (e) 11000



**Q60.** A shopkeeper marked the article 50% above its cost price and allowed a 20% discount. He earned Rs 40 profit. If he allowed a 25% discount on the article, then find the profit he earned (in Rs).

- (a) 40
- (b) 50
- (c) 25
- (d) 10
- (e) 5

**Q61.** Seven years ago, the ratio of the age of A to B years ago was 5:3. The ratio of the age of A four years hence and B three years hence will be 36:25. Find the present age of B (in years).

- (a) 22
- (b) 28
- (c) 25
- (d) 20
- (e) 16

**Q62.** The average weight of 12 boys and X girls is 15 kg and 10 kg respectively. If the average weight of boys and girls is 12.4 kg, then find X.

- (a) 19
- (b) 15
- (c) 10
- (d) 12
- (e) 13

**Q63.** Rachit and Varun started a business with a combined investment of Rs 18000. After six months, Rachit withdrew Rs 2000, and at the end of the year, the profit share of Rachit is Rs 2200 out of the total profit of Rs 3400. Find the initial investment of Rachit (in Rs).

- (a) 4500
- (b) 11000
- (c) 6000
- (d) 12000
- (e) None of these

**Q64.** X men can complete a work in 15 days, and  $3X/4$  women can complete the same work in 12 days. 5 men and 6 women can complete the work in 12 days. Find the time taken (in days) by 8 men to complete the work.

- (a) 19.5
- (b) 21
- (c) 22.5
- (d) 20
- (e) 24.5

**Q65.** The ratio of milk to water in a vessel is 5:3 respectively. If 32 liters of mixture are taken out and 4 liters of water are added to the mixture, then the ratio of milk to water becomes 3:2. Find the initial quantity of the mixture.

- (a) 80 liters
- (b) 112 liters
- (c) 128 liters
- (d) 98 liters
- (e) 64 liters

**Q66.** A man invested Rs X in compound interest at 20% p.a. for two years, and he invested the same amount in simple interest for three years at 21% p.a. If the difference between the interest is Rs 1900, then find X.

- (a) 10000
- (b) 12000
- (c) 14000
- (d) 8000
- (e) 15000

**Q67.** The perimeter of a rectangle B is 30% of the perimeter of a rectangle A. The breadth and length of the rectangle A are 16 cm and 24 cm, respectively. If the length of rectangle B is 1/3rd that of rectangle A, then find the area of rectangle B (in sq. cm).

- (a) 8
- (b) 16
- (c) 24
- (d) 32
- (e) None of these

**Directions (68-70):** In each of these questions, two equation (I) and (II) are given. You have to solve both the equations and give answer.

**Q68.** I.  $x^2 - 18x + 65 = 0$

II.  $y^2 - 29y + 208 = 0$

- (a) If  $x > y$
- (b) If  $x \geq y$
- (c) If  $x < y$
- (d) If  $x \leq y$
- (e) If  $x = y$  or no relation can be established between x and y

**Q69.** I.  $x^2 - 15x + 50 = 0$

II.  $y^2 - 12y + 35 = 0$

- (a) If  $x > y$
- (b) If  $x \geq y$
- (c) If  $x < y$
- (d) If  $x \leq y$
- (e) If  $x = y$  or no relation can be established between  $x$  and  $y$

**Q70.** I.  $x^2 - 14x + 49 = 0$

II.  $y^2 - 10y + 21 = 0$

- (a) If  $x > y$
- (b) If  $x \geq y$
- (c) If  $x < y$
- (d) If  $x \leq y$
- (e) If  $x = y$  or no relation can be established between  $x$  and  $y$

**Directions (71-75):** Study the following information carefully and answer the questions given below:

Eight persons – M, P, R, S, T, U, V and W - sit in a row. Some of them are facing north, and some of them are facing south. The number of persons facing north is more than the number of persons facing south.

T sits fourth to the right of W. Four persons sit between M and W. R sits second to the right of T. More than two persons sit between W and R. Both the immediate neighbours of M face opposite direction to each other. U sits immediate left of R. S sits fourth to the right of M. Immediate neighbours of S face the same direction. V and P sits immediate right of each other. P doesn't face in the north direction. The persons who sit at the extreme ends face the opposite direction to each other.

**Q71.** Who among the following persons sits fourth to the right of P?

- (a) U
- (b) M
- (c) S
- (d) T
- (e) R

**Q72.** Which among the following statement is/are false?

- (a) W sits at one of the extreme ends of the row.
- (b) T and V are immediate neighbours to each other
- (c) Only one person sits between U and M.
- (d) T sits fourth to the right of U.
- (e) P and M face opposite directions.

**Q73. If P and U interchange their positions, then who will sit third to the right of P?**

- (a) M
- (b) W
- (c) S
- (d) T
- (e) V

**Q74. Which of the following pairs represents the persons face the same direction?**

- (a) S and T
- (b) U and W
- (c) P and S
- (d) T and M
- (e) R and S

**Q75. What is the position of U with respect to P?**

- (a) Third to the right
- (b) Fourth to the left
- (c) Fifth to the right
- (d) Third to the left
- (e) Fifth to the left

**Directions (76-80): Study the following information carefully and answer the questions given below:**

Eight persons - A, B, C, D, E, F, G and H sit around a square-shaped table in such a way that four of them sit at four corners of the table and face inside while the remaining four sit at the middle of the four sides and face outside, but not necessarily in the same order. Each person likes different colours – Grey, Orange, Red, White, Black, Blue, Green and Yellow

The one who sits fifth to the right of G likes white colour. One person sits between the ones who like white colour and black colour. D sits immediately to the right of G. The one who likes black colour is not an immediate neighbour of G but sits third to the left of B. B sits opposite to E who likes grey colour. A sits second to the right of E. H sits second to the right of the one who likes Orange colour. H doesn't like white colour. The one who sits immediate right of H likes blue colour. C sits second to the right of F but doesn't sit opposite to the one who likes Red colour and Green colour. G doesn't like Red Colour. The one who likes green colour doesn't sit at the corners.

**Q76. The number of persons sit between A and the one who likes yellow colour when counting from right of A is one more than the number of persons sit between D and \_\_\_ when counting from left of D.**

- (a) The one who likes grey colour
- (b) The one who likes orange colour
- (c) The one who likes white colour
- (d) The one who likes Black colour
- (e) The one who likes green colour

**Q77. What is the position of E with respect to the one who likes green colour?**

- (a) Third to the left
- (b) Second to the left
- (c) Third to the right
- (d) Fourth to the right
- (e) Second to the right

**Q78. How many persons sit between D and B when counted from the left of D?**

- (a) Four
- (b) Three
- (c) Five
- (d) Six
- (e) Two

**Q79. Four of the following five are alike in a certain way and thus form a group. Find the one who doesn't belong to the group.**

- (a) The one who likes Black colour
- (b) A
- (c) F
- (d) The one who likes yellow colour
- (e) D

**Q80. Which among the following statement(s) is/are true?**

- I. G sits second to the left of the one who likes White colour.
- II. A sits opposite to the one who likes green colour.
- III. Two persons sit between H and E when counting from the left of H.

- (a) Only I
- (b) Only III
- (c) Only II
- (d) Both II and III
- (e) All I, II, and III

**Q81. In the word 'NATURALLY', how many pairs of the letters have the same number of letters between them (both forward and backward direction) as in the English alphabet?**

- (a) Four
- (b) Two
- (c) One
- (d) Three
- (e) More than four

**Directions (82-86): Study the following information carefully and answer the questions given below:**

Nine persons—A, B, C, D, E, F, G, H, and I—are working in a company at different designations such as CEO, Manager, HR, Supervisor, Team Lead, Executive, Accountant, Clerk, and Peon, but not necessarily in the same order. The designations are given in descending order, such that CEO is the senior-most and Peon is the junior-most designation.

D is four designations senior to G. G is designated immediately senior to B who is not peon. Two persons are designated between A and E. E is senior to A. F is designated junior to A but not immediately junior. F is not designated as the junior most person. I is designated senior to C and H. I is not designated as HR. H is designated junior to C

**Q82. Who among the following is designated as Executive?**

- (a) G
- (b) The person who is two persons senior to B
- (c) A
- (d) C
- (e) The person who is four persons junior to A

**Q83. How many persons are designated between I and the one who is immediately junior to F?**

- (a) One
- (b) Five
- (c) Four
- (d) Three
- (e) Two

**Q84. If all the persons are designated in alphabetical order from seniormost to juniormost designation, then the position of how many persons remains the same?**

- (a) Two
- (b) Four
- (c) One
- (d) Three
- (e) More than four

**Q85. Which among the following statement(s) is/are true?**

- (a) I is senior to C
- (b) C is not designated as Accountant
- (c) More than four persons are designated senior to H
- (d) C is designated immediately senior to F.
- (e) All are true

**Q86. Which among the following combination is not correct?**

- (a) I - Manager
- (b) H - Peon
- (c) E - CEO
- (d) D - Team Lead
- (e) F - Executive

**Q87. In the number '278531519', the digits which are greater than 6 are subtracted by 1 and the digits which are less than 6 are added by 1. Then, all the repeating digits are eliminated from the number. Now, what will be the sum of all the odd digits of the new number formed after rearrangement?**

- (a) 12
- (b) 10
- (c) 6
- (d) 8
- (e) 14

**Directions (88-92): Study the following information carefully and answer the questions given below:**

Seven persons – D, E, F, G, H, J and K go to purchase different fruits on seven different days of a week starting from Monday to Sunday, but not necessarily in the same order. The different fruits are- Apple, Mango, Guava, Litchi, Pear, Orange and Grape.

E goes to purchase fruit immediately before J. Three persons purchase fruits between J and the one who purchased Litchi. J purchased fruit before the one who purchased litchi. The number of persons go to purchase fruit after E is same as the number of persons go to purchase fruit before K who purchased Pear. Three persons go to purchase fruit between K and the one who purchase Guava. The one who go to purchase guava purchased it two persons before H. D purchased Orange. D purchased the fruit after J. As many persons purchased between the ones who purchased Orange and Mango as between Mango and G. Apple was purchased before Grape but not immediately before.

**Q88. Which among the following combination is/are correct?**

- (a) J - Litchi
- (b) K - Grape
- (c) G- Apple
- (d) E- Mango
- (e) All are correct

**Q89. If G is related to Guava and in the same way D is related to Pear then who among the following is related to Litchi?**

- (a) H
- (b) E
- (c) G
- (d) K
- (e) J

**Q90. How many persons purchase fruits between E and the one who purchased Litchi?**

- (a) Three
- (b) Four
- (c) Five
- (d) Two
- (e) One

**Q91. Who purchased fruit on Saturday?**

- (a) R
- (b) K
- (c) G
- (d) E
- (e) J

**Q92. E purchased which fruit?**

- (a) Mango
- (b) Apple
- (c) Guava
- (d) Grape
- (e) Litchi



**Directions (93-95): In these questions, the relationship between different elements is shown in the statements. The statements are followed by two conclusions. Study the conclusions based on the given statements and select the appropriate answer:**

**Q93. Statements:**  $U \geq V < W > X > Y \geq F, Y = Z \geq E > M$

**Conclusions:**

I.  $M < W$

II.  $Z > V$

- (a) If only conclusion I is true
- (b) If only conclusion II is true
- (c) If either conclusion I or II is true
- (d) If both conclusions I and II are true
- (e) If neither conclusion I nor II is true



**Q94. Statements:**  $L = M \leq N \leq O = P, J > K = L > Q; X = Y \geq J$

**Conclusions:**

I.  $X > L$

II.  $P \geq Q$

- (a) If only conclusion I is true
- (b) If only conclusion II is true
- (c) If either conclusion I or II is true
- (d) If both conclusions I and II are true
- (e) If neither conclusion I nor II is true

**Q95. Statements:**  $P \leq Q > S < M = T, U \geq V < W > S$

**Conclusions:**

I.  $T < W$

II.  $W \leq M$

- (a) If only conclusion I is true
- (b) If only conclusion II is true
- (c) If either conclusion I or II is true
- (d) If both conclusions I and II are true
- (e) If neither conclusion I nor II is true

**Directions (96-100): Read the given information carefully and answer the related questions:**

Nine boxes are placed one above the other in a stack. Five boxes are placed between box G and box A. Box D is placed two boxes below box A. Number of boxes placed between box D and box G is three more than the number of boxes placed below box H. One box is placed between box H and box C. Box F is placed five boxes above box I. Box B is not placed above box E.

**Q96. What is the position of box B from top of the stack?**

- (a) Sixth
- (b) Fifth
- (c) Fourth
- (d) Third
- (e) Seventh

**Q97. How many boxes are placed between box E and box H?**

- (a) Two
- (b) Three
- (c) Four
- (d) Five
- (e) Six

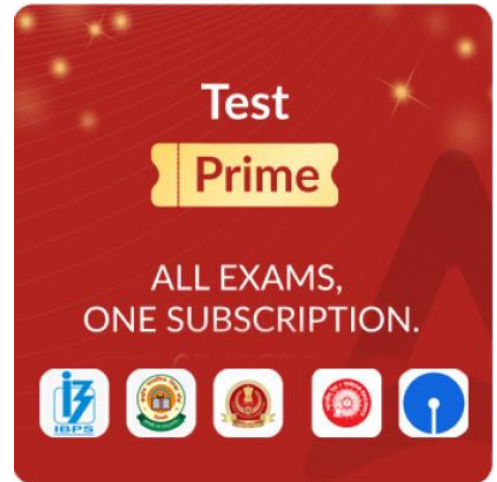

**Q98. The number of boxes placed above box D is same as the number of boxes placed below \_\_\_\_.**

- (a) Box I
- (b) Box C
- (c) Box G
- (d) Box F
- (e) Box E

**Q99. Four of the following five are similar in a certain manner and related to a group, which pair is not related to the group?**

- (a) F-A
- (b) E-D
- (c) B-I
- (d) C-G
- (e) A-H

**Q100. Which of the following statement is correct?**

- I. Two boxes are placed above box A
- II. Box F is placed above box D
- III. Box I and H are adjacent boxes

- (a) Only III
- (b) Only I
- (c) Only II
- (d) All I, II, III
- (e) Only I and II

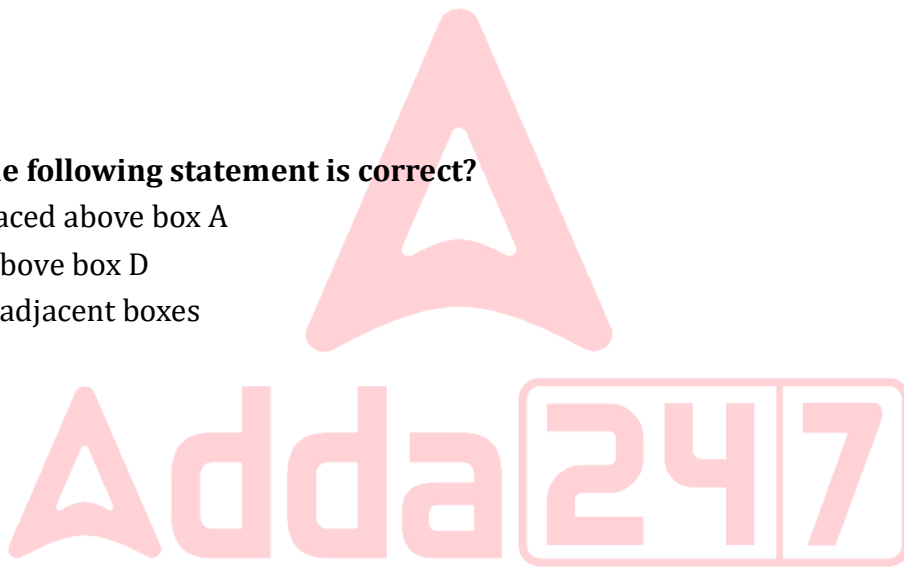

## Solutions

**S1. Ans.(d)**

**Sol.** The word "**sustain**" means to support, maintain, or endure something over time.

- **(I) Correct** – The bridge **sustaining** weight means it is supporting it, which is a correct use of the word.
- **(II) Incorrect** – "Sustain an argument" is not a commonly used phrase. The better expression would be "**support an argument**" with evidence.
- **(III) Correct** – "Sustain a career" meaning to maintain or continue a career is an appropriate use of the word.

Thus, the correct answer is **D) Both I and III.**

### S2. Ans.(b)

**Sol.** The word "idol" refers to **a person who is greatly admired or a statue/image worshipped as a deity.**

- **(I) Correct** – "Idol" can mean a person who is admired or looked up to, making this usage appropriate.
- **(II) Correct** – An **idol** can also refer to a religious statue or image, which fits this context.
- **(III) Incorrect** – While he is respected, the word "**role model**" or "**inspiration**" would be more suitable in a professional setting rather than "idol," which carries a stronger connotation of admiration or worship.

Thus, the correct answer is **B) Both I and II.**

### S3. Ans.(b)

**Sol.** The village elder spoke with quiet \_\_\_\_\_, and though his words were few, they carried a weight that seemed to \_\_\_\_\_ through the crowd.

**Correct Answer: (b) authority, ripple**

**Explanation:**

- **Authority** = the power to influence or command; fits with "quiet" and respected speech.
- **Ripple** = to spread gradually in small waves; conveys the subtle but spreading effect of his words.

**Other Options:**

- **Arrogance** = overbearing pride - too negative for "quiet" tone.
- **Drift** = to move aimlessly - lacks impact.
- **Timidity** = lack of courage/confidence - unlikely to carry "weight".
- **Vanish** = disappear - doesn't convey spread or influence.
- **Humor** = amusement or fun - mismatched tone with "weight".
- **Meander** = to wander aimlessly - not impactful.
- **Vigor** = physical strength/force - doesn't fit with "quiet".
- **Echo** = repeated sound - less precise than "ripple" in emotional context.

### S4. Ans.(e)

**Sol.** Even in the face of relentless failure, her spirit remained \_\_\_\_\_, and her unwavering focus began to \_\_\_\_\_ those who had once doubted her.

**Correct Answer: (e) tenacious, inspire**

**Explanation:**

- **Tenacious** = persistent, determined; fits with "unwavering spirit".
- **Inspire** = to motivate or uplift others; fits positive transformation of doubters.

**Other Options:**

- **Fragile** = easily broken - contradicts "unwavering".
- **Dismiss** = to reject - illogical outcome.
- **Apathetic** = showing no interest - doesn't match "focus".
- **Alienate** = to isolate others - opposite of inspiring.
- **Wavering** = fluctuating/uncertain - contradicts "unwavering".
- **Confuse** = does not show empowerment.
- **Mellow** = relaxed/gentle - doesn't show strength or drive.
- **Silence** = to stop from speaking - irrelevant outcome.

**S5. Ans.(b)**

**Sol.** The castle stood in \_\_\_\_\_ silence under the moonlight, its broken towers and cracked stones a silent \_\_\_\_\_ to forgotten wars.

**Correct Answer: (b) ominous, testament**

**Explanation:**

- **Ominous** = giving a sense of dread or warning; fits with moonlit, broken castle.
- **Testament** = proof or evidence of something; fits "silent tribute" to past.

**Other Options:**

- **Giddy** = dizzy or silly - opposite of mood.
- **Tribute** = praise or honor - not silent or warlike.
- **Joyful** = happy - wrong tone.
- **Narrative** = a story - doesn't capture the silent presence.
- **Rustic** = rural/simplistic - doesn't match tone of "war".
- **Spectacles** = visually striking display - plural, and doesn't fit "silent".
- **Glorious** = splendid/celebratory - tone mismatch.
- **Monumental** = massive/important - needs noun not adjective here.

**S6. Ans.(d)**

**Sol.** As the final notes of the symphony faded, a deep \_\_\_\_\_ filled the concert hall, leaving the audience to \_\_\_\_\_ in quiet awe.

**Correct Answer: (d) resonance, linger**

**Explanation:**

- **Resonance** = deep, lasting sound or feeling; perfect for fading music.
- **Linger** = to remain or stay for a while; matches "quiet awe".

**Other Options:**

- **Uproar** = loud disturbance - contradicts "quiet awe".
- **Fidget** = to move restlessly - wrong tone.
- **Humdrum** = boring/repetitive - not fitting for a symphony.
- **Scatter** = to disperse - contradicts the idea of staying.
- **Discord** = harsh or jarring sound - not suitable after a symphony.
- **Erupt** = sudden noise/reaction - tone mismatch.
- **Blare** = loud harsh sound - not soft/ending.
- **Jolt** = sudden shock - doesn't align with "awe".

**S7. Ans.(b)**

**Sol.** The journalist's report was both \_\_\_\_\_ and revealing, managing to \_\_\_\_\_ even the most well-guarded aspects of the scandal.

**Correct Answer: (b) insightful, uncover**

**Explanation:**

- **Insightful** = showing deep understanding; complements "revealing".
- **Uncover** = to expose or bring to light; matches context of scandal.

---

**Other Options:**

- **Calculation** = Incorrect both grammatically and contextually.
- **Observe** = neutral; doesn't convey exposure.
- **Biased** = unfair/prejudiced - undermines "revealing".
- **Interrupt** = to break flow - irrelevant.
- **Redundant** = repetitive - not effective reporting.
- **Simplify** = to make easier - doesn't match exposing hidden truths.
- **Vague** = unclear - doesn't fit with "revealing".
- **Uncovering** = verb form not grammatically correct after "to".

**S8. Ans.(d)**

**Sol. Statement (I) is correct.** The passage states that pigeon populations have grown significantly **due to human feeding and lack of natural predators**, which can be categorized under human intervention and favorable conditions. ("Studies indicate that pigeon populations in major cities have increased by over 30% in the past decade, largely due to human feeding habits and the lack of natural predators.")

**Statement (II) is incorrect.** While the passage does mention that **pigeon droppings contain over 60 types of pathogens**, it does **not** state that the **CDC has classified them as hazardous biological waste**. This is an extrapolation beyond the provided information. ("Research from the Centers for Disease Control and Prevention (CDC) states that pigeon droppings contain over 60 types of pathogens.")

**Statement (III) is correct.** The passage mentions that **legal measures (fines) and physical deterrents (spikes, netting, bird-repelling devices) have led to reductions in pigeon populations**. ("Some regions, like Venice and Singapore, have introduced fines for feeding pigeons, leading to a 25% reduction in pigeon numbers over five years.")

**S9. Ans.(a)**

**Sol. Statement (I) is incorrect.** The passage does **not** mention that pigeons are resistant to deterrents like spikes and netting. In fact, **it states that cities are successfully using these measures to reduce pigeon presence**. ("Many cities have started implementing deterrent measures such as installing anti-roosting spikes, netting, and automated bird-repelling devices.")

**Statement (II) is correct.** The passage mentions that **cities imposing fines for feeding pigeons have seen a 25% reduction in pigeon numbers**, making this statement valid. ("Some regions, like Venice and Singapore, have introduced fines for feeding pigeons, leading to a 25% reduction in pigeon numbers over five years.")

**Statement (III) is correct.** The passage states that **pigeon droppings are acidic and cause the gradual erosion of buildings and infrastructure**, confirming that they pose a structural threat. ("Pigeon droppings are highly acidic, leading to the gradual erosion of buildings, monuments, and infrastructure.")

**S10. Ans.(b)**

**Sol. Statement (I) is correct.** The passage explicitly states that pigeon droppings are acidic, leading to infrastructure erosion and sanitation issues. ("Pigeon droppings are highly acidic, leading to the gradual erosion of buildings, monuments, and infrastructure.")

**Statement (II) is incorrect.** The passage mentions that a study in Barcelona found **70%** of pigeons carried ectoparasites, **not nearly all**. The wording "nearly all" is an exaggeration and makes this statement false. ("A study conducted in Barcelona in 2022 found that 70% of pigeons carried ectoparasites.")

**Statement (III) is incorrect.** The passage states that **pigeon presence increases airborne allergens, worsening conditions for individuals with asthma or respiratory issues**, proving a direct impact. ("Furthermore, their presence in large numbers contributes to increased airborne allergens, worsening conditions for people with asthma or respiratory issues.")

**S11. Ans.(d)**

**Sol.** In the passage, "**battery**" is used metaphorically in "**The unchecked growth of pigeon populations is like a battery of problems waiting to explode.**"

Here, "**battery**" means **a series or collection of related issues**, making "**series**" the best choice.

"**Power source**" refers to electrical batteries, which is incorrect.

"**Assault**" is another meaning of battery (legal term) but does not fit the passage's context.

"**Explosion**" is related to the phrase but does not mean "battery."

**S12. Ans.(c)**

**Sol.** In the passage, "**If we do not take preventive measures, we might find ourselves caught in a thread of complications that could have been easily avoided.**"

Here, "**thread**" refers to a **chain or sequence** of interconnected events or complications.

"**Fiber**" refers to a literal thread, which is incorrect.

"**Discussion**" (as in an online thread) does not fit the passage's context.

"**Narrative**" and "**link**" are close but do not precisely convey the meaning of a **series of problems**.

**S13. Ans.(c)**

**Sol.** The passage states, "**They build their nests in nooks and corners of our homes, leading to an accumulation of droppings, feathers, and parasites.**"

"**Nooks and corners**" means **hidden or small, unnoticed places**, which correctly fits the context.

"**Heart and soul**" refers to deep passion or dedication, which does not apply here.

"**Nuts and bolts**" refers to the basic details of a process, making it irrelevant.

"**Thick and thin**" means staying together through difficulties, which does not fit.

"**Odds and ends**" refers to small miscellaneous items, not physical spaces.

**S14. Ans.(d)**

**Sol.** The passage states, "**These birds, often seen flocking in public squares, rooftops, and balconies, have adapted remarkably well to city life.**" It later explains that **human feeding and lack of predators are the key reasons**. Option (b) is partly true, but it is **not stated as a primary reason** like option (d).

**S15. Ans.(d)**

**Sol.** The passage states, "Many cities have started implementing deterrent measures such as installing anti-roosting spikes, netting, and automated bird-repelling devices." It also states, "Some regions, like Venice and Singapore, have introduced fines for feeding pigeons." Option (b) and option (c) sound scientific but are **not mentioned in the passage**.

**S16. Ans.(a)**

**Sol.** In the passage, "These birds, often seen flocking in public squares, rooftops, and balconies, have adapted remarkably well to city life."

Here, "adapted" means "adjusted" or "become suited to" a new environment.

"Modified" is close but suggests an intentional change rather than a natural one.

"Created" and "rejected" are completely incorrect.

"Improved" suggests enhancement, which is not the focus of the word "adapted" in this context.

**S17. Ans.(e)**

**Sol.** The correct order is DACEB.

**Final Order: D - A - C - E - B**

1. D - Introduces the topic: advancements in cancer research.
2. A - Contrasts traditional treatments with side effects.
3. C - Introduces precision medicine as a better alternative.
4. E - Raises a problem with the new treatments: high cost.
5. B - Ends on an optimistic note: organizations are acting on the issue.

According to the correct order the **THIRD** sentence is **sentence C**.

**S18. Ans.(d)**

**Sol.** The correct order is DACEB.

**Final Order: D - A - C - E - B**

1. D - Introduces the topic: advancements in cancer research.
2. A - Contrasts traditional treatments with side effects.
3. C - Introduces precision medicine as a better alternative.
4. E - Raises a problem with the new treatments: high cost.
5. B - Ends on an optimistic note: organizations are acting on the issue.

According to the correct order the **FIRST** sentence is **sentence D**.

**S19. Ans.(a)**

**Sol.** The correct order is DACEB.

**Final Order: D - A - C - E - B**

1. D - Introduces the topic: advancements in cancer research.
2. A - Contrasts traditional treatments with side effects.
3. C - Introduces precision medicine as a better alternative.
4. E - Raises a problem with the new treatments: high cost.
5. B - Ends on an optimistic note: organizations are acting on the issue.

According to the correct order the **LAST** sentence is **sentence B**.

**S20. Ans.(c)**

**Sol.** The correct order is DACEB.

**Final Order: D - A - C - E - B**

1. D - Introduces the topic: advancements in cancer research.
2. A - Contrasts traditional treatments with side effects.
3. C - Introduces precision medicine as a better alternative.
4. E - Raises a problem with the new treatments: high cost.
5. B - Ends on an optimistic note: organizations are acting on the issue.

According to the correct order the **SECOND** sentence is **sentence A**.

**S21. Ans.(d)**

**Sol.** The correct order is DACEB.

**Final Order: D - A - C - E - B**

1. D - Introduces the topic: advancements in cancer research.
2. A - Contrasts traditional treatments with side effects.
3. C - Introduces precision medicine as a better alternative.
4. E - Raises a problem with the new treatments: high cost.
5. B - Ends on an optimistic note: organizations are acting on the issue.

According to the correct order the **FOURTH** sentence is **sentence E**.

**S22. Ans.(c)**

**Sol.**

(a)  Correct sentence

"After the final whistle, the crowd erupted in cheers and waved their flags with joy."

✓ Proper sequence of actions, subject-verb agreement is correct.

(b)  Correct sentence

She is not only talented in painting but also skilled in writing poetry.

✓ Parallelism maintained with "not only... but also..."

(c)  Incorrect sentence

"The manager along with his assistants **were** attending the annual conference in Delhi."

✗ Error: Subject-verb agreement.

✓ "The manager" is the subject. "Along with his assistants" is **additional information**, not part of the subject.

✓ Singular subject requires "**was**", not "**were**".

**Corrected:** The manager, along with his assistants, **was** attending the annual conference in Delhi.

(d)  Correct sentence

"To master a new language requires both patience and consistent effort."

✓ "To master" (infinitive phrase) as subject takes singular verb "requires".

**Correct answer: (c)**



S23. Ans.(d)

Sol.

(a)  **Correct sentence**

"Neither the board members nor the CEO was willing to compromise..."

✓ In "neither...nor" constructions, the verb agrees with the subject closest to it → here, "CEO" is singular → "was" is correct.

(b)  **Correct sentence**

"They were praised both for finishing the project early and for demonstrating leadership under pressure."

✓ "both... and..." is used correctly.

✓ Parallel gerund structure: for finishing and for demonstrating.

(c)  **Correct sentence**

"By the time the presentation began, most attendees had already found their seats and settled in."

✓ Past perfect tense ("had found") is correctly used before the simple past ("began").

(d)  **Incorrect sentence**

"He avoided to speak during the meeting..."

✗ Error: The verb "avoid" must be followed by a gerund (-ing form), not an infinitive.

Corrected: He avoided speaking during the meeting...

**Correct answer: (d)**

S24. Ans.(e)

Sol.

(a)  **Subject-verb agreement + tense error**

"Every student and teacher" is treated as **singular** → should be "**has received**"

Also, "last week" suggests **past**, so "**have received**" is awkward.

**Corrected:** Every student and teacher in the remote village received the updated course material from the department last week.

(b)  **Infinitive/gerund error**

"Insisted to speak" is incorrect.

Correct form: "**insisted on speaking**"

**Corrected:** She insisted on speaking with the manager directly...

(c)  **Preposition/gerund error**

"Determined in overcoming" is incorrect.

Correct: "**determined to overcome**"

**Corrected:** He was determined to overcome his fear of public speaking...

(d) In first conditional, the if-clause must be in the simple present tense, and the main clause in the simple future.

Here, "finished" is past tense, which breaks the first conditional structure.

Correct sentence: If the team finishes the proposal on time, the client will approve the next phase by Friday.

**Answer: (e) None is correct**

S25. Ans.(c)

Sol.

(a) ✗ Verb tense error

"had began" is incorrect.

**"Begin" (base) → began (past) → begun (past participle)**

So, with "had", we need **"had begun"**

**Corrected:** The hikers had begun their journey at dawn...

(b) ✗ Verb form error

"being deteriorate" is grammatically wrong.

Should be: **"deteriorating"**

**Corrected:** ...due to the weather conditions deteriorating rapidly.

(c) ✓ Correct sentence

"fell through" is a correct **phrasal verb**, meaning the deal failed or didn't happen.

Tense is appropriate, sentence is complete.

✓ **Correct as is.**

(d) ✗ Gerund/infinitive error

"Between cooking dinner and to helping..." → parallelism error.

Should be: **"between cooking dinner and helping..."**

**Corrected:** Between cooking dinner and helping the kids with homework...

✓ **Answer: (c)**

S26. Ans.(c)

Sol. The correct sequence is DCBAE.

When interest rates stay high, borrowing becomes costly, slowing growth due to less spending and investment, causing recession.

S27. Ans.(a)

Sol. The correct sequence is CEDBA.

The education ministry announced a nationwide initiative to address youth mental health by integrating resilience training.

S28. Ans.(d)

Sol. The correct sequence is ABDCE.

"Researchers used satellite data to identify rising ocean temperatures, signaling global warming and extreme weather."

S29. Ans.(a)

Sol. The correct sequence is CBADE.

Following border violence, thousands were displaced as the international community urged aid and safe passage.

**S30. Ans.(c)**

**Sol.** The sentence states:

*"Unlike traditional celebrities, influencers often cultivate niche audiences that deeply (A) \_\_\_\_\_ with their content."*

- The subject of the verb is "**audiences**" (plural).
- Since "**audiences**" is plural, the verb must be **plural** as well.
- "**Resonate**" (without an "s") is the **plural verb form** that matches the subject.

Thus, the correct answer is **(c) resonate**.

**S31. Ans.(c)**

**Sol.** The sentence uses present perfect context: "many of them \_\_\_ able to convert..."

- The plural subject "many of them" requires "**have been**".
- "Have been able to convert..." implies success over time until the present.
- Correct form: many of them **have been** able to convert...

**S32. Ans.(b)**

**Sol.** The blank describes messages that feel more natural and believable.

- "**Organic**" is the best fit—it means natural, unforced, authentic in marketing.
- Words like "contrived" or "fabricated" have negative or unnatural connotations.
- Correct form: messages that feel more **organic** and trustworthy.

**S33. Ans.(b)**

**Sol.** The sentence: "...can lead to a significant \_\_\_\_\_ in visibility and trust."

- "**Surge**" means a sudden increase and fits perfectly here.
- Other options like "polarize" or "relinquish" do not fit contextually.
- Correct form: a significant **surge** in both brand visibility and consumer trust.

**S34. Ans.(e)**

**Sol.** The clause: "...credibility \_\_\_\_\_, thereby affecting..."

- The sentence requires a verb that describes the ongoing effect of overly commercialized content on credibility.
- "Erodes" is the correct present tense form, indicating a gradual decline in credibility.
- Past forms ("had eroded," "were eroding") don't match the present-tense narrative.
- Correct form: credibility **erodes**, thereby affecting...

**S35. Ans.(a)**

**Sol.** Subject: "influencers" (plural) → requires "have"

- "Have been trying" is present perfect continuous, showing ongoing effort till now, which fits perfectly.
- Correct form: influencers **have** been trying to strike a balance...

**S36. Ans.(c)**

**Sol.** The correct preposition after "aligned" is "with", not "on".

- "Align with" means to agree or be in harmony with something.
- The subject "conclusion" is singular, so "was" is correct.
- **Corrected sentence:** The conclusion of the research paper was aligned **with** the expert panel's final recommendations.

**S37. Ans.(d)**

**Sol.** "Exploded the loud noise" is incorrect because "explode" is an intransitive verb; it does not take a direct object.

- Correct expression: "exploded **with** a loud noise" → describes the **manner** of the explosion.
- **Corrected sentence:** The balloon exploded **with a loud noise**, causing a brief panic among the children.

**S38. Ans.(c)**

**Sol.** "Had wrote" is incorrect.

- After "**had**", we use the **past participle** form.
- Past participle of "write" is "**written**".
- **Corrected sentence:** She had **written** multiple drafts before submitting the final version of her thesis.

**S39. Ans.(d)**

**Sol.** The sentence describes how excitement gradually died down after disappointment.

- "**Fizzled out**" means to **gradually lose strength or fail**, which fits perfectly.
- Other options like "panned out" (succeeded), "zeroed in on" (focused), and "drummed up" (created interest) do not match the context.
- **Corrected sentence:** The initial excitement around the product launch **fizzled out** after the company failed to meet customer expectations.

**S40. Ans.(b)**

**Sol.** This is a third conditional sentence:

- Structure: **If + past perfect** → **would have + past participle**
- "Would have followed" in the **if-clause** is incorrect.
- **Corrected sentence:** If the team **had followed** the instructions carefully, they might have avoided the system crash.

**S41. Ans.(a)**

**Sol.**

**For A,**

Total books = 210

Non - fiction books =  $\frac{8}{13+8} \times 210 = 80$

Fictional books =  $210 - 80 = 130$

**For B,**

Let fiction books and non-fiction books be y and x.

$x + y = 760$

$y - x = 378$

so,  $y = 569$ ,  $x = 191$

**For C**

Total books = 360, Non-fiction books = 120, Fiction books = 240

**For D**

Total books = 495

Total non-fiction books =  $\frac{5}{9}$  of 495 = 275

Total fiction books = 220

**For E**

Total books = 560

Total non - fiction books = 14.28% of 560 = 80

Total fiction books = 480

Shopkeepers	Total books	Non-fiction books	Fiction books
A	210	80	130
B	760	191	569
C	360	120	240
D	495	275	220
E	560	80	480



Required answer =  $20\%$  of  $120 \times 25 + 80\%$  of  $120 \times 20 = 600 + 1920 = 2520$  Rs

**S42. Ans.(b)**

**Sol.**

**For A,**

Total books = 210

Non - fiction books =  $\frac{8}{13+8} \times 210 = 80$

Fictional books =  $210 - 80 = 130$

**For B,**

Let fiction books and non-fiction books be y and x.

$x + y = 760$

$y - x = 378$

so,  $y = 569$ ,  $x = 191$

**For C**

Total books = 360, Non-fiction books = 120, Fiction books = 240

**For D**

Total books = 495

Total non-fiction books =  $\frac{5}{9}$  of 495 = 275

Total fiction books = 220

**For E**

Total books = 560

Total non - fiction books = 14.28% of 560 = 80

Total fiction books = 480

Shopkeepers	Total books	Non-fiction books	Fiction books
<b>A</b>	210	80	130
<b>B</b>	760	191	569
<b>C</b>	360	120	240
<b>D</b>	495	275	220
<b>E</b>	560	80	480

Required ratio =  $120+130 : 360+560 = 250 : 920 = 25:92$

**S43. Ans.(b)**

**Sol.**

**For A,**

Total books = 210

Non - fiction books =  $\frac{8}{13+8} \times 210 = 80$

Fictional books =  $210 - 80 = 130$

**For B,**

Let fiction books and non-fiction books be y and x.

$x + y = 760$

$y - x = 378$

so,  $y = 569, x = 191$

**For C**

Total books = 360, Non-fiction books = 120, Fiction books = 240

**For D**

Total books = 495

Total non-fiction books =  $\frac{5}{9}$  of 495 = 275

Total fiction books = 220

**For E**

Total books = 560

Total non - fiction books = 14.28% of 560 = 80

Total fiction books = 480

Shopkeepers	Total books	Non-fiction books	Fiction books
A	210	80	130
B	760	191	569
C	360	120	240
D	495	275	220
E	560	80	480

$$\text{Required answer} = \frac{\frac{130+480}{2}}{130+220} \times 100 = \frac{305}{350} \times 100 = 87.14\% = 87\% \text{ (approx.)}$$

S44. Ans.(c)

Sol.

For A,

Total books = 210

Non - fiction books =  $\frac{8}{13+8} \times 210 = 80$

Fictional books =  $210 - 80 = 130$

For B,

Let fiction books and non-fiction books be y and x.

$x + y = 760$

$y - x = 378$

so,  $y = 569, x = 191$

For C

Total books = 360, Non-fiction books = 120, Fiction books = 240

For D

Total books = 495

Total non-fiction books =  $\frac{5}{9}$  of 495 = 275

Total fiction books = 220

For E

Total books = 560

Total non - fiction books = 14.28% of 560 = 80

Total fiction books = 480



Shopkeepers	Total books	Non-fiction books	Fiction books
A	210	80	130
B	760	191	569
C	360	120	240
D	495	275	220
E	560	80	480

Defective books =  $\frac{1}{7}$  of 560 = 80

Defective non - fiction books = 20% of 80 = 16

Defective fiction books =  $80 - 16 = 64$

Required answer =  $360 - 64 = 296$

S45. Ans.(d)

Sol.

For A,

Total books = 210

$$\text{Non - fiction books} = \frac{8}{13+8} \times 210 = 80$$

$$\text{Fictional books} = 210 - 80 = 130$$

For B,

Let fiction books and non-fiction books be y and x.

$$x + y = 760$$

$$y - x = 378$$

$$\text{so, } y = 569, x = 191$$

For C

Total books = 360, Non-fiction books = 120, Fiction books = 240

For D

Total books = 495

Total non-fiction books =  $\frac{5}{9}$  of 495 = 275

Total fiction books = 220

For E

Total books = 560

Total non - fiction books = 14.28% of 560 = 80

Total fiction books = 480

Shopkeepers	Total books	Non-fiction books	Fiction books
A	210	80	130
B	760	191	569
C	360	120	240
D	495	275	220
E	560	80	480



$$\text{Total books sold by Z} = \frac{23}{13} \times 130 = 230$$

$$\text{Fictional books sold by Z} = 30\% \text{ of } 230 = 69$$

$$\text{Non - fictional books sold by Z} = 230 - 69 = 161$$

S46. Ans.(b)

Sol.

Showrooms	Total vehicles	Total bikes	Total cars
A	150	80	70
B	190	100	90
C	150	110	40
D	200	160	40
E	130	70	60



Bikes in F = 125% of 60 = 75

Total vehicle =  $\frac{150+190}{2} = 170$

Cars in F = 170 - 75 = 95

Required answer =  $\frac{95-100}{100} \times 100 = 5\%$

S47. Ans.(a)

Sol.

Showrooms	Total vehicles	Total bikes	Total cars
A	150	80	70
B	190	100	90
C	150	110	40
D	200	160	40
E	130	70	60

Required answer =  $\frac{110+70}{2} - \frac{70+90}{2} = 90 - 80 = 10$

S48. Ans.(b)

Sol.

Showrooms	Total vehicles	Total bikes	Total cars
A	150	80	70
B	190	100	90
C	150	110	40
D	200	160	40
E	130	70	60

Sold bike =  $\frac{3}{4}$  of 160 = 120

Unsold bikes = 160 - 120 = 40

Car sold in B =  $\frac{100}{80} \times 40 = 50$

Unsold car in B = 90 - 50 = 40

S49. Ans.(b)

Sol.

Showrooms	Total vehicles	Total bikes	Total cars
A	150	80	70
B	190	100	90
C	150	110	40
D	200	160	40
E	130	70	60

Online booked cars = 60

Car booked offline =  $70 - 60 = 10$

Bike booked online = 20% of 80 = 16

Bike booked offline =  $80 - 16 = 64$

Required answer =  $(60 + 16) - (10 + 64) = 76 - 74 = 2$

**S50. Ans.(a)**

**Sol.**

Showrooms	Total vehicles	Total bikes	Total cars
A	150	80	70
B	190	100	90
C	150	110	40
D	200	160	40
E	130	70	60

Defective cars in D =  $1/8$  of 80 = 10

Non defective cars in D =  $40 - 10 = 30$

Non - defective bike in D =  $1/2$  of 30 = 15

Defective bike in D =  $160 - 15 = 145$

Required answer =  $145 + 10 = 155$

**S51. Ans.(b)**

**Sol.**

Shops	Wired chargers	Wireless chargers	Total
A	10x	9x	
B		12.5x+10	125
C		12.5x	167
<b>Total</b>		146	

$$9x + 12.5x + 12.5x + 10 = 146$$

$$4 = x$$

Shops	Wired chargers	Wireless chargers	Total
A	40	36	76
B	65	60	125
C	107	50	167

Required ratio =  $60:40 = 3:2$

S52. Ans.(b)

Sol.

Shops	Wired chargers	Wireless chargers	Total
A	10x	9x	
B		12.5x+10	125
C		12.5x	167
<b>Total</b>		146	

$$9x+12.5x+12.5x+10 = 146$$

$$4 = x$$

Shops	Wired chargers	Wireless chargers	Total
A	40	36	76
B	65	60	125
C	107	50	167

$$\text{Required answer} = 125 - 76 = 49$$

S53. Ans.(b)

Sol.

Shops	Wired chargers	Wireless chargers	Total
A	10x	9x	
B		12.5x+10	125
C		12.5x	167
<b>Total</b>		146	

$$9x+12.5x+12.5x+10 = 146$$

$$4 = x$$

Shops	Wired chargers	Wireless chargers	Total
A	40	36	76
B	65	60	125
C	107	50	167

$$\text{Required answer} = 125+40 = 165$$

S54. Ans.(c)

Sol.

Shops	Wired chargers	Wireless chargers	Total
A	10x	9x	
B		12.5x+10	125
C		12.5x	167
<b>Total</b>		146	

$$9x+12.5x+12.5x+10 = 146$$

$$4 = x$$

Shops	Wired chargers	Wireless chargers	Total
A	40	36	76
B	65	60	125
C	107	50	167

Chargers sold by D = 120% of 125 = 150

Wired chargers sold by D = 2/3 of 150 = 100

Required answer = 100 - 36 = 64

S55. Ans.(a)

Sol.

Shops	Wired chargers	Wireless chargers	Total
A	10x	9x	
B		12.5x+10	125
C		12.5x	167
<b>Total</b>		146	

$$9x+12.5x+12.5x+10 = 146$$

$$4 = x$$

Shops	Wired chargers	Wireless chargers	Total
A	40	36	76
B	65	60	125
C	107	50	167

Profit = 10% of 20 = Rs 2

Required answer = 2 × (40 + 65) = Rs. 210

**S56. Ans.(c)**

**Sol.**

Let set A number be  $7y, 7(y+1)$  and  $7(y+2)$

Let set B number be  $x, x+2, x+4, x+6$  &  $x+8$

ATQ,

$$7(y+2) = x$$

$$x - 7y = 14 \dots (i)$$

And

$$(7y+x)/2 = 28$$

$$x + 7y = 56 \dots (ii)$$

$$x = 35$$

$$\text{and } y = 3$$

$$\text{Required difference} = 41 - 28 = 13$$

**S57. Ans.(b)**

**Sol.**

$$\text{LCM} = 160$$

$$16 = 2 \times 8$$

$$40 = 5 \times 8$$

So, for 160 LCM, X can be 32 or 160

$$32 = 2 \times 2 \times 8$$

$$160 = 2 \times 2 \times 5 \times 8$$

**From I.** 32 & 160 both are multiple of 2, so we can't determine exact value of X

**From II.** 160 is divisible by 5, so only II possible to find exact value of X

**S58. Ans.(d)**

**Sol.**

Let the length of the train A be  $l$  meters

From II.

Given,

$$\frac{l}{10} = \text{Speed of train A}$$

$$\frac{l+150}{17.5} = \text{Speed of train A}$$

$$\frac{l+150}{17.5} = \frac{l}{10}$$

$$10l + 1500 = 17.5l$$

$$1500 = 7.5l$$

$$200 = l$$

From I.

The length of train A is the same as the length of train B.

So, the length of train B = 200 meters

**S59. Ans.(c)**

**Sol.**

Let the monthly income of A be Rs  $100x$

$$\text{Amount spend on groceries} = 100x \times \frac{25}{100} = Rs\ 25x$$

$$\text{Amount spend on Rent} = (100x - 25x) \times \frac{20}{100} = 15x$$

$$\text{Amount spend on cloth} = (100x - 25x - 15x) \times \frac{3}{10} = Rs\ 18x$$

ATQ,

$$18x - 15x = 570$$

$$x = 190$$

$$\text{Required income} = 100x = 19000\ Rs$$

**S60. Ans.(c)**

**Sol.**

Let the cost price be Rs  $100x$

$$\text{Marked price} = 100x \times \frac{150}{100} = Rs\ 150x$$

$$\text{Selling price} = 150x \times \frac{80}{100} = Rs\ 120x$$

ATQ,

$$120x - 100x = 40$$

$$x = 2$$

$$\text{The cost price} = 200\ Rs$$

$$\text{Marked price} = 300\ Rs$$

$$\text{Selling price} = 300 \times \frac{75}{100} = Rs\ 225$$

$$\text{Required profit} = 225 - 200 = 25\ Rs$$



**S61. Ans.(a)**

**Sol.**

Let the present age of A and B be  $5x+7$  and  $3x+7$  years respectively.

ATQ,

$$\frac{5x + 7 + 4}{3x + 7 + 3} = \frac{36}{25}$$

$$125x + 275 = 108x + 360$$

$$17x = 85$$

$$x = 5$$

$$\text{Required age} = 3x+7 = 22\ \text{years}$$

**S62. Ans.(e)**

**Sol.**

ATQ,

$$\frac{12 \times 15 + X \times 10}{12 + X} = 12.4$$

$$180 + 10X = 148.8 + 12.4X$$

$$31.2 = 2.4X$$

$$X = 13$$

**S63. Ans.(d)**

**Sol.** Let the initial investment of Rachit and Varun be Rs X and Rs (18000 - X)

The profit-sharing ratio of Rachit and Varun =  $X \times 6 + (X - 2000) \times 6 : (18000 - X) \times 12$   
 $= 2X - 2000 : 36000 - 2X$

ATQ,

$$\frac{2X - 2000}{36000 - 2X} = \frac{2200}{1200}$$

$$\frac{X - 1000}{18000 - X} = \frac{11}{6}$$

$$6X - 6000 = 198000 - 11X$$

$$204000 = 17X$$

$$12000 = X$$

**S64. Ans.(c)**

**Sol.**

Let the efficiency of a man and a woman be m and w units/day respectively.

$$\text{Given, } X \times 15 \times m = \frac{3X}{4} \times 12 \times w$$

$$\frac{m}{w} = \frac{3}{5} = \frac{3a}{5a}$$

$$\text{Total work} = (5 \times 3a + 6 \times 5a)12 = 540a$$

$$\text{Required days} = \frac{540a}{8 \times 3a} = 22.5 \text{ days}$$

**S65. Ans.(c)**

**Sol.** Let the quantity of milk and water in the vessel be 5a and 3a respectively

ATQ,

$$\frac{5a - 32 \times \frac{5}{8}}{3a - 32 \times \frac{3}{8} + 4} = \frac{3}{2}$$

$$\frac{5a - 20}{3a - 8} = \frac{3}{2}$$

$$10a - 40 = 9a - 24$$

$$a = 16$$

$$a = 16$$

$$\text{Required quantity} = 16 \times 8 = 128 \text{ liters}$$

S66. Ans.(a)

Sol.

$$\text{Cumulative compound interest} = \left(20 + 20 + \frac{20 \times 20}{100}\right)\% = 44\%$$

ATQ,

$$\left(X \times \frac{21}{100} \times 3\right) - X \times \frac{44}{100} = 1900$$

$$\frac{63X}{100} - \frac{44X}{100} = 1900$$

$$X = 10000$$

S67. Ans.(d)

Sol.

$$\text{Perimeter of A} = 2(16 + 24) = 80 \text{ cm}$$

$$\text{Perimeter of B} = 80 \times \frac{30}{100} = 24 \text{ cm}$$

$$\text{Length of the B} = \frac{1}{3} \times 24 = 8 \text{ cm}$$

Breadth of the B be  $b$  cm

ATQ,

$$2(8 + b) = 24$$

$$b = 4$$

$$\text{Required area} = 4 \times 8 = 32 \text{ sq. cm}$$

S68. Ans.(d)

Sol.

$$\text{I. } x^2 - 18x + 65 = 0$$

$$x^2 - 13x - 5x + 65 = 0$$

$$x = 13, 5$$

$$\text{II. } y^2 - 29y + 208 = 0$$

$$y^2 - 16y - 13y + 208 = 0$$

$$y = 16, 13$$

$$\text{So, } x \leq y$$

S69. Ans.(e)

Sol.

$$\text{I. } x^2 - 15x + 50 = 0$$

$$x^2 - 5x - 10x + 50 = 0$$

$$x = 5, 10$$

$$\text{II. } y^2 - 12y + 35 = 0$$

$$y^2 - 7y - 5y + 35 = 0$$

$$y = 5, 7$$

So, no relation can be established between  $x$  and  $y$



**S70. Ans.(b)**

**Sol.**

I.  $x^2 - 14x + 49 = 0$

$x^2 - 7x - 7x + 49 = 0$

$x = 7, 7$

II.  $y^2 - 10y + 21 = 0$

$y^2 - 7y - 3y + 21 = 0$

$y = 7, 3$

So,  $x \geq y$

**S71. Ans.(e)**

**Sol.** Final Arrangement:

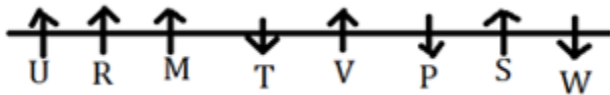

**Clues:** T sits fourth to the right of W. Four persons sit between M and W. R sits second to the right of T. More than two persons sit between W and R. Both the immediate neighbours of M face opposite direction to each other. U sits immediate left of R.

**Inference:** Here we get two possible cases:

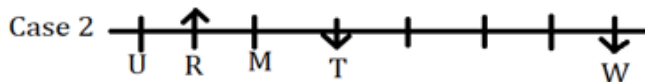
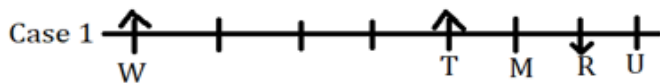

**Clues:** S sits fourth to the right of M. Immediate neighbours of S face the same direction. V and P sits immediate right of each other. P doesn't face in the north direction. The persons who sit at the extreme ends face the opposite direction to each other.

**Inference:** The number of persons facing north is more than the number of persons facing south. Case 1 gets cancelled here:

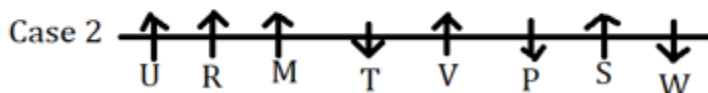
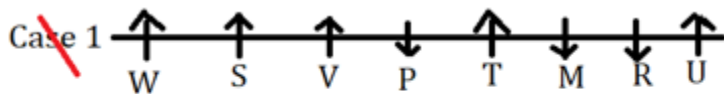

**Inference:** Now, the final Arrangement is:

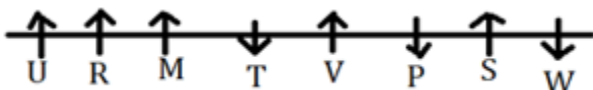

R sits fourth to the right of P.

S72. Ans.(d)

Sol. Final Arrangement:

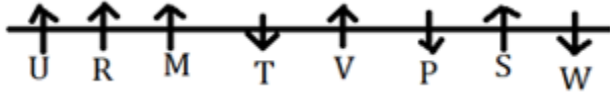

**Clues:** T sits fourth to the right of W. Four persons sit between M and W. R sits second to the right of T. More than two persons sit between W and R. Both the immediate neighbours of M face opposite direction to each other. U sits immediate left of R.

**Inference:** Here we get two possible cases:

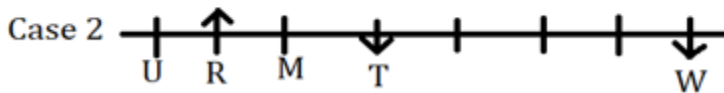
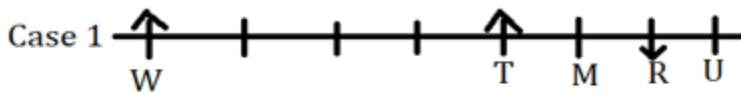

**Clues:** S sits fourth to the right of M. Immediate neighbours of S face the same direction. V and P sits immediate right of each other. P doesn't face in the north direction. The persons who sit at the extreme ends face the opposite direction to each other.

**Inference:** The number of persons facing north is more than the number of persons facing south. Case 1 gets cancelled here:

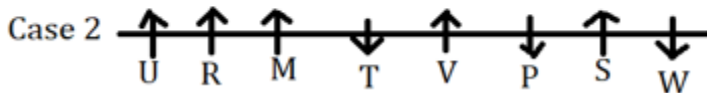
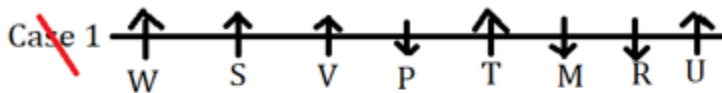

**Inference:** Now, the final Arrangement is:

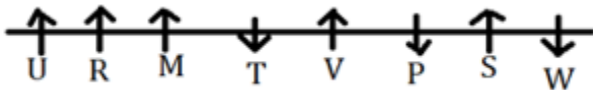

"T sits fourth to the right of U" is the false statement.

S73. Ans.(d)

Sol. Final Arrangement:

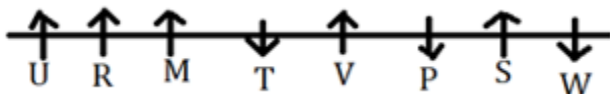

**Clues:** T sits fourth to the right of W. Four persons sit between M and W. R sits second to the right of T. More than two persons sit between W and R. Both the immediate neighbours of M face opposite direction to each other. U sits immediate left of R.

**Inference:** Here we get two possible cases:

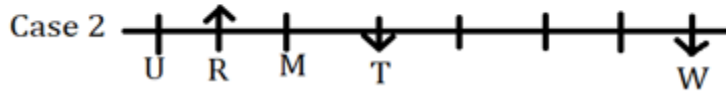
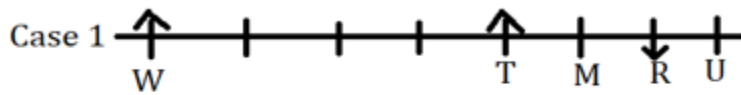

**Clues:** S sits fourth to the right of M. Immediate neighbours of S face the same direction. V and P sits immediate right of each other. P doesn't face in the north direction. The persons who sit at the extreme ends face the opposite direction to each other.

**Inference:** The number of persons facing north is more than the number of persons facing south. Case 1 gets cancelled here:

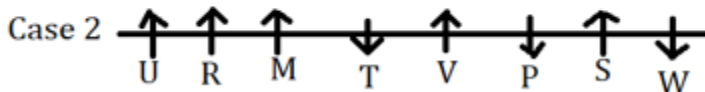
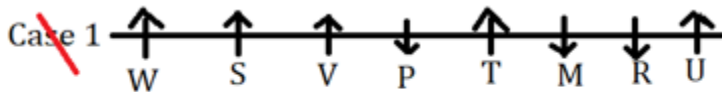

**Inference:** Now, the final Arrangement is:

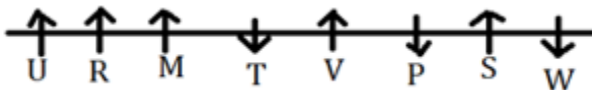

T will sit third to the right of P, after interchanging the positions.

**S74. Ans.(e)**

**Sol.** Final Arrangement:

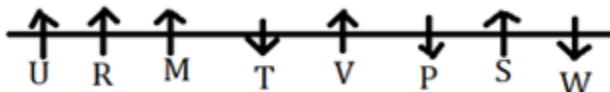

**Clues:** T sits fourth to the right of W. Four persons sit between M and W. R sits second to the right of T. More than two persons sit between W and R. Both the immediate neighbours of M face opposite direction to each other. U sits immediate left of R.

**Inference:** Here we get two possible cases:

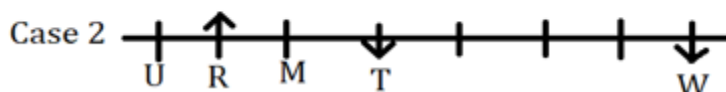
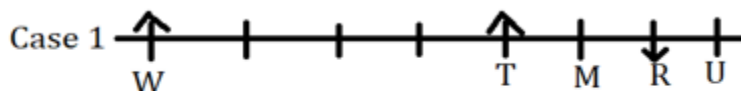

**Clues:** S sits fourth to the right of M. Immediate neighbours of S face the same direction. V and P sits immediate right of each other. P doesn't face in the north direction. The persons who sit at the extreme ends face the opposite direction to each other.

**Inference:** The number of persons facing north is more than the number of persons facing south. Case 1 gets cancelled here:

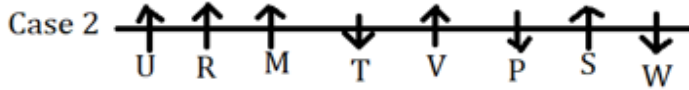
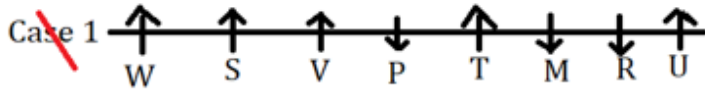

**Inference:** Now, the final Arrangement is:

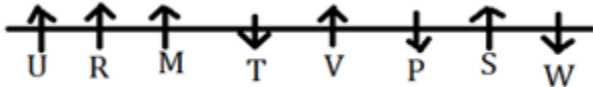

R and S face the same direction.

**S75. Ans.(c)**

**Sol.** Final Arrangement:

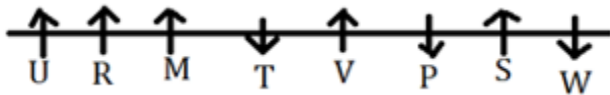

**Clues:** T sits fourth to the right of W. Four persons sit between M and W. R sits second to the right of T. More than two persons sit between W and R. Both the immediate neighbours of M face opposite direction to each other. U sits immediate left of R.

**Inference:** Here we get two possible cases:

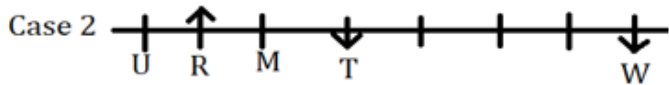
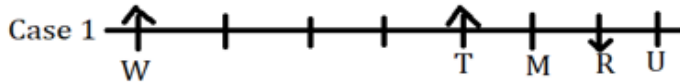

**Clues:** S sits fourth to the right of M. Immediate neighbours of S face the same direction. V and P sits immediate right of each other. P doesn't face in the north direction. The persons who sit at the extreme ends face the opposite direction to each other.

**Inference:** The number of persons facing north is more than the number of persons facing south. Case 1 gets cancelled here:

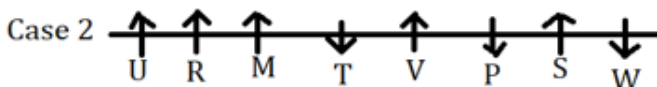
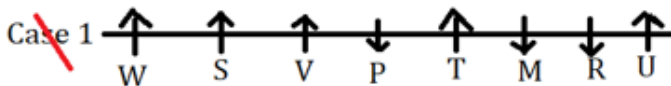

**Inference:** Now, the final Arrangement is:

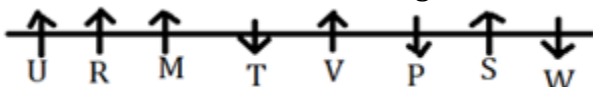

Fifth to the right.

**S76. Ans.(d)**

**Sol.** Final Arrangement:

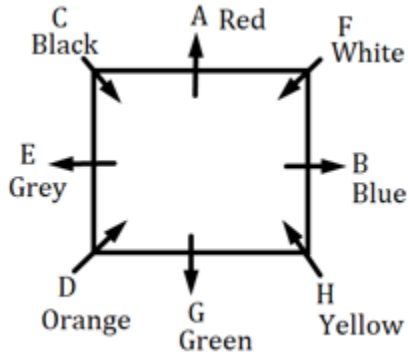

**Clues:** The one who sits fifth to the right of G likes white colour. One person sits between the ones who like white colour and black colour. D sits immediately to the right of G. The one who likes black colour is not an immediate neighbour of G but sits third to the left of B.

**Inference:** Here we get two possible cases:

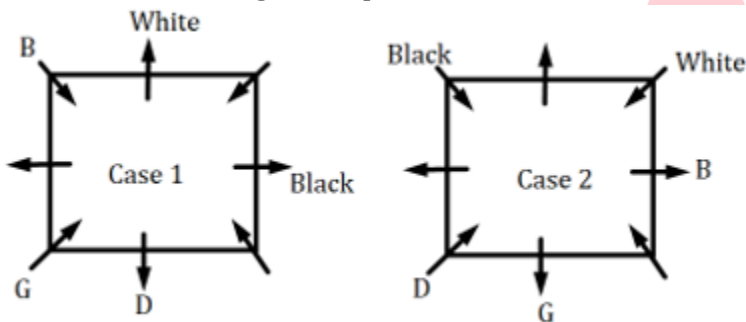

**Clues:** B sits opposite to E who likes Grey colour. A sits second to the right of E. H sits second to the right of the one who likes Orange colour. H doesn't like white colour.

**Inference:** Above clues are placed in both cases:

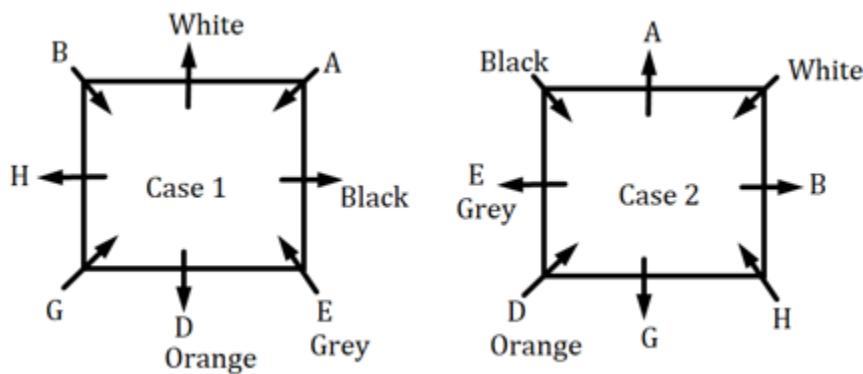

**Clues:** The one who sits immediate right of H likes Blue colour. C sits second to the right of F but doesn't sit opposite to the one who likes Red colour and Green colour. G doesn't like Red Colour. The one who likes Green colour doesn't sit at the corners.

**Inference:** Case 1 gets cancelled here. H will like yellow color and F will like white color.

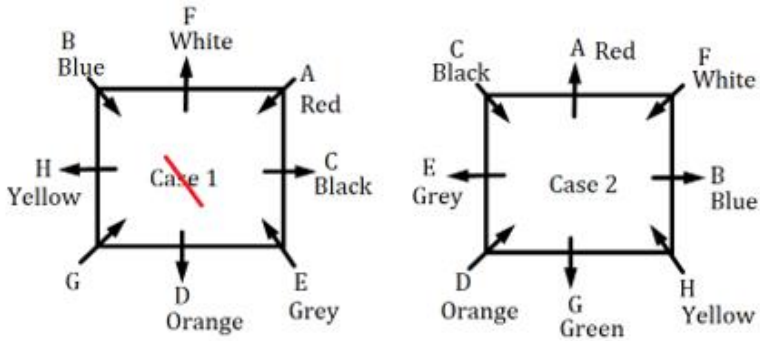

**Inference:** Now, the final Arrangement is:

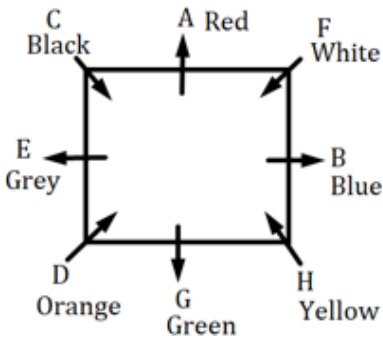

The one who likes Black colour.

**S77. Ans.(e)**

**Sol.** Final Arrangement:

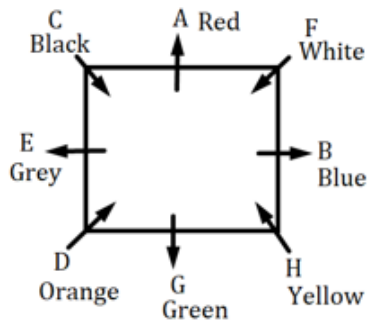

**Clues:** The one who sits fifth to the right of G likes white colour. One person sits between the ones who like white colour and black colour. D sits immediately to the right of G. The one who likes black colour is not an immediate neighbour of G but sits third to the left of B.

**Inference:** Here we get two possible cases:

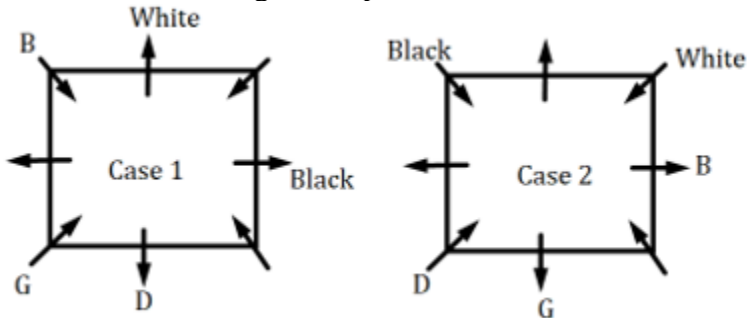

**Clues:** B sits opposite to E who likes Grey colour. A sits second to the right of E. H sits second to the right of the one who likes Orange colour. H doesn't like white colour.

**Inference:** Above clues are placed in both cases:

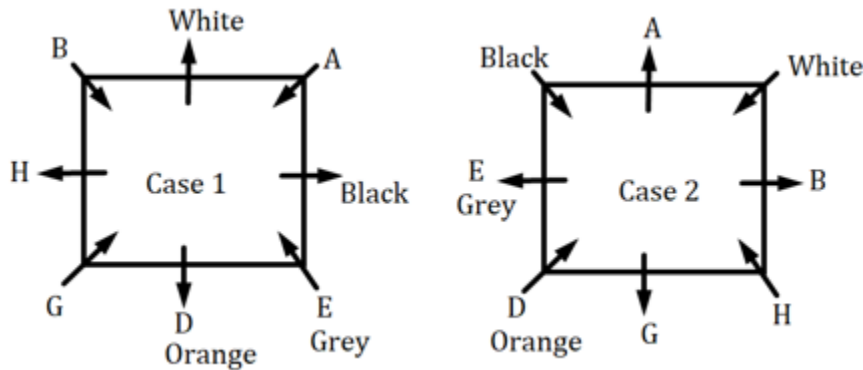

**Clues:** The one who sits immediate right of H likes Blue colour. C sits second to the right of F but doesn't sit opposite to the one who likes Red colour and Green colour. G doesn't like Red Colour. The one who likes Green colour doesn't sit at the corners.

**Inference:** Case 1 gets cancelled here. H will like yellow color and F will like white color.

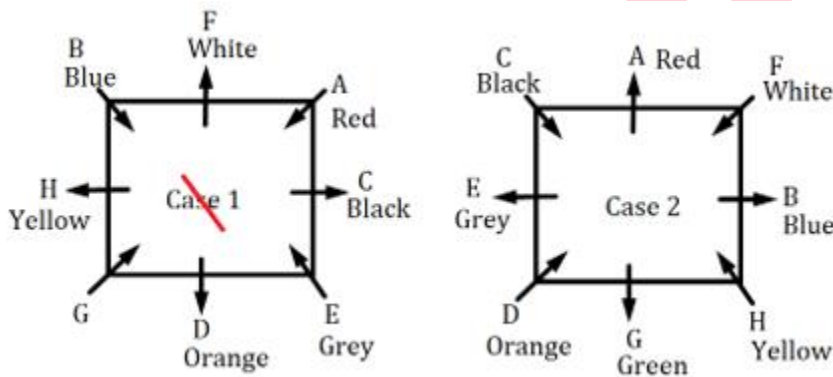

**Inference:** Now, the final Arrangement is:

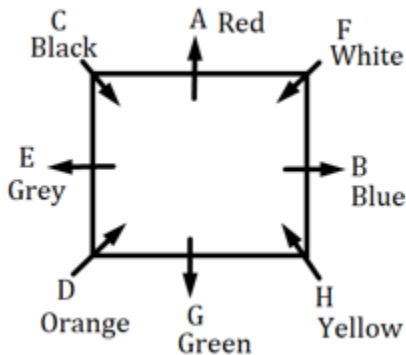





Second to the right



Test

Prime

ALL EXAMS,  
ONE SUBSCRIPTION.

**S78. Ans.(a)**

**Sol.** Final Arrangement:

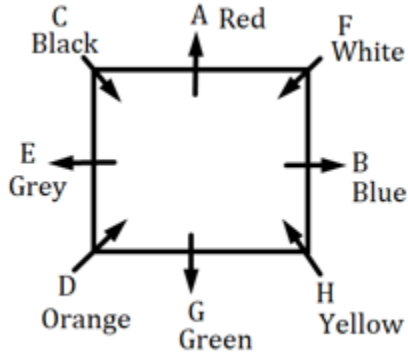

**Clues:** The one who sits fifth to the right of G likes white colour. One person sits between the ones who like white colour and black colour. D sits immediately to the right of G. The one who likes black colour is not an immediate neighbour of G but sits third to the left of B.

**Inference:** Here we get two possible cases:

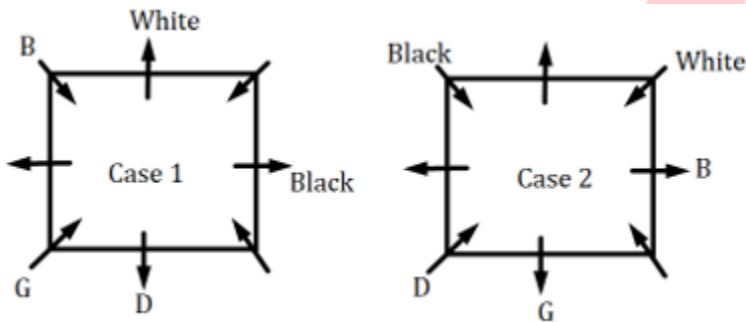

**Clues:** B sits opposite to E who likes Grey colour. A sits second to the right of E. H sits second to the right of the one who likes Orange colour. H doesn't like white colour.

**Inference:** Above clues are placed in both cases:

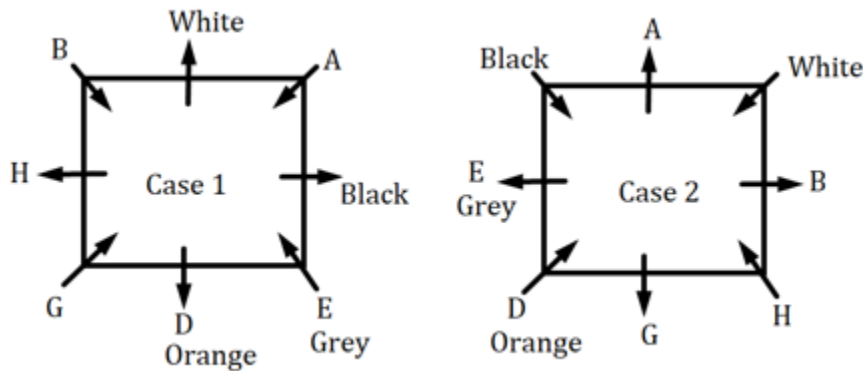

**Clues:** The one who sits immediate right of H likes Blue colour. C sits second to the right of F but doesn't sit opposite to the one who likes Red colour and Green colour. G doesn't like Red Colour. The one who likes Green colour doesn't sit at the corners.



**Inference:** Case 1 gets cancelled here. H will like yellow color and F will like white color.

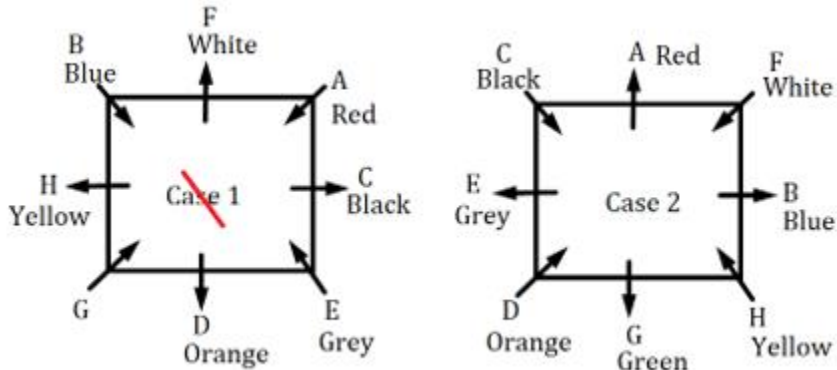

**Inference:** Now, the final Arrangement is:

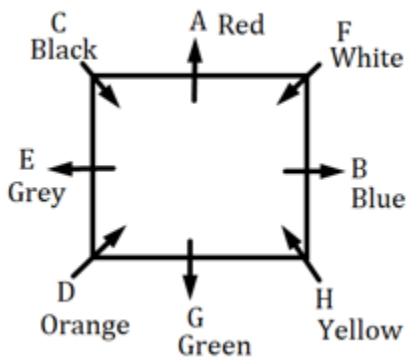

Four persons sit between D and B when counted from the left of D.

**S79. Ans.(b)**

**Sol.**

Final Arrangement:

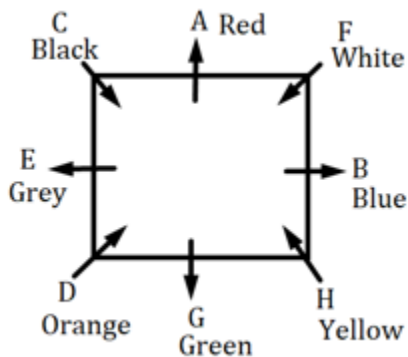

**Clues:** The one who sits fifth to the right of G likes white colour. One person sits between the ones who like white colour and black colour. D sits immediately to the right of G. The one who likes black colour is not an immediate neighbour of G but sits third to the left of B.

**Inference:** Here we get two possible cases:

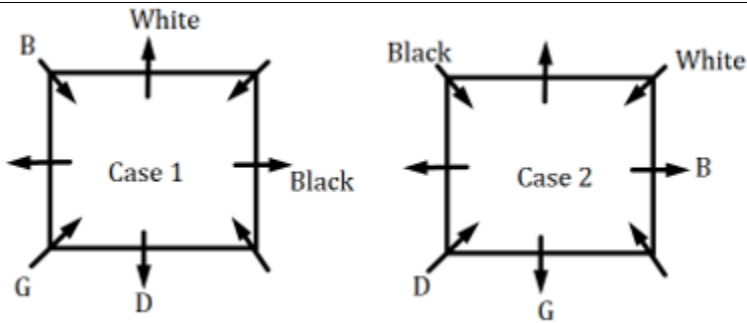

**Clues:** B sits opposite to E who likes Grey colour. A sits second to the right of E. H sits second to the right of the one who likes Orange colour. H doesn't like white colour.

**Inference:** Above clues are placed in both cases:

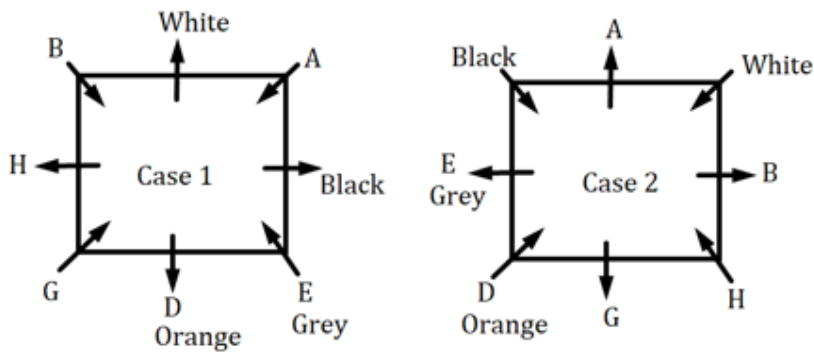

**Clues:** The one who sits immediate right of H likes Blue colour. C sits second to the right of F but doesn't sit opposite to the one who likes Red colour and Green colour. G doesn't like Red Colour. The one who likes Green colour doesn't sit at the corners.

**Inference:** Case 1 gets cancelled here. H will like yellow color and F will like white color.

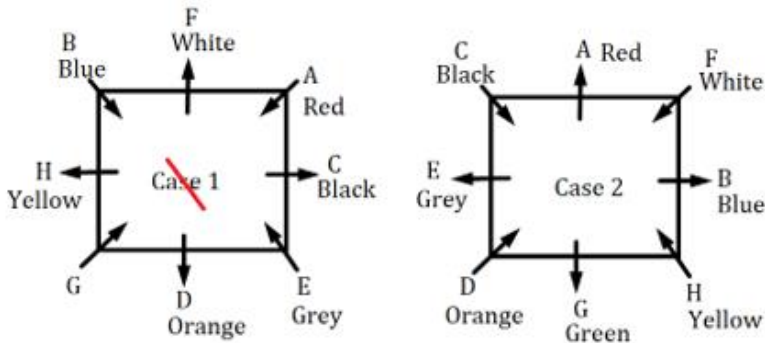

**Inference:** Now, the final Arrangement is:

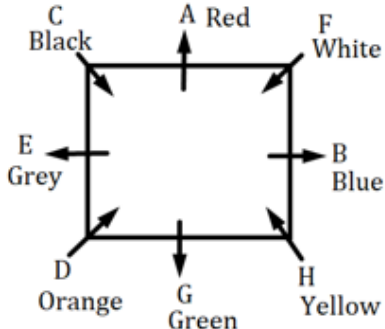

Except A, all the other persons sit at corners.



**S80. Ans.(d)**

**Sol.** Final Arrangement:

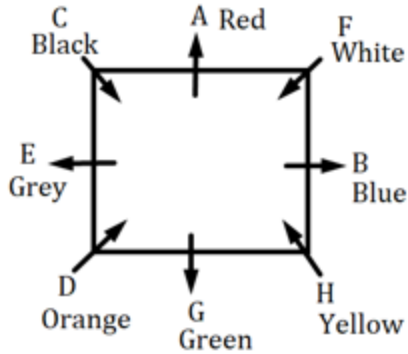

**Clues:** The one who sits fifth to the right of G likes white colour. One person sits between the ones who like white colour and black colour. D sits immediately to the right of G. The one who likes black colour is not an immediate neighbour of G but sits third to the left of B.

**Inference:** Here we get two possible cases:

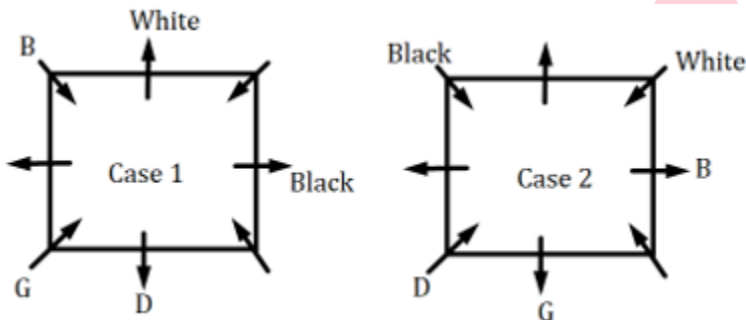

**Clues:** B sits opposite to A who likes Grey colour. A sits second to the right of E. H sits second to the right of the one who likes Orange colour. H doesn't like white colour.

**Inference:** Above clues are placed in both cases:

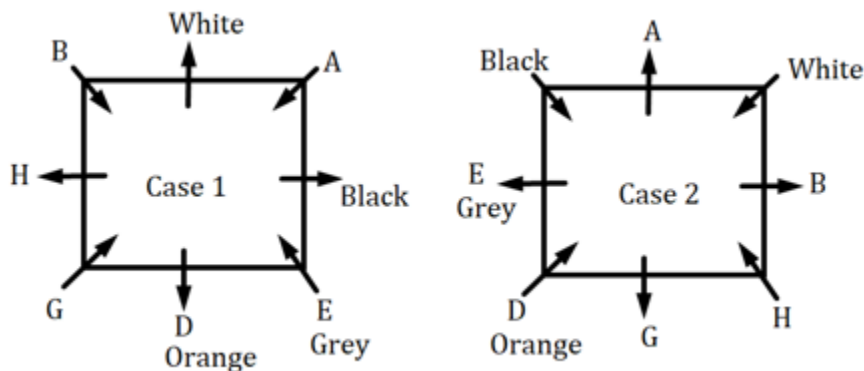

**Clues:** The one who sits immediate right of H likes Blue colour. C sits second to the right of F but doesn't sit opposite to the one who likes Red colour and Green colour. G doesn't like Red Colour. The one who likes Green colour doesn't sit at the corners.

**Inference:** Case 1 gets cancelled here. H will like yellow color and F will like white color.

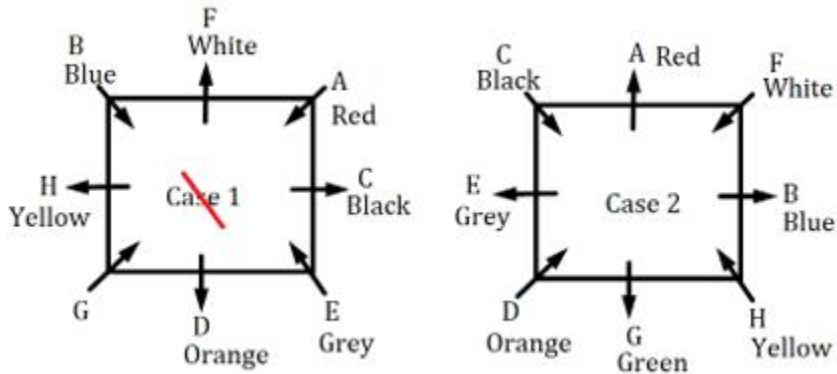

**Inference:** Now, the final Arrangement is:

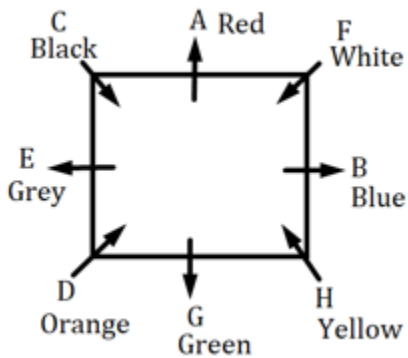

Both II and III are true

**S81. Ans.(d)**

**Sol.** Three pairs are formed.



**S82. Ans.(b)**

**Sol.** Final Arrangement:

Designations	Persons
CEO	E
Manager	I
HR	D
Supervisor	A
Team Lead	C
Executive	F
Accountant	G
Clerk	B
Peon	H

**Clues:** D is four designations senior to G. G is designated immediately senior to B who is not peon. Two persons are designated between A and E. E is senior to A.

**Inference:** We have three possible cases here:

Designations	Persons	Persons	Persons
	Case 1	Case 2	Case 3
CEO	D	E/	E/
Manager		D	E/
HR			D
Supervisor	E	A/	A/
Team Lead	G	E/	A/
Executive	B	G	E/
Accountant	A	B	G
Clerk		A/	B
Peon			A/

**Clues:** F is designated junior to A but not immediately junior. F is not designated as the junior most person.

**Inference:** Case 1 gets cancelled here:

Designations	Persons	Persons	Persons
	Case 1	Case 2	Case 3
CEO	<del>D</del>	E	E
Manager		D	
HR			D
Supervisor	<del>E</del>	A	A
Team Lead	<del>G</del>		
Executive	<del>B</del>	G	F
Accountant	<del>A</del>	B	G
Clerk		F	B
Peon			

**Clues:** I is designated senior to C and H. I is not designated as HR. H is designated junior to C

**Inference:** Case 2 gets cancelled here:

Designations	Persons	Persons
	Case 2	Case 3
CEO	<del>E</del>	E
Manager	<del>D</del>	I
HR	<del>I</del>	D
Supervisor	<del>A</del>	A
Team Lead	<del>G</del>	C
Executive	<del>G</del>	F
Accountant	<del>B</del>	G
Clerk	<del>F</del>	B
Peon	<del>H</del>	H

**Inference:** Now, the final Arrangement is here:

Designations	Persons
CEO	E
Manager	I
HR	D
Supervisor	A
Team Lead	C
Executive	F
Accountant	G
Clerk	B
Peon	H

The person who is two persons senior to B i.e. F is designated as Executive.

**S83. Ans.(c)**

**Sol.**

Final Arrangement:

Designations	Persons
CEO	E
Manager	I
HR	D
Supervisor	A
Team Lead	C
Executive	F
Accountant	G
Clerk	B
Peon	H

**Clues:** D is four designations senior to G. G is designated immediately senior to B who is not peon. Two persons are designated between A and E. E is senior to A.

**Inference:** We have three possible cases here:

Designations	Persons		
	Case 1	Case 2	Case 3
CEO	D	E/	E/
Manager		D	E/
HR			D
Supervisor	E	A/	A/
Team Lead	G	E/	A/
Executive	B	G	E/
Accountant	A	B	G
Clerk		A/	B
Peon			A/

**Clues:** F is designated junior to A but not immediately junior. F is not designated as the junior most person.

**Inference:** Case 1 gets cancelled here:

Designations	Persons	Persons	Persons
	Case 1	Case 2	Case 3
CEO	D	E	E
Manager		D	
HR			D
Supervisor	E	A	A
Team Lead	G		
Executive	B	G	F
Accountant	A	B	G
Clerk		F	B
Peon			

**Clues:** I is designated senior to C and H. I is not designated as HR. H is designated junior to C

**Inference:** Case 2 gets cancelled here:

Designations	Persons	Persons
	Case 2	Case 3
CEO	E	E
Manager	D	I
HR	I	D
Supervisor	A	A
Team Lead	G	C
Executive	G	F
Accountant	B	G
Clerk	F	B
Peon	H	H

**Inference:** Now, the final Arrangement is here:

Designations	Persons
CEO	E
Manager	I
HR	D
Supervisor	A
Team Lead	C
Executive	F
Accountant	G
Clerk	B
Peon	H

Four persons are designated between I and the one who is immediately junior to F

**S84. Ans.(a)**

**Sol.**Final Arrangement:

Designations	Persons
CEO	E
Manager	I
HR	D
Supervisor	A
Team Lead	C
Executive	F
Accountant	G
Clerk	B
Peon	H

**Clues:** D is four designations senior to G. G is designated immediately senior to B who is not peon. Two persons are designated between A and E. E is senior to A.

**Inference:** We have three possible cases here:

Designations	Persons	Persons	Persons
	Case 1	Case 2	Case 3
CEO	D	E/	E/
Manager		D	E/
HR			D
Supervisor	E	A/	A/
Team Lead	G	E/	A/
Executive	B	G	E/
Accountant	A	B	G
Clerk		A/	B
Peon			A/

**Clues:** F is designated junior to A but not immediately junior. F is not designated as the junior most person.

**Inference:** Case 1 gets cancelled here:

Designations	Persons	Persons	Persons
	Case 1	Case 2	Case 3
CEO	<del>D</del>	E	E
Manager		D	
HR			D
Supervisor	<del>E</del>	A	A
Team Lead	<del>G</del>		
Executive	<del>B</del>	G	F
Accountant	<del>A</del>	B	G
Clerk		F	B
Peon			

**Clues:** I is designated senior to C and H. I is not designated as HR. H is designated junior to C

**Inference:** Case 2 gets cancelled here:

Designations	Persons	Persons
	Case 2	Case 3
CEO	<del>E</del>	E
Manager	<del>D</del>	I
HR	<del>I</del>	D
Supervisor	<del>A</del>	A
Team Lead	<del>G</del>	C
Executive	<del>G</del>	F
Accountant	<del>B</del>	G
Clerk	<del>F</del>	B
Peon	<del>H</del>	H

**Inference:** Now, the final Arrangement is here:



Designations	Persons
CEO	E
Manager	I
HR	D
Supervisor	A
Team Lead	C
Executive	F
Accountant	G
Clerk	B
Peon	H

Two persons remain unchanged.

Designations	Persons	Persons (After Alphabetical Order)
CEO	E	A
Manager	I	B
HR	D	C
Supervisor	A	D
Team Lead	C	E
Executive	F	F
Accountant	G	G
Clerk	B	H
Peon	H	I

S85. Ans.(e)

Sol. Final Arrangement:

Designations	Persons
CEO	E
Manager	I
HR	D
Supervisor	A
Team Lead	C
Executive	F
Accountant	G
Clerk	B
Peon	H

**Clues:** D is four designations senior to G. G is designated immediately senior to B who is not peon. Two persons are designated between A and E. E is senior to A.

**Inference:** We have three possible cases here:

Designations	Persons	Persons	Persons
	Case 1	Case 2	Case 3
CEO	D	E/	E/
Manager		D	E/
HR			D
Supervisor	E	A/	A/
Team Lead	G	E/	A/
Executive	B	G	E/
Accountant	A	B	G
Clerk		A/	B
Peon			A/

**Clues:** F is designated junior to A but not immediately junior. F is not designated as the junior most person.

**Inference:** Case 1 gets cancelled here:

Designations	Persons	Persons	Persons
	Case 1	Case 2	Case 3
CEO	<del>D</del>	E	E
Manager		D	
HR			D
Supervisor	<del>E</del>	A	A
Team Lead	<del>G</del>		
Executive	<del>B</del>	G	F
Accountant	<del>A</del>	B	G
Clerk		F	B
Peon			

**Clues:** I is designated senior to C and H. I is not designated as HR. H is designated junior to C

**Inference:** Case 2 gets cancelled here:

Designations	Persons	Persons
	Case 2	Case 3
CEO	<del>E</del>	E
Manager	<del>D</del>	I
HR	<del>I</del>	D
Supervisor	<del>A</del>	A
Team Lead	<del>G</del>	C
Executive	<del>G</del>	F
Accountant	<del>B</del>	G
Clerk	<del>F</del>	B
Peon	<del>H</del>	H

**Inference:** Now, the final Arrangement is here:

Designations	Persons
CEO	E
Manager	I
HR	D
Supervisor	A
Team Lead	C
Executive	F
Accountant	G
Clerk	B
Peon	H

All are true

**S86. Ans.(d)**

**Sol.** Final Arrangement:

Designations	Persons
CEO	E
Manager	I
HR	D
Supervisor	A
Team Lead	C
Executive	F
Accountant	G
Clerk	B
Peon	H

**Clues:** D is four designations senior to G. G is designated immediately senior to B who is not peon. Two persons are designated between A and E. E is senior to A.

**Inference:** We have three possible cases here:

Designations	Persons	Persons	Persons
	Case 1	Case 2	Case 3
CEO	D	E/	E/
Manager		D	E/
HR			D
Supervisor	E	A/	A/
Team Lead	G	E/	A/
Executive	B	G	E/
Accountant	A	B	G
Clerk		A/	B
Peon			A/

**Clues:** F is designated junior to A but not immediately junior. F is not designated as the junior most person.

**Inference:** Case 1 gets cancelled here:

Designations	Persons	Persons	Persons
	Case 1	Case 2	Case 3
CEO	D	E	E
Manager		D	
HR			D
Supervisor	E	A	A
Team Lead	G		
Executive	B	G	F
Accountant	A	B	G
Clerk		F	B
Peon			

**Clues:** I is designated senior to C and H. I is not designated as HR. H is designated junior to C

**Inference:** Case 2 gets cancelled here:

Designations	Persons	Persons
	Case 2	Case 3
CEO	E	E
Manager	D	I
HR	I	D
Supervisor	A	A
Team Lead	G	C
Executive	G	F
Accountant	B	G
Clerk	F	B
Peon	H	H

**Inference:** Now, the final Arrangement is here:

Designations	Persons
CEO	E
Manager	I
HR	D
Supervisor	A
Team Lead	C
Executive	F
Accountant	G
Clerk	B
Peon	H

'D - Team Lead' is not correct

**S87. Ans.(b)**

**Sol. 278531519 = 367642628**

3748 = 7+3 = 10

S88. Ans.(c)

Sol.Final Arrangement is here:

Days	Persons	Fruits
Monday	G	Apple
Tuesday	E	Guava
Wednesday	J	Mango
Thursday	H	Grape
Friday	D	Orange
Saturday	K	Pear
Sunday	F	Litchi

**Clues:** E goes to purchase fruit immediately before J. Three persons purchase fruits between J and the one who purchased Litchi. J purchased fruit before the one who purchased litchi. The number of persons go to purchase fruit after E is same as the number of persons go to purchase fruit before K who purchased Pear.

**Inference:** We have two possible cases here:

Days	Case 1		Case 2	
	Persons	Fruits	Persons	Fruits
Monday	E			
Tuesday	J		E	
Wednesday			J	
Thursday				
Friday				
Saturday		Litchi	K	Pear
Sunday	K	Pear		Litchi

**Clues:** Three persons go to purchase fruit between K and the one who purchase Guava. The one who go to purchase guava purchased it two persons before H. D purchased Orange. D purchased the fruit after J.

**Inference:**

Days	Case 1		Case 2	
	Persons	Fruits	Persons	Fruits
Monday	E			
Tuesday	J		E	Guava
Wednesday		Guava	J	
Thursday	D	Orange	H	
Friday	H		D	Orange
Saturday		Litchi	K	Pear
Sunday	K	Pear		Litchi

**Clues:** As many persons purchased between the ones who purchased Orange and Mango as between Mango and G. Apple was purchased before Grape but not immediately before.

**Inference:** Case 1 gets cancelled here.

Days	Case 1		Case 2	
	Persons	Fruits	Persons	Fruits
Monday	E		G	Apple
Tuesday	J		E	Guava
Wednesday		Guava	J	Mango
Thursday	D	Orange	H	Grape
Friday	H	Mango	D	Orange
Saturday	G	Litchi	K	Pear
Sunday	K	Pear		Litchi

**Inference:** Only place for F is left. Final Arrangement is here:

Days	Persons	Fruits
Monday	G	Apple
Tuesday	E	Guava
Wednesday	J	Mango
Thursday	H	Grape
Friday	D	Orange
Saturday	K	Pear
Sunday	F	Litchi

'G- Apple' is correct

**S89. Ans.(d)**

**Sol.**Final Arrangement is here:

Days	Persons	Fruits
Monday	G	Apple
Tuesday	E	Guava
Wednesday	J	Mango
Thursday	H	Grape
Friday	D	Orange
Saturday	K	Pear
Sunday	F	Litchi



**Clues:** E goes to purchase fruit immediately before J. Three persons purchase fruits between J and the one who purchased Litchi. J purchased fruit before the one who purchased litchi. The number of persons go to purchase fruit after E is same as the number of persons go to purchase fruit before K who purchased Pear.

**Inference:** We have two possible cases here:

Days	Case 1		Case 2	
	Persons	Fruits	Persons	Fruits
Monday	E			
Tuesday	J		E	
Wednesday			J	
Thursday				
Friday				
Saturday		Litchi	K	Pear
Sunday	K	Pear		Litchi

**Clues:** Three persons go to purchase fruit between K and the one who purchase Guava. The one who go to purchase guava purchased it two persons before H. D purchased Orange. D purchased the fruit after J.

**Inference:**

Days	Case 1		Case 2	
	Persons	Fruits	Persons	Fruits
Monday	E			
Tuesday	J		E	Guava
Wednesday		Guava	J	
Thursday	D	Orange	H	
Friday	H		D	Orange
Saturday		Litchi	K	Pear
Sunday	K	Pear		Litchi

**Clues:** As many persons purchased between the ones who purchased Orange and Mango as between Mango and G. Apple was purchased before Grape but not immediately before.

**Inference:** Case 1 gets cancelled here.

Days	Case 1		Case 2	
	Persons	Fruits	Persons	Fruits
Monday	E		G	Apple
Tuesday	J		E	Guava
Wednesday		Guava	J	Mango
Thursday	D	Orange	H	Grape
Friday	H	Mango	D	Orange
Saturday	G	Litchi	K	Pear
Sunday	K	Pear		Litchi

**Inference:** Only place for F is left. Final Arrangement is here:

Days	Persons	Fruits
Monday	G	Apple
Tuesday	E	Guava
Wednesday	J	Mango
Thursday	H	Grape
Friday	D	Orange
Saturday	K	Pear
Sunday	F	Litchi

K is related to Litchi.

**S90. Ans.(b)**

**Sol.** Final Arrangement is here:

Days	Persons	Fruits
Monday	G	Apple
Tuesday	E	Guava
Wednesday	J	Mango
Thursday	H	Grape
Friday	D	Orange
Saturday	K	Pear
Sunday	F	Litchi

**Clues:** E goes to purchase fruit immediately before J. Three persons purchase fruits between J and the one who purchased Litchi. J purchased fruit before the one who purchased litchi. The number of persons go to purchase fruit after E is same as the number of persons go to purchase fruit before K who purchased Pear.

**Inference:** We have two possible cases here:

Days	Case 1		Case 2	
	Persons	Fruits	Persons	Fruits
Monday	E			
Tuesday	J		E	
Wednesday			J	
Thursday				
Friday				
Saturday		Litchi	K	Pear
Sunday	K	Pear		Litchi

**Clues:** Three persons go to purchase fruit between K and the one who purchase Guava. The one who go to purchase guava purchased it two persons before H. D purchased Orange. D purchased the fruit after J.

**Inference:**

Days	Case 1		Case 2	
	Persons	Fruits	Persons	Fruits
Monday	E			
Tuesday	J		E	Guava
Wednesday		Guava	J	
Thursday	D	Orange	H	
Friday	H		D	Orange
Saturday		Litchi	K	Pear
Sunday	K	Pear		Litchi

**Clues:** As many persons purchased between the ones who purchased Orange and Mango as between Mango and G. Apple was purchased before Grape but not immediately before.

**Inference:** Case 1 gets cancelled here.

Days	Case-1		Case 2	
	Persons	Fruits	Persons	Fruits
Monday	<del>E</del>		G	Apple
Tuesday	<del>J</del>		E	Guava
Wednesday		<del>Guava</del>	J	Mango
Thursday	<del>D</del>	<del>Orange</del>	H	Grape
Friday	<del>H</del>	<del>Mango</del>	D	Orange
Saturday	<del>G</del>	<del>Litchi</del>	K	Pear
Sunday	<del>K</del>	<del>Pear</del>		Litchi

**Inference:** Only place for F is left. Final Arrangement is here:



Days	Persons	Fruits
Monday	G	Apple
Tuesday	E	Guava
Wednesday	J	Mango
Thursday	H	Grape
Friday	D	Orange
Saturday	K	Pear
Sunday	F	Litchi

Four

**S91. Ans.(b)**

**Sol.** Final Arrangement is here:

Days	Persons	Fruits
Monday	G	Apple
Tuesday	E	Guava
Wednesday	J	Mango
Thursday	H	Grape
Friday	D	Orange
Saturday	K	Pear
Sunday	F	Litchi

**Clues:** E goes to purchase fruit immediately before J. Three persons purchase fruits between J and the one who purchased Litchi. J purchased fruit before the one who purchased litchi. The number of persons go to purchase fruit after E is same as the number of persons go to purchase fruit before K who purchased Pear.

**Inference:** We have two possible cases here:

Days	Case 1		Case 2	
	Persons	Fruits	Persons	Fruits
Monday	E			
Tuesday	J		E	
Wednesday			J	
Thursday				
Friday				
Saturday		Litchi	K	Pear
Sunday	K	Pear		Litchi

**Clues:** Three persons go to purchase fruit between K and the one who purchase Guava. The one who go to purchase guava purchased it two persons before H. D purchased Orange. D purchased the fruit after J.

**Inference:**

Days	Case 1		Case 2	
	Persons	Fruits	Persons	Fruits
Monday	E			
Tuesday	J		E	Guava
Wednesday		Guava	J	
Thursday	D	Orange	H	
Friday	H		D	Orange
Saturday		Litchi	K	Pear
Sunday	K	Pear		Litchi

**Clues:** As many persons purchased between the ones who purchased Orange and Mango as between Mango and G. Apple was purchased before Grape but not immediately before.

**Inference:** Case 1 gets cancelled here.

Days	Case 1		Case 2	
	Persons	Fruits	Persons	Fruits
Monday	E		G	Apple
Tuesday	J		E	Guava
Wednesday		Guava	J	Mango
Thursday	D	Orange	H	Grape
Friday	H	Mango	D	Orange
Saturday	G	Litchi	K	Pear
Sunday	K	Pear		Litchi

**Inference:** Only place for F is left. Final Arrangement is here:

Days	Persons	Fruits
Monday	G	Apple
Tuesday	E	Guava
Wednesday	J	Mango
Thursday	H	Grape
Friday	D	Orange
Saturday	K	Pear
Sunday	F	Litchi

K purchased fruit on Saturday.

S92. Ans.(c)

Sol. Final Arrangement is here:

Days	Persons	Fruits
Monday	G	Apple
Tuesday	E	Guava
Wednesday	J	Mango
Thursday	H	Grape
Friday	D	Orange
Saturday	K	Pear
Sunday	F	Litchi

**Clues:** E goes to purchase fruit immediately before J. Three persons purchase fruits between J and the one who purchased Litchi. J purchased fruit before the one who purchased litchi. The number of persons go to purchase fruit after E is same as the number of persons go to purchase fruit before K who purchased Pear.

**Inference:** We have two possible cases here:

Days	Case 1		Case 2	
	Persons	Fruits	Persons	Fruits
Monday	E			
Tuesday	J		E	
Wednesday			J	
Thursday				
Friday				
Saturday		Litchi	K	Pear
Sunday	K	Pear		Litchi

**Clues:** Three persons go to purchase fruit between K and the one who purchase Guava. The one who go to purchase guava purchased it two persons before H. D purchased Orange. D purchased the fruit after J.

**Inference:**

Days	Case 1		Case 2	
	Persons	Fruits	Persons	Fruits
Monday	E			
Tuesday	J		E	Guava
Wednesday		Guava	J	
Thursday	D	Orange	H	
Friday	H		D	Orange
Saturday		Litchi	K	Pear
Sunday	K	Pear		Litchi

**Clues:** As many persons purchased between the ones who purchased Orange and Mango as between Mango and G. Apple was purchased before Grape but not immediately before.

**Inference:** Case 1 gets cancelled here.

Days	Case 1		Case 2	
	Persons	Fruits	Persons	Fruits
Monday	<del>E</del>		G	Apple
Tuesday	<del>J</del>		E	Guava
Wednesday		Guava	J	Mango
Thursday	<del>D</del>	Orange	H	Grape
Friday	<del>H</del>	Mango	D	Orange
Saturday	<del>G</del>	Litchi	K	Pear
Sunday	<del>K</del>	Pear		Litchi



**Inference:** Only place for F is left. Final Arrangement is here:

Days	Persons	Fruits
Monday	G	Apple
Tuesday	E	Guava
Wednesday	J	Mango
Thursday	H	Grape
Friday	D	Orange
Saturday	K	Pear
Sunday	F	Litchi

Guava

**S93. Ans.(a)**

**Sol.** I.  $M < W$  (True)

II.  $Z > V$  (False)

**S94. Ans.(a)**

**Sol.** I.  $X > L$  (True)

II.  $P \geq Q$  (False)

**S95. Ans.(c)**

**Sol.** I.  $T < W$  (False)

II.  $W \leq M$  (False)

But both conclusion satisfy the either-or case

**S96. Ans.(b)**

**Sol. Final arrangement:**

Boxes
F
A
E
D
B
I
C
G
H

**Clues:** Five boxes are placed between box G and box A. Box D is placed two boxes below box A. Number of boxes placed between box D and box G is three more than the number of boxes placed below box H.

**Inference:** Here, we have three possible cases:

Boxes	Boxes	Boxes
Case 1	Case 2	Case 3
G	A	
		A
	D	
		D
H		
A	G	
		G
D	H	H

**Clues:** One box is placed between box H and box C.

**Inference:** Case 2 gets cancelled here because there is no place for box C.

Boxes	Boxes	Boxes
Case 1	Case 2	Case 3
G	A	
		A
C	D	
		D
H		
A	G	C
		G
D	H	H

**Clues:** Box F is placed five boxes above box I.

**Inference:** Case 1 gets cancelled here because there is no place for box F and I.

Boxes	Boxes
Case 1	Case 3
G	F
	A
G	
	D
H	
	I
A	C
	G
D	H

**Clue:** Box B is not placed above box E.

**Inference:** Now, the final arrangement is:

Boxes
F
A
E
D
B
I
C
G
H

Fifth

S97. Ans.(d)

Sol. Final arrangement:

Boxes
F
A
E
D
B
I
C
G
H

**Clues:** Five boxes are placed between box G and box A. Box D is placed two boxes below box A. Number of boxes placed between box D and box G is three more than the number of boxes placed below box H.

**Inference:** Here, we have three possible cases:

Boxes Case 1	Boxes Case 2	Boxes Case 3
G	A	
		A
	D	
		D
H		
A	G	
		G
D	H	H

**Clues:** One box is placed between box H and box C.

**Inference:** Case 2 gets cancelled here because there is no place for box C.

Boxes Case 1	<del>Boxes Case-2</del>	Boxes Case 3
G	<del>A</del>	
		A
C	<del>D</del>	
		D
H		
A	<del>G</del>	C
		G
D	<del>H</del>	H

**Clues:** Box F is placed five boxes above box I.

**Inference:** Case 1 gets cancelled here because there is no place for box F and I.

<b>Boxes</b>	<b>Boxes</b>
<b>Case 1</b>	<b>Case 3</b>
G	F
	A
G	
	D
H	
	I
A	C
	G
D	H

**Clue:** Box B is not placed above box E.

**Inference:** Now, the final arrangement is:

<b>Boxes</b>
F
A
E
D
B
I
C
G
H

Five

**S98. Ans.(a)**

**Sol. Final arrangement:**

<b>Boxes</b>
F
A
E
D
B
I
C
G
H

**Clues:** Five boxes are placed between box G and box A. Box D is placed two boxes below box A. Number of boxes placed between box D and box G is three more than the number of boxes placed below box H.

**Inference:** Here, we have three possible cases:

Boxes Case 1	Boxes Case 2	Boxes Case 3
G	A	
		A
	D	
		D
H		
A	G	
		G
D	H	H

**Clues:** One box is placed between box H and box C.

**Inference:** Case 2 gets cancelled here because there is no place for box C.

Boxes Case 1	<del>Boxes Case 2</del>	Boxes Case 3
G	<del>A</del>	
		A
C	<del>D</del>	
		D
H		
A	<del>G</del>	C
		G
D	<del>H</del>	H

**Clues:** Box F is placed five boxes above box I.

**Inference:** Case 1 gets cancelled here because there is no place for box F and I.

<del>Boxes Case 1</del>	Boxes Case 3
<del>G</del>	F
	A
<del>G</del>	
	D
<del>H</del>	
	I
<del>A</del>	C
	G
<del>D</del>	H

**Clue:** Box B is not placed above box E.



**Inference:** Now, the final arrangement is:

Boxes
F
A
E
D
B
I
C
G
H

The number of boxes placed above box D and below box I are same.

**S99. Ans.(e)**

**Sol. Final arrangement:**

Boxes
F
A
E
D
B
I
C
G
H

**Clues:** Five boxes are placed between box G and box A. Box D is placed two boxes below box A. Number of boxes placed between box D and box G is three more than the number of boxes placed below box H.

**Inference:** Here, we have three possible cases:

Boxes	Boxes	Boxes
Case 1	Case 2	Case 3
G	A	
		A
	D	
		D
H		
A	G	
		G
D	H	H

**Clues:** One box is placed between box H and box C.

**Inference:** Case 2 gets cancelled here because there is no place for box C.

Boxes	Boxes	Boxes
Case 1	Case-2	Case 3
G	A	
		A
C	D	
		D
H		
A	G	C
		G
D	H	H

**Clues:** Box F is placed five boxes above box I.

**Inference:** Case 1 gets cancelled here because there is no place for box F and I.

Boxes	Boxes
Case-1	Case 3
G	F
	A
G	
	D
H	
	I
A	C
	G
D	H

**Clue:** Box B is not placed above box E.

**Inference:** Now, the final arrangement is:

Boxes
F
A
E
D
B
I
C
G
H

except 'A-H', all are adjacent boxes

S100. Ans.(c)

Sol. Final arrangement:

Boxes
F
A
E
D
B
I
C
G
H

**Clues:** Five boxes are placed between box G and box A. Box D is placed two boxes below box A. Number of boxes placed between box D and box G is three more than the number of boxes placed below box H.

**Inference:** Here, we have three possible cases:

Boxes Case 1	Boxes Case 2	Boxes Case 3
G	A	
		A
	D	
		D
H		
A	G	
		G
D	H	H

**Clues:** One box is placed between box H and box C.

**Inference:** Case 2 gets cancelled here because there is no place for box C.

Boxes Case 1	<del>Boxes Case-2</del>	Boxes Case 3
G	<del>A</del>	
		A
C	<del>D</del>	
		D
H		
A	<del>G</del>	C
		G
D	<del>H</del>	H

**Clues:** Box F is placed five boxes above box I.

**Inference:** Case 1 gets cancelled here because there is no place for box F and I.

Boxes	Boxes
Case-1	Case 3
G	F
	A
G	
	D
H	
	I
A	C
	G
D	H

**Clue:** Box B is not placed above box E.

**Inference:** Now, the final arrangement is:

Boxes
F
A
E
D
B
I
C
G
H

Only II

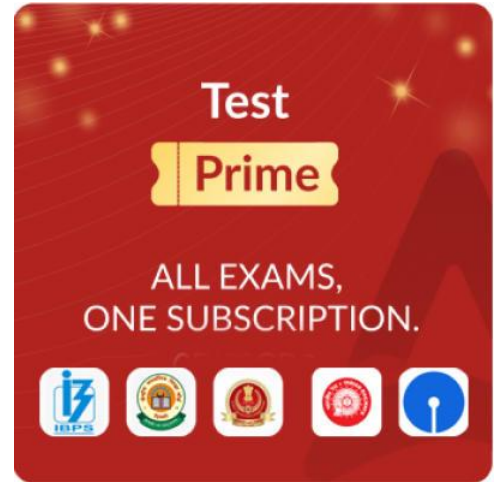

Test  
Prime

ALL EXAMS,  
ONE SUBSCRIPTION.

