

Reasoning - Seating Arrangement Questions For RBI Grade B Phase I Exam 2026

Directions {1-5}: Study the following information carefully and answer the questions given below: Fourteen persons are seated in two parallel rows, with seven persons in each row. The persons in Row 1 (A, B, C, D, E, F, G) sit facing north, while the persons in Row 2 (H, I, J, K, L, M, N) sit facing south. Each person in Row 1 faces exactly one person in Row 2, and vice versa. But not necessarily in the same order. C sits fourth to the left of B. Neither C nor B sit at the end of the row. The person who sits opposite to C is an immediate neighbor of J. L sits at the extreme end of the row. Three persons sit between J and K. The one who sits opposite to D sits third to the left of N. D doesn't sit at the end of the row. Three persons sit between D and the one who faces J. E sits immediate right of G. Four persons sit between H and the one who faces F. I doesn't face G.

Q1. Who among the following sits third to the right of the persons who sits opposite to B?

- (a). M
- (b). I
- (c). H
- (d). N
- (e). L

Ans.(a)

Sol. Final arrangement is here:

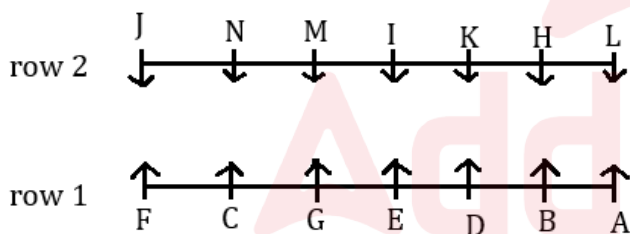

Clues: C sits fourth to the left of B. Neither C nor B sit at the end of the row. The person who sits opposite to C is an immediate neighbor of J. L sits at the extreme end of the row.

Inference: From the above condition we have two possible cases here:

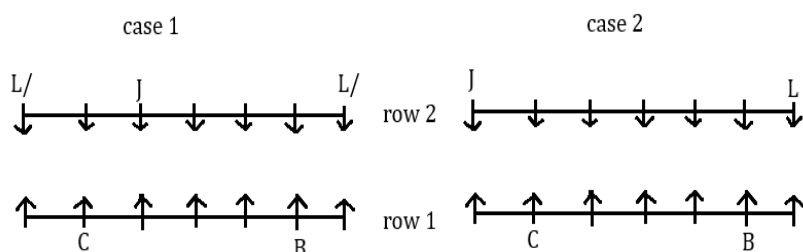

Clues: Three persons sit between J and K. The one who sits opposite to D sits third to the left of N. D doesn't sit at the end of the row. Three persons sit between D and the one who faces J.

Inference: From the above condition case 1 gets eliminated here, because no place for D

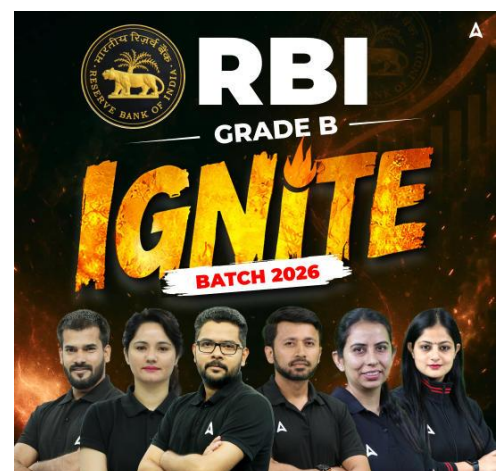

case 1

case 2

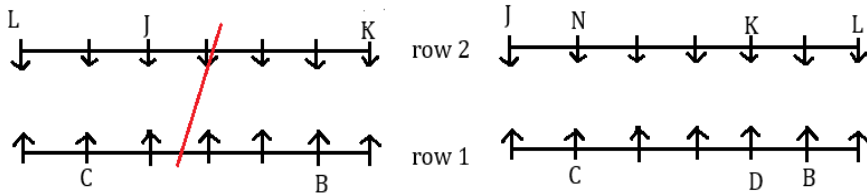

Clues: E sits immediate right of G. Four persons sit between H and the one who faces F. I doesn't face G.

Inference: Above clues are arranged here:



Inference: Persons A and M are left after placing both final arrangement is here:

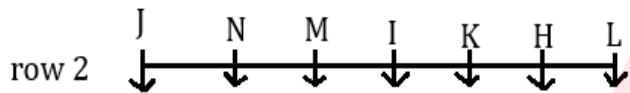

M sits third to the right of the persons who sits opposite to B

Q2. What is the position of the person who sits opposite to N with respect to F?

- (a). Third to the right
- (b). Immediate right
- (c). Third to the left
- (d). Fourth to the left
- (e). Second to the left

Ans.(b)

Sol. Final arrangement is here:

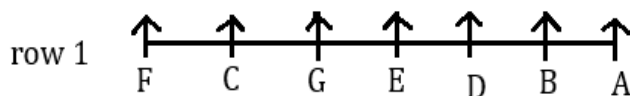
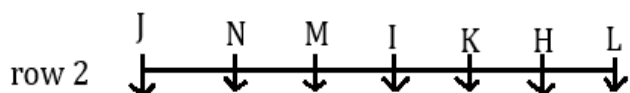

Clues: C sits fourth to the left of B. Neither C nor B sit at the end of the row. The person who sits opposite to C is an immediate neighbor of J. L sits at the extreme end of the row.

Inference: From the above condition we have two possible cases here:

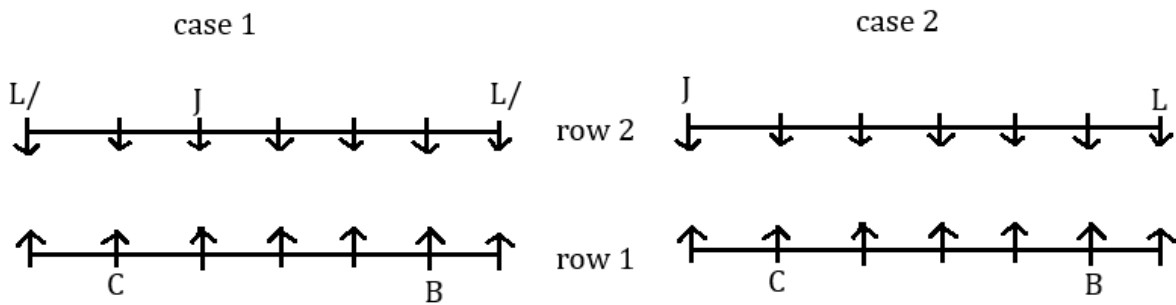

Clues: Three persons sit between J and K. The one who sits opposite to D sits third to the left of N. D doesn't sit at the end of the row. Three persons sit between D and the one who faces J.

Inference: From the above condition case 1 gets eliminated here, because no place for D

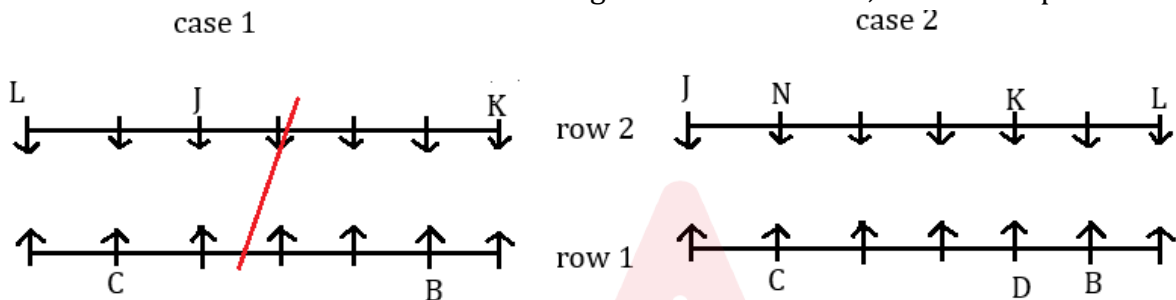

Clues: E sits immediate right of G. Four persons sit between H and the one who faces F. I doesn't face G.

Inference: Above clues are arranged here:

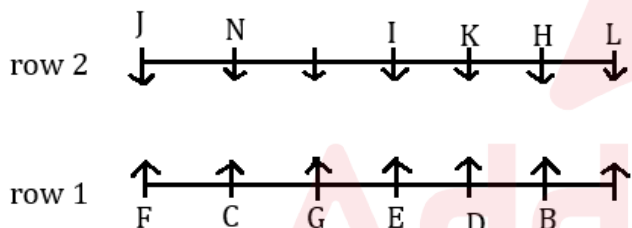

Inference: Persons A and M are left after placing both final arrangement is here:

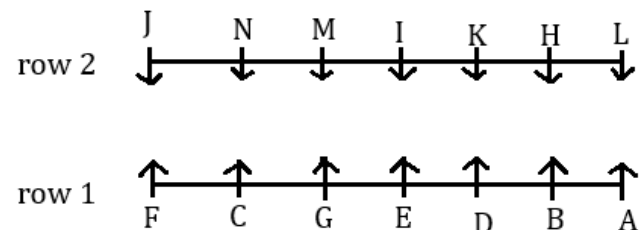

C sits opposite to N and sits immediate right of F

Q3. If C and D interchanged their positions and in the same way K and N interchanged their positions then who among the following sits opposite to C?

- (a). L
- (b). K
- (c). N
- (d). J
- (e). I

Ans.(c)

Sol. Final arrangement is here:

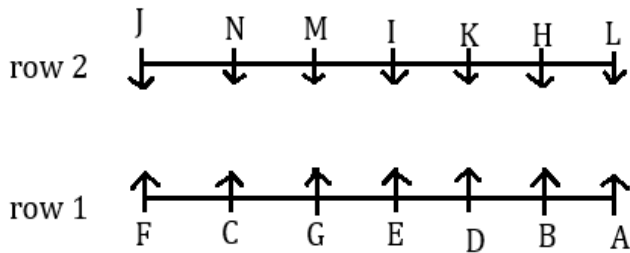

Clues: C sits fourth to the left of B. Neither C nor B sit at the end of the row. The person who sits opposite to C is an immediate neighbor of J. L sits at the extreme end of the row.

Inference: From the above condition we have two possible cases here:

case 1

case 2

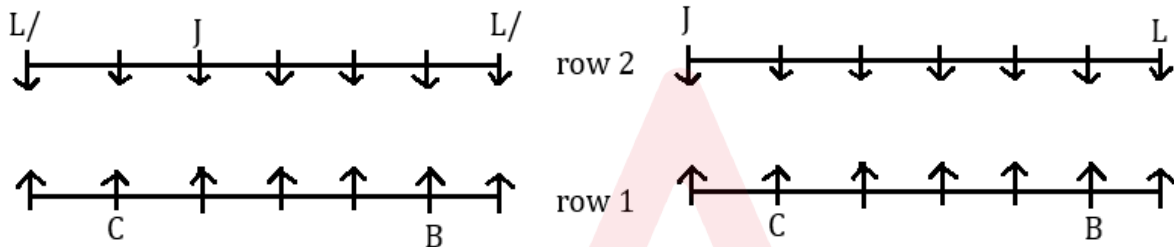

Clues: Three persons sit between J and K. The one who sits opposite to D sits third to the left of N. D doesn't sit at the end of the row. Three persons sit between D and the one who faces J.

Inference: From the above condition case 1 gets eliminated here, because no place for D

case 1

case 2

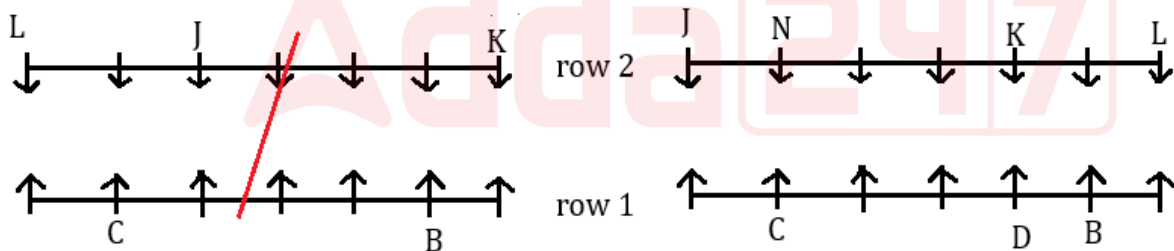

Clues: E sits immediate right of G. Four persons sit between H and the one who faces F. I doesn't face G.

Inference: Above clues are arranged here:

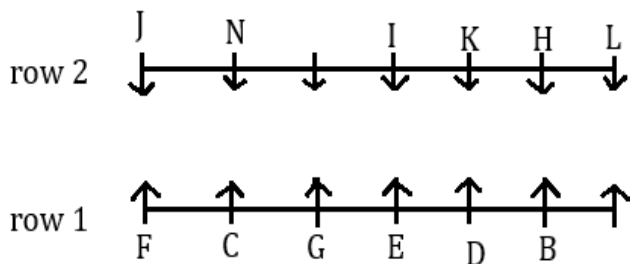

Inference: Persons A and M are left after placing both final arrangement is here:

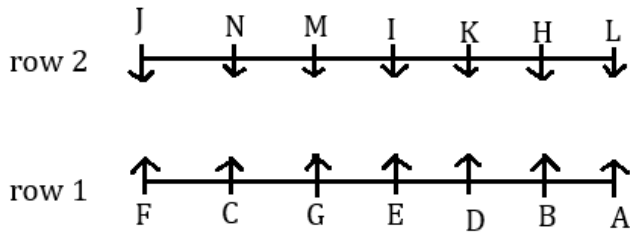

After interchanging the positions N sits opposite to C

Q4. Which of the following pairs are sit at extreme ends of the row?

- (a). B and M
- (b). J and E
- (c). L and G
- (d). J and F
- (e). None of these

Ans.(d)

Sol. Final arrangement is here:

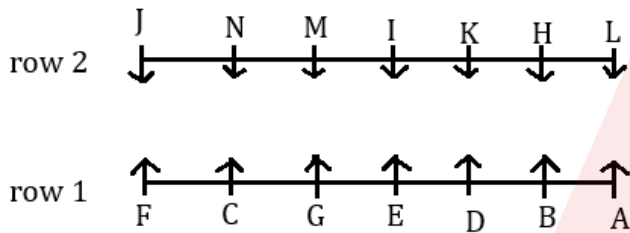

Clues: C sits fourth to the left of B. Neither C nor B sit at the end of the row. The person who sits opposite to C is an immediate neighbor of J. L sits at the extreme end of the row.

Inference: From the above condition we have two possible cases here:

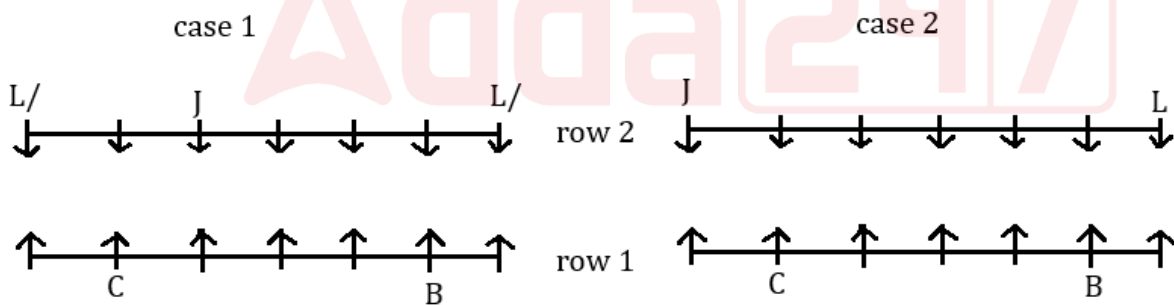

Clues: Three persons sit between J and K. The one who sits opposite to D sits third to the left of N. D doesn't sit at the end of the row. Three persons sit between D and the one who faces J.

Inference: From the above condition case 1 gets eliminated here, because no place for D

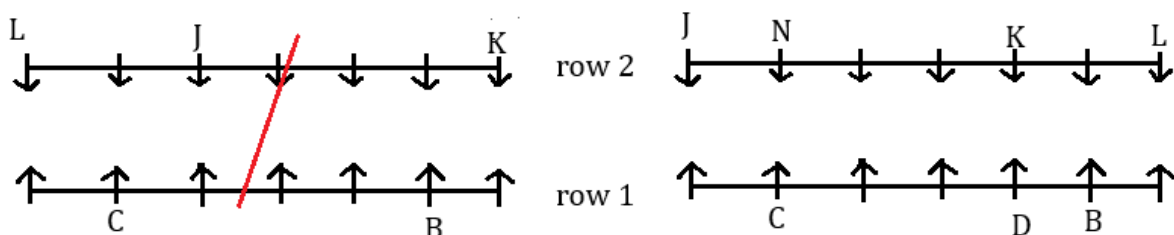

Clues: E sits immediate right of G. Four persons sit between H and the one who faces F. I doesn't face G.

Inference: Above clues are arranged here:

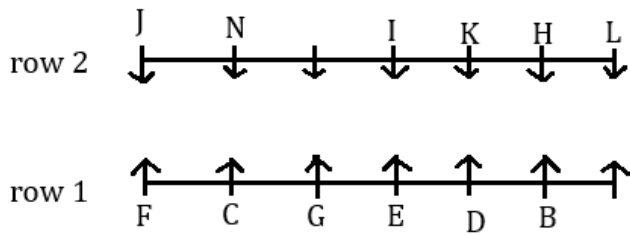

Inference: Persons A and M are left after placing both final arrangement is here:

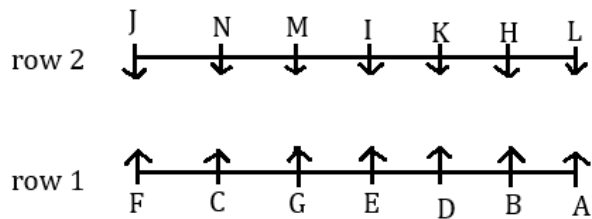

J and F sit at extreme ends of the row

Q5. Four of the following five are in the same group. Which among the following does not belong to that group?

- (a). N
- (b). I
- (c). D
- (d). G
- (e). J

Ans.(e)

Sol. Final arrangement is here:

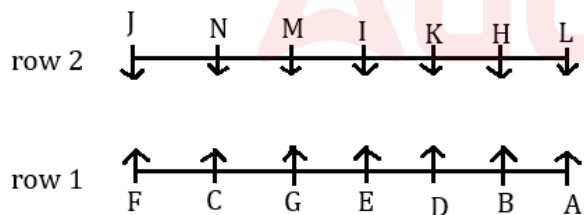

Clues: C sits fourth to the left of B. Neither C nor B sit at the end of the row. The person who sits opposite to C is an immediate neighbor of J. L sits at the extreme end of the row.

Inference: From the above condition we have two possible cases here:

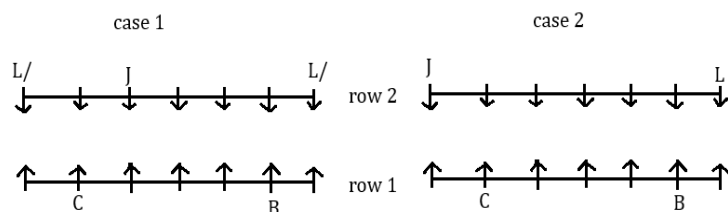

Clues: Three persons sit between J and K. The one who sits opposite to D sits third to the left of N. D doesn't sit at the end of the row. Three persons sit between D and the one who faces J.

Inference: From the above condition case 1 gets eliminated here, because no place for D

case 1

case 2

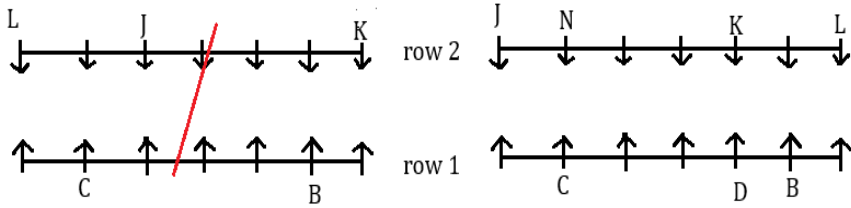

Clues: E sits immediate right of G. Four persons sit between H and the one who faces F. I doesn't face G.

Inference: Above clues are arranged here:

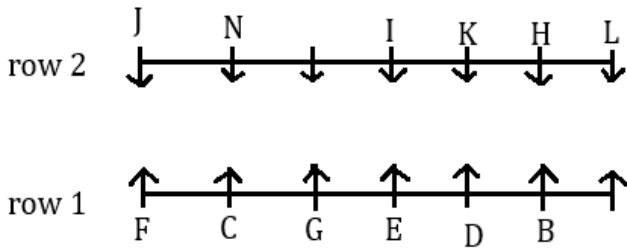

Inference: Persons A and M are left after placing both final arrangement is here:

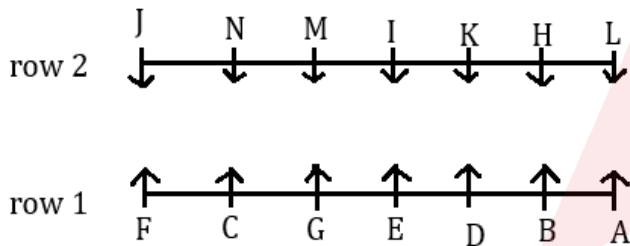

Except J, all other sit in the middle of the row

Directions {6-9}: Study the following information carefully and answer the question given below:

Six persons G, H, I, J, K and L sit around a hexagonal table and face inside but not necessarily in the same order. Each person has a different number of items i.e., 4, 7, 12, 9, 13 and 21 but not necessarily in the same order. Each person sits at the corner of the table.

One person sits between G and the person who has 7 items. L has more number of items than G. Two persons sit between G and K who have 12 items. One person sits between L and the person who has 4 Items. K and L do not sit adjacent to each other. L does not sit to the immediate left of G. The difference between the number of items of H and K is equal to the number of persons sit between J and H when counted from the right of H. J does not have 4 items. H does not have 13 items.

Q6. How many items does G have?

- (a). 4
- (b). 9
- (c). 13
- (d). Either 13 or 9
- (e). None of these

Ans.(c)

Sol. Final arrangement:

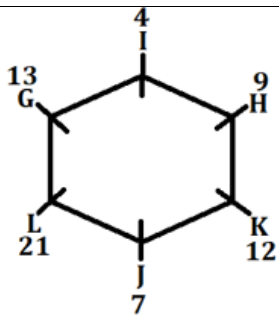

Clues: One person sits between G and the person who has 7 items. Two persons sit between G and K who has 12 items.

Inference: From the above conditions there are two possibilities i.e., Case 1 and Case 2.

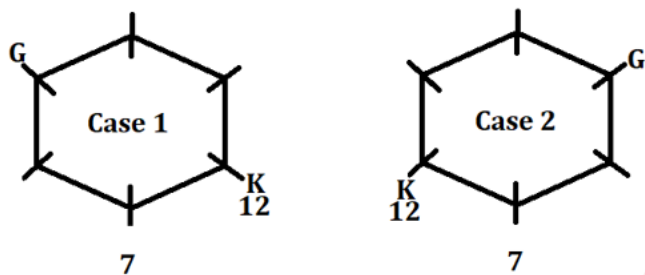

Clues: One person sits between L and the person who has 4 Items. K and L do not sit adjacent to each other. L does not sit to the immediate left of G.

Inference: From the above conditions it is clear that L and G sit adjacent to each other.

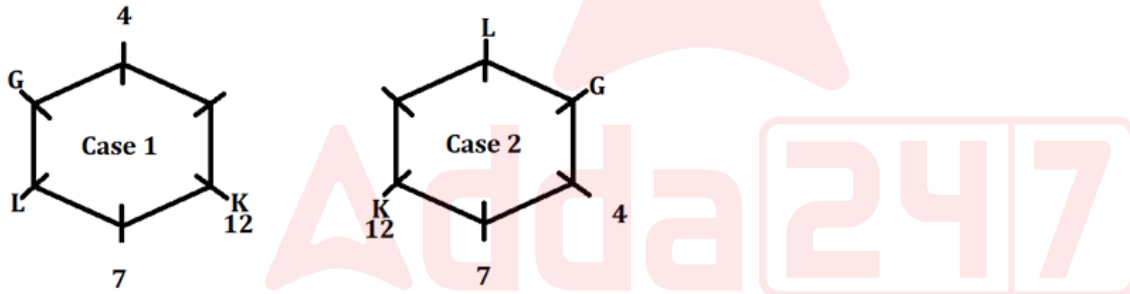

Clues: The difference between the number of items of H and K is equal to the number of persons sit between J and H when counted from the right of H. J does not have 4 items. H does not have 13 items.

Inference: From the above conditions Case 2 is cancelled here as there is no place for J and H. From the above conditions, it is clear that J has 7 items and H has 9 items.

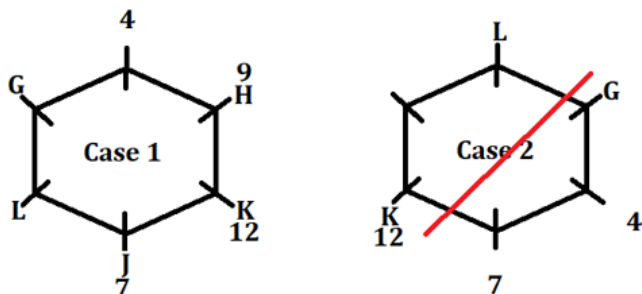

Clue: L has more number of items than G.

Inference: From the above conditions it is clear that G has 13 items and L has 21 items. Only one person remains i.e., I. So, the Final arrangement is:

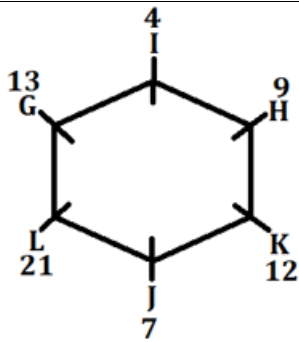

G has 13 items

Q7. What is the difference between the number of items of J and H?

- (a). 2
- (b). 4
- (c). 3
- (d). 5
- (e). None of these

Ans.(a)

Sol. Final arrangement:

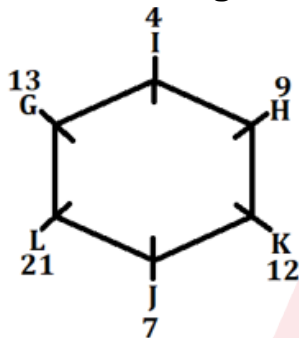

Clues: One person sits between G and the person who has 7 items. Two persons sit between G and K who has 12 items.

Inference: From the above conditions there are two possibilities i.e., Case 1 and Case 2.

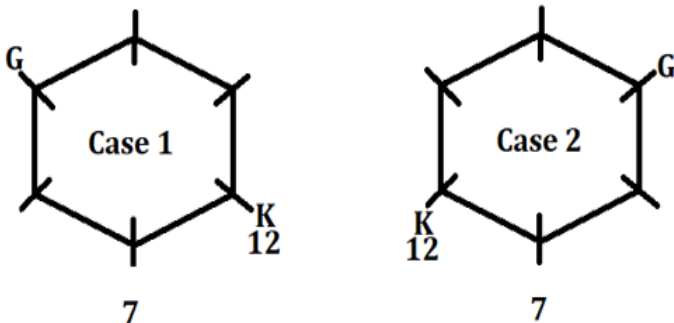

Clues: One person sits between L and the person who has 4 Items. K and L do not sit adjacent to each other. L does not sit to the immediate left of G.

Inference: From the above conditions it is clear that L and G sit adjacent to each other.

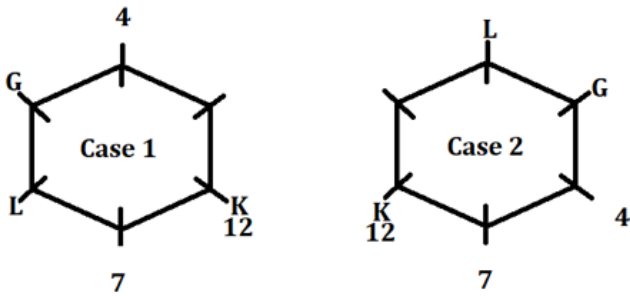

Clues: The difference between the number of items of H and K is equal to the number of persons sit between J and H when counted from the right of H. J does not have 4 items. H does not have 13 items.

Inference: From the above conditions Case 2 is cancelled here as there is no place for J and H. From the above conditions, it is clear that J has 7 items and H has 9 items.

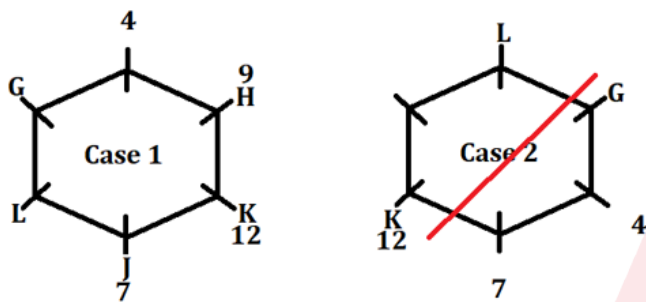

Clue: L has more number of items than G.

Inference: From the above conditions it is clear that G has 13 items and L has 21 items. Only one person remains i.e., I. So, the Final arrangement is:

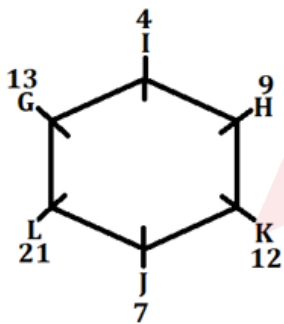

J has 7 items

H has 9 items

The difference between the items of J and H is 2

Q8. What is the position of K with respect to L?

- (a). Second to the left
- (b). Third to the left
- (c). Second to the right
- (d). Immediately right
- (e). None of these

Ans.(c)

Sol. Final arrangement:



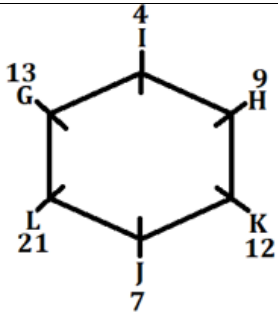

Clues: One person sits between G and the person who has 7 items. Two persons sit between G and K who has 12 items.

Inference: From the above conditions there are two possibilities i.e., Case 1 and Case 2.

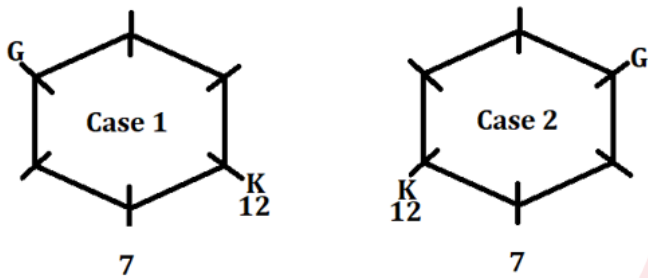

Clues: One person sits between L and the person who has 4 Items. K and L do not sit adjacent to each other. L does not sit to the immediate left of G.

Inference: From the above conditions it is clear that L and G sit adjacent to each other.

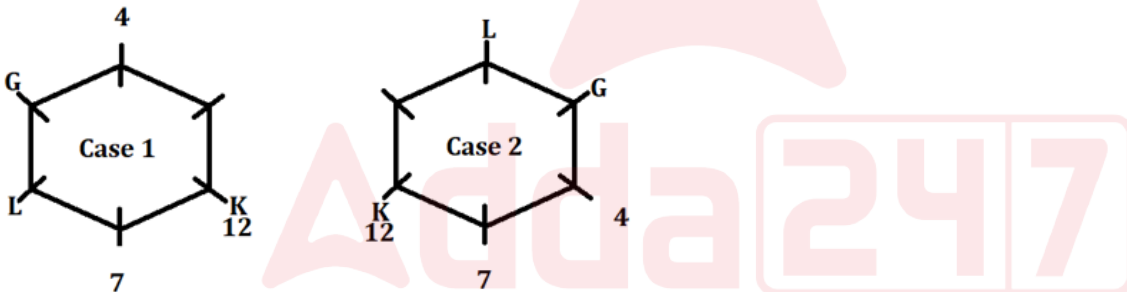

Clues: The difference between the number of items of H and K is equal to the number of persons sit between J and H when counted from the right of H. J does not have 4 items. H does not have 13 items.

Inference: From the above conditions Case 2 is cancelled here as there is no place for J and H. From the above conditions, it is clear that J has 7 items and H has 9 items.

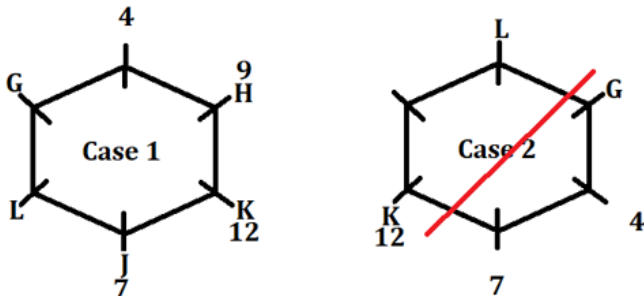

Clue: L has more number of items than G.

Inference: From the above conditions it is clear that G has 13 items and L has 21 items. Only one person remains i.e., I. So, the Final arrangement is:

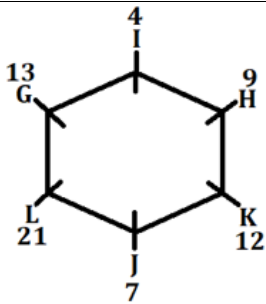

K sits second to the right of L

Q9. How many persons sit between I and K when counted from the left of I?

- (a). Two
- (b). Three
- (c). One
- (d). None
- (e). None of these

Ans.(c)

Sol. Final arrangement:

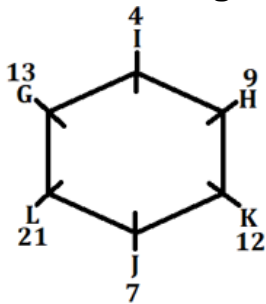

Clues: One person sits between G and the person who has 7 items. Two persons sit between G and K who has 12 items.

Inference: From the above conditions there are two possibilities i.e., Case 1 and Case 2.

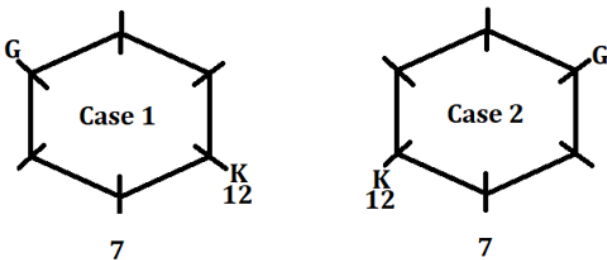

Clues: One person sits between L and the person who has 4 Items. K and L do not sit adjacent to each other. L does not sit to the immediate left of G.

Inference: From the above conditions it is clear that L and G sit adjacent to each other.

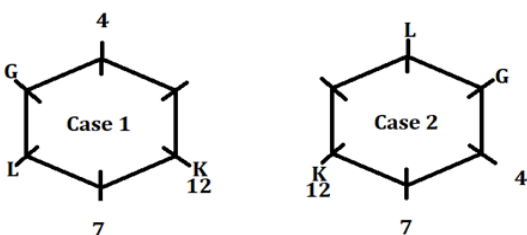

Clues: The difference between the number of items of H and K is equal to the number of persons sit between J and H when counted from the right of H. J does not have 4 items. H does not have 13 items.

Inference: From the above conditions Case 2 is cancelled here as there is no place for J and H. From the above conditions, it is clear that J has 7 items and H has 9 items.

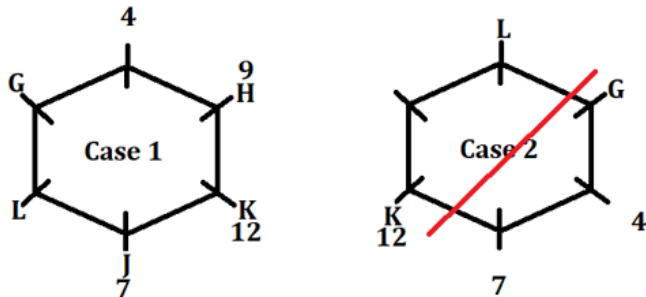

Clue: L has more number of items than G.

Inference: From the above conditions it is clear that G has 13 items and L has 21 items. Only one person remains i.e., I. So, the Final arrangement is:

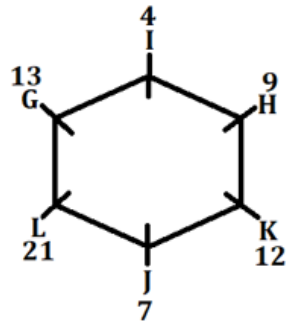

One person sits between I and K when counted from the left of I

Directions {10-14}: Study the following information carefully and answer the questions given below.

An uncertain number of persons are sitting in a linear row facing the north direction. R sits fourth to the right of S who is wearing a green shirt. The number of persons sitting between R and S is two more than the number of persons sitting between S and N. The one who is wearing blue shirt sits second to the left of N. H sits 2nd to the left of the one who is wearing blue shirt. J sits third to the right of H. Two persons sit between E and H. M and J are immediate neighbors. The one who is wearing red shirt sits 5th to the left of J. The number of persons sitting between H and the one who is wearing red shirt is one less than the number of persons sitting between A and the one who is wearing blue shirt. P sits 3rd to the left of A.

Q10. Four of the following five are alike in a certain way and thus form a group, then which among the following doesn't belong to that group?

- (a). P, E
- (b). J, N
- (c). M, J
- (d). A, H
- (e). J, S

Ans.(e)

Sol. Final arrangement:

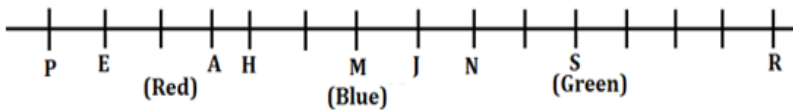

Explanation:

Clues:

R sits fourth to the right of S who is wearing a green shirt. The number of persons sitting between R and S is two more than the number of persons sitting between S and N.

Inference:

From these clues, we get two possible cases: -

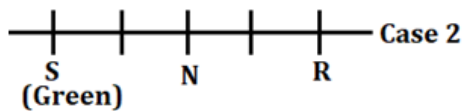
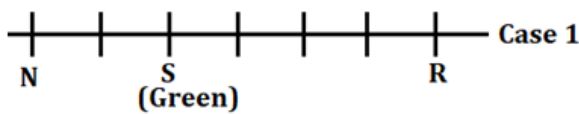

Clues:

The one who is wearing blue shirt sits second to the left of N. H sits 2nd to the left of the one who is wearing blue shirt.

Inference:

Case 2 will eliminate here because there is no place for the one who likes Blue.

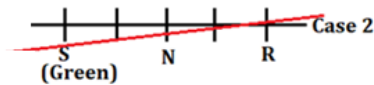
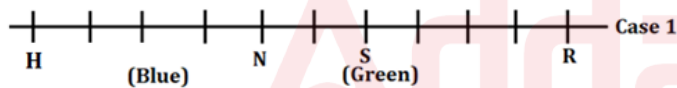

Clues:

J sits third to the right of H. Two persons sit between E and H. M and J are immediate neighbors. The one who is wearing red shirt sits 5th to the left of J.

Inference:

Thus, the one who is wearing red shirt is an immediate neighbour of E.

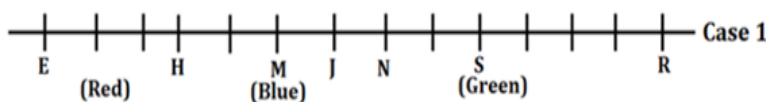

Clues:

The number of persons sitting between H and the one who is wearing red shirt is one less than the number of persons sitting between A and the one who is wearing blue shirt. P sits 3rd to the left of A.

Inference:

So, A will sit immediate left of H and thus the final arrangement: -

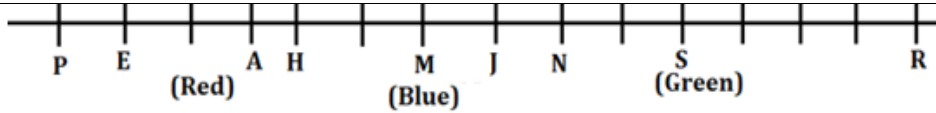

Except J and S, all of them sit adjacent to each other.

Q11. Number of persons sit between P and M is same as the number of persons sit between ____ and ____.

- (a). R, the one who is wearing green shirt
- (b). N, J
- (c). E, J
- (d). M, the one who is wearing red shirt
- (e). All of these

Ans.(c)

Sol. Final arrangement:

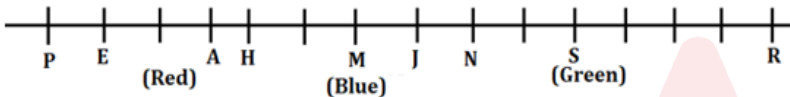

Explanation:

Clues:

R sits fourth to the right of S who is wearing a green shirt. The number of persons sitting between R and S is two more than the number of persons sitting between S and N.

Inference:

From these clues, we get two possible cases: -

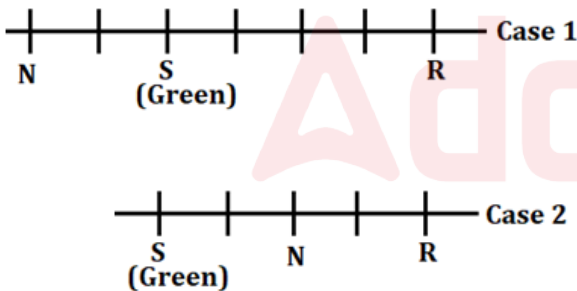

Clues:

The one who is wearing blue shirt sits second to the left of N. H sits 2nd to the left of the one who is wearing blue shirt.

Inference:

Case 2 will eliminate here because there is no place for the one who likes Blue.

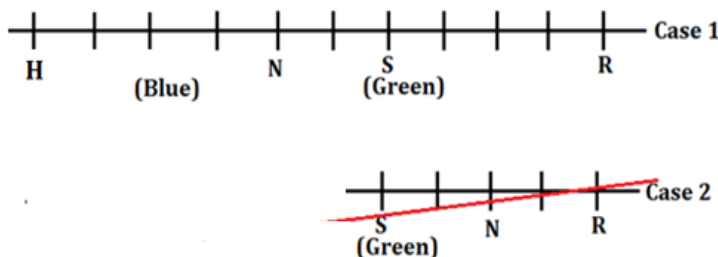

Clues:

J sits third to the right of H. Two persons sit between E and H. M and J are immediate neighbors. The one who is wearing red shirt sits 5th to the left of J.

Inference:

Thus, the one who is wearing red shirt is an immediate neighbour of E.

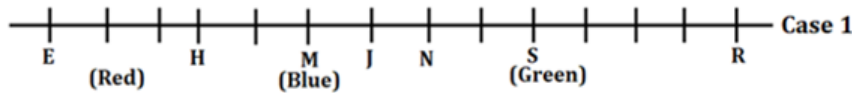

Clues:

The number of persons sitting between H and the one who is wearing red shirt is one less than the number of persons sitting between A and the one who is wearing blue shirt. P sits 3rd to the left of A.

Inference:

So, A will sit immediate left of H and thus the final arrangement: -

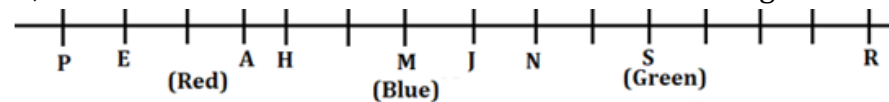

Number of persons sit between P and M is same as the number of persons sit between E and J.

Q12. Who among the following person is wearing the red shirt?

- (a). P
- (b). M
- (c). Unknown person
- (d). A
- (e). E

Ans.(c)

Sol. Final arrangement:

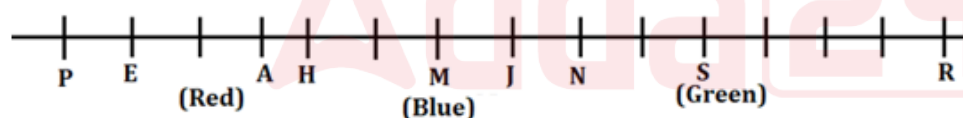

Explanation:

Clues:

R sits fourth to the right of S who is wearing a green shirt. The number of persons sitting between R and S is two more than the number of persons sitting between S and N.

Inference:

From these clues, we get two possible cases: -

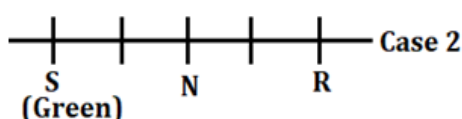
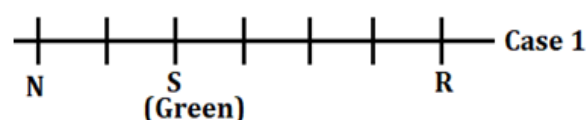

Clues:

The one who is wearing blue shirt sits second to the left of N. H sits 2nd to the left of the one who is wearing blue shirt.

Inference:

Case 2 will eliminate here because there is no place for the one who likes Blue.

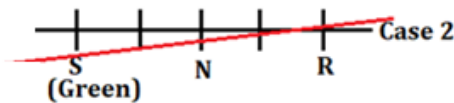
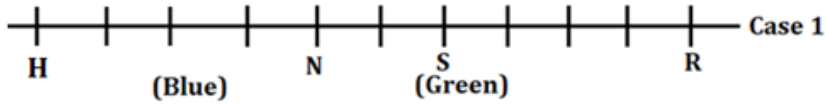

Clues:

J sits third to the right of H. Two persons sit between E and H. M and J are immediate neighbors. The one who is wearing red shirt sits 5th to the left of J.

Inference:

Thus, the one who is wearing red shirt is an immediate neighbour of E.

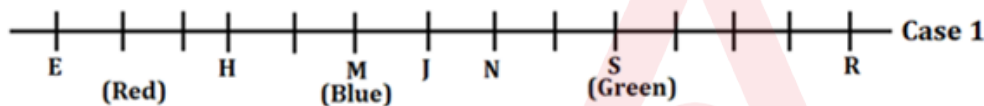

Clues:

The number of persons sitting between H and the one who is wearing red shirt is one less than the number of persons sitting between A and the one who is wearing blue shirt. P sits 3rd to the left of A.

Inference:

So, A will sit immediate left of H and thus the final arrangement: -

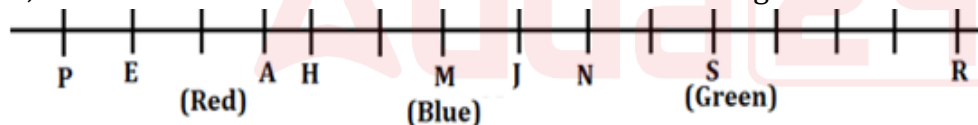

The one who is wearing red shirt is not known.

Q13. How many minimum numbers of persons are sitting in the row?

- (a). 15
- (b). 25
- (c). 16
- (d). 17
- (e). 13

Ans.(a)

Sol. Final arrangement:

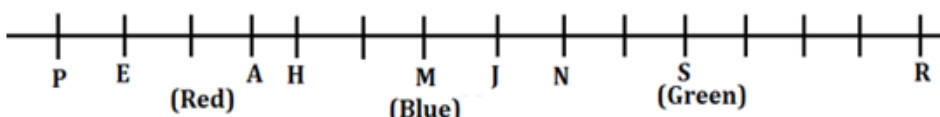

Explanation:

Clues:

R sits fourth to the right of S who is wearing a green shirt. The number of persons sitting between R and S is two more than the number of persons sitting between S and N.

Inference:

From these clues, we get two possible cases: -

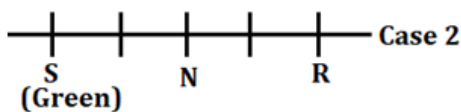
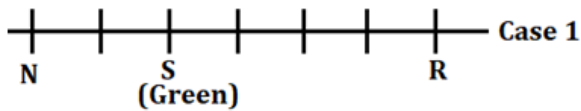

Clues:

The one who is wearing blue shirt sits second to the left of N. H sits 2nd to the left of the one who is wearing blue shirt.

Inference:

Case 2 will eliminate here because there is no place for the one who likes Blue.

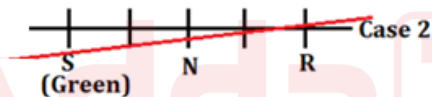
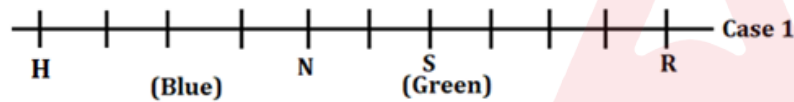

Clues:

J sits third to the right of H. Two persons sit between E and H. M and J are immediate neighbors. The one who is wearing red shirt sits 5th to the left of J.

Inference:

Thus, the one who is wearing red shirt is an immediate neighbour of E.

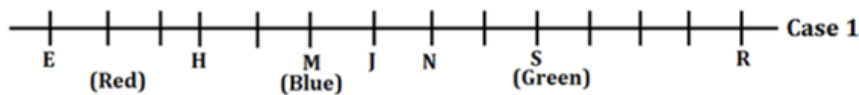

Clues:

The number of persons sitting between H and the one who is wearing red shirt is one less than the number of persons sitting between A and the one who is wearing blue shirt. P sits 3rd to the left of A.

Inference:

So, A will sit immediate left of H and thus the final arrangement: -

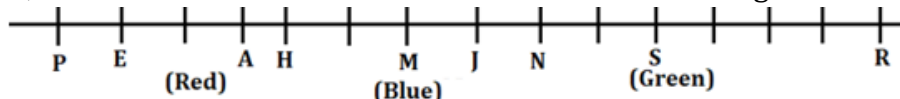

Minimum 15 persons are sitting in the row.

Q14. Who is sitting fourth to the right of H?

- (a). R
- (b). N
- (c). E
- (d). A
- (e). P

Ans.(b)

Sol. Final arrangement:

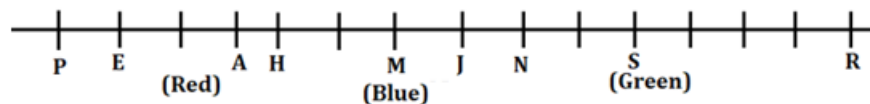

Explanation:

Clues:

R sits fourth to the right of S who is wearing a green shirt. The number of persons sitting between R and S is two more than the number of persons sitting between S and N.

Inference:

From these clues, we get two possible cases: -

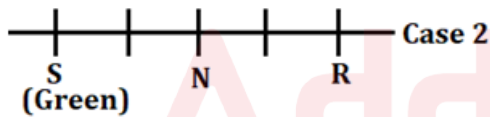
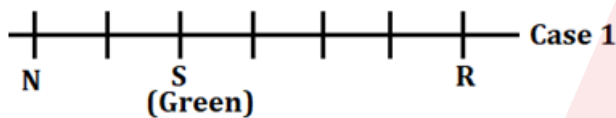

Clues:

The one who is wearing blue shirt sits second to the left of N. H sits 2nd to the left of the one who is wearing blue shirt.

Inference:

Case 2 will eliminate here because there is no place for the one who likes Blue.

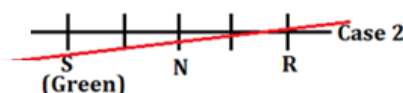
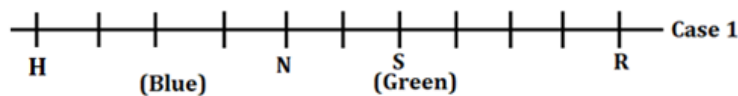

Clues:

J sits third to the right of H. Two persons sit between E and H. M and J are immediate neighbors. The one who is wearing red shirt sits 5th to the left of J.

Inference:

Thus, the one who is wearing red shirt is an immediate neighbour of E.

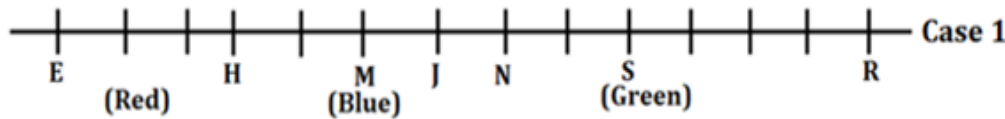

Clues:

The number of persons sitting between H and the one who is wearing red shirt is one less than the number of persons sitting between A and the one who is wearing blue shirt. P sits 3rd to the left of A.

Inference:

So, A will sit immediate left of H and thus the final arrangement: -

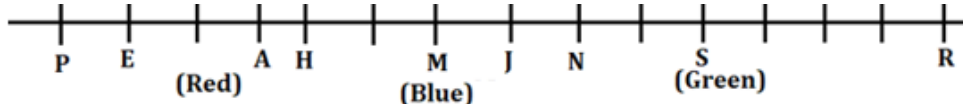

N sits fourth to the right of H.

Directions {15-16}: Study the following information carefully and answer the questions given below:

A certain number of persons sit in a row facing north. B sits sixth to the left of C. T sits fourth to the right of Q. U is an immediate neighbor of T. S sits third to the left of Q. There are three persons between T and R. V sits seventh from one of the ends. S sits fifth to the left of V. Four persons sit between U and M. C sits third to the right of M. As many persons sit between S and M as between R and W. Not more than 20 persons sit in this row. Only one person sits between B and I.

Q15. How many persons sit between the one who sits fourth to the right of I and C?

- (a). One
- (b). None
- (c). Three
- (d). Two
- (e). Four

Ans.(c)

Sol. Final Arrangement is here:

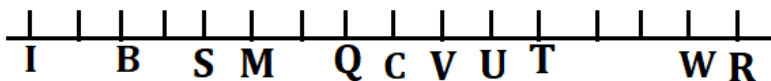

Clues: T sits fourth to the right of Q. U is an immediate neighbor of T. S sits third to the left of Q. There are three persons between T and R. V sits seventh from one of the ends. S sits fifth to the left of V. Four persons sit between U and M.

Inference: We have three possible cases here:

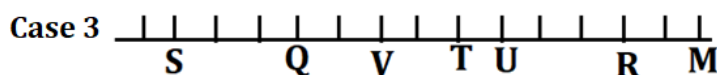
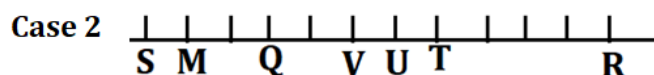
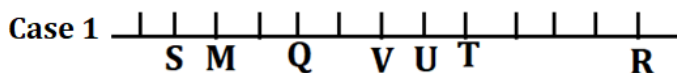

Clues: B sits sixth to the left of C. C sits third to the right of M. As many persons sit between S and M as between R and W. Not more than 20 persons sit in this row. Only one person sits between B and I.

Inference: Case 1 and Case 3 gets cancelled here:

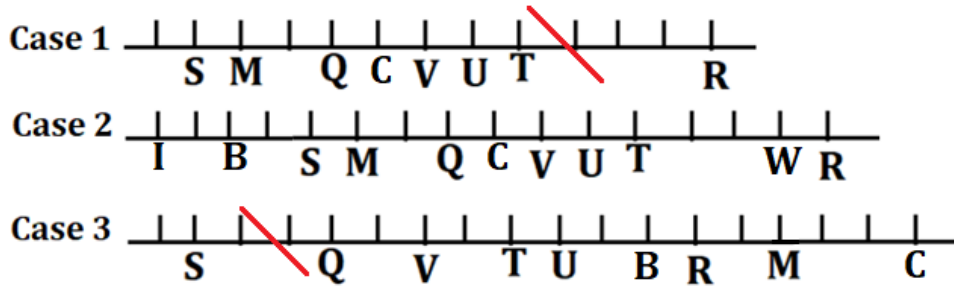

Inference: Final Arrangement is here:

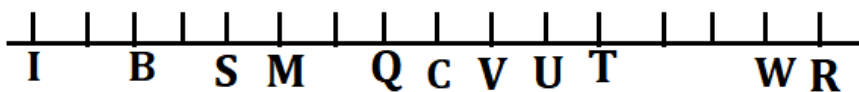

Three persons sit between the one who sits fourth to the right of I and C.

Q16. If T and W interchanged their positions then who among the following persons sits fourth to the left of T?

- (a). Q
- (b). U
- (c). V
- (d). C
- (e). None of these

Ans.(b)

Sol. Final Arrangement is here:

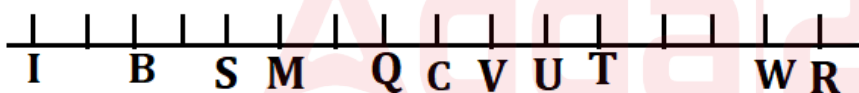

Clues: T sits fourth to the right of Q. U is an immediate neighbor of T. S sits third to the left of Q. There are three persons between T and R. V sits seventh from one of the ends. S sits fifth to the left of V. Four persons sit between U and M.

Inference: We have three possible cases here:

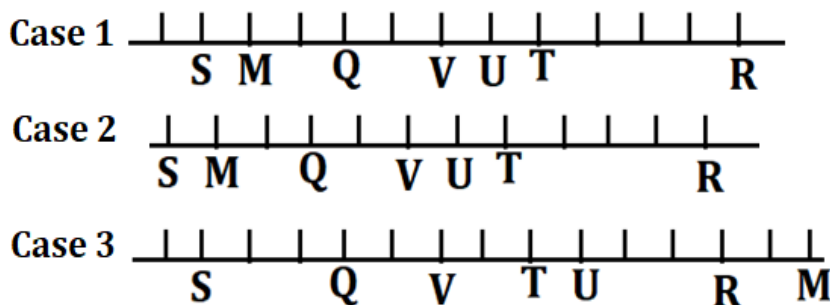

Clues: B sits sixth to the left of C. C sits third to the right of M. As many persons sit between S and M as between R and W. Not more than 20 persons sit in this row. Only one person sits between B and I.

Inference: Case 1 and Case 3 gets cancelled here:

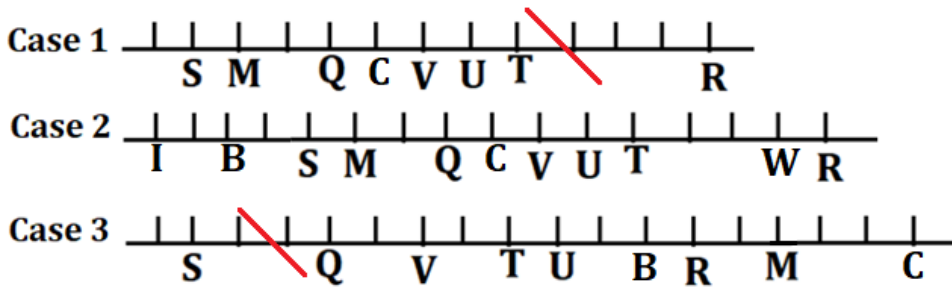

Inference: Final Arrangement is here:

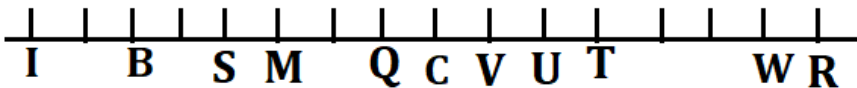

U sits fourth to the left of T, after interchanging the positions.

Directions {17-20}: Study the following information carefully and answer the given questions.

Six persons—S, T, U, V, W and X—sit on a triangular-shaped table, but not necessarily in the same order. Three persons sit at the middle of the sides of the table and three persons sit at the corners of the table. All of them face inside. Each one of them likes a different fruit.

T sits immediately to the right of the one who likes Orange. Two persons sit between T and W who sits fourth to the left of the one who likes Banana. X sits fourth to the right of the one who like Banana and is an immediate neighbour of the one who like Cherry. The one who likes Cherry sits second to right of the one who likes Mango. V sits immediately to the left of the one who likes Mango. Only one person sits between S and U who sits immediate left of the one who likes Pineapple. S doesn't sit on the middle of the sides of table. One of them likes Apple.

Q17. Who among the following persons sits fourth to the right of the person who likes Mango?

- (a). The person who sits opposite to the one who likes Cherry.
- (b). The person sits immediately to the left of the one who likes Orange.
- (c). The one who likes Apple
- (d). The person who sits immediately to the right of the person who likes Banana.
- (e). None of these.

Ans.(c)

Sol. Final arrangement -

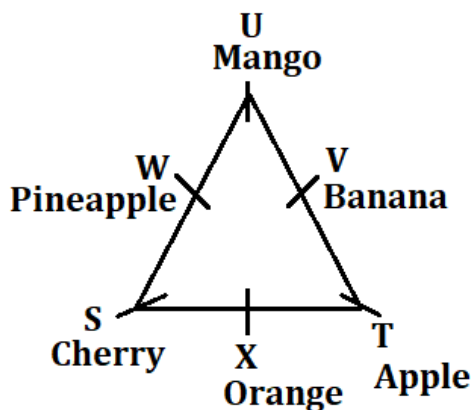

Clues- T sits immediately to the right of the one who likes Orange. Two persons sit between T and W who sits fourth to the left of the one who likes Banana.

Inference- Here we have 2 possible cases.

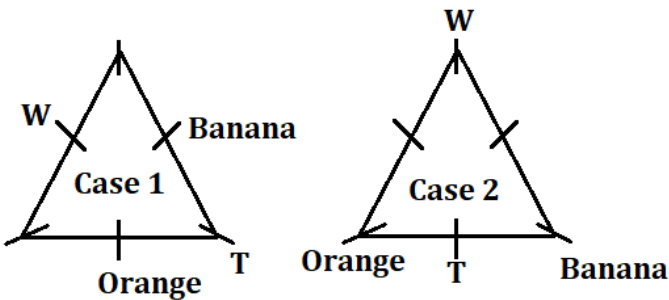
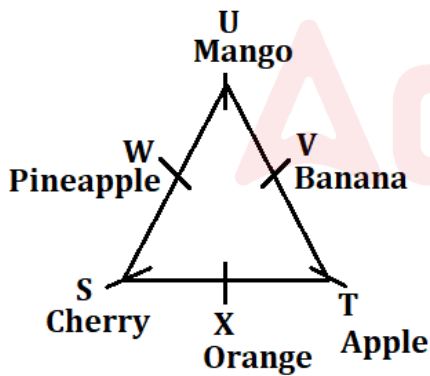
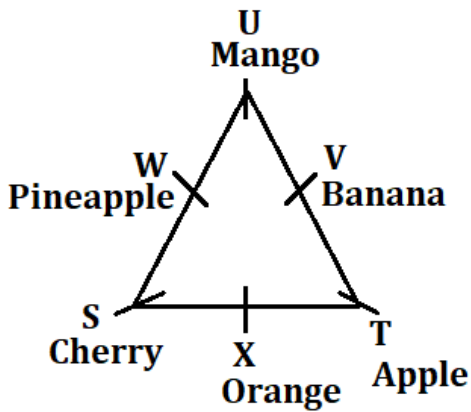
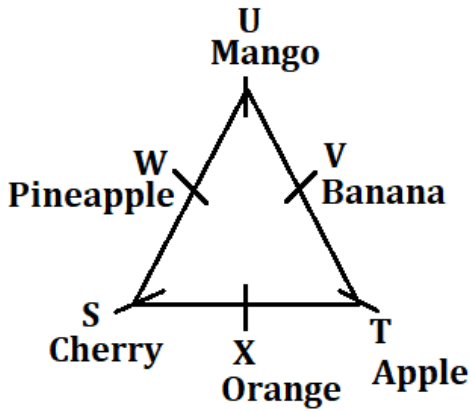

Clues- X sits fourth to the right of the one who like Banana and is an immediate neighbour of the one who like Cherry. The one who likes Cherry sits second to right of the one who likes Mango.

Inference- Here we get two places for Mango and Cherry.

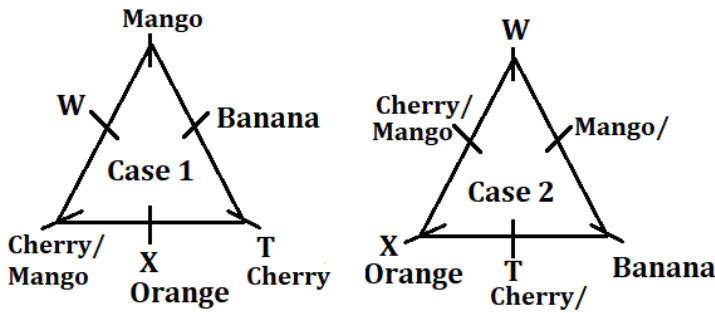

Clues- V sits immediately to the left of the one who likes Mango. Only one person sits between S and U who sits immediate left of the one who likes Pineapple. S doesn't sit on the middle of the sides of table. One of them likes Apple.

Inference- Only place for Apple is left in Case 1 and Case 2 gets cancelled here:

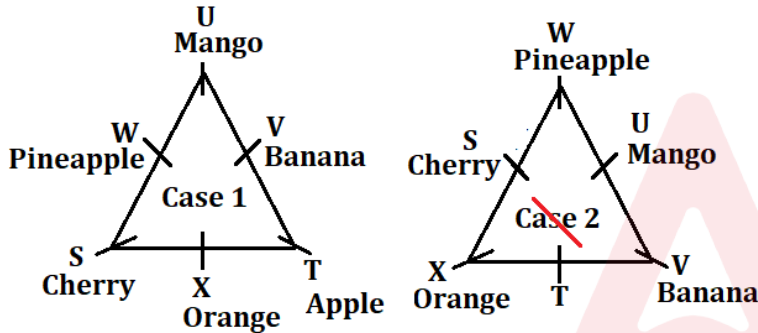

Inference- Final Arrangement is here:

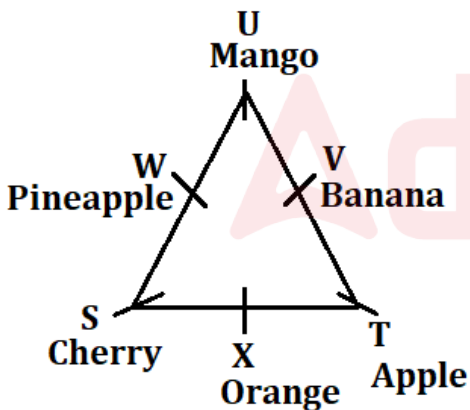

The one who likes Apple i.e. T sits fourth to the right of the person who likes Mango.

Q18. Which of the following statements is/are false?

- I. X sit at one of the corners.
 - II. S likes Cherry.
 - III. W doesn't like Pineapple.
- (a). Only I
 (b). Only II
 (c). Both II and III
 (d). Both I and III
 (e). All I, II, and III.

Ans.(d)

Sol. Final arrangement -

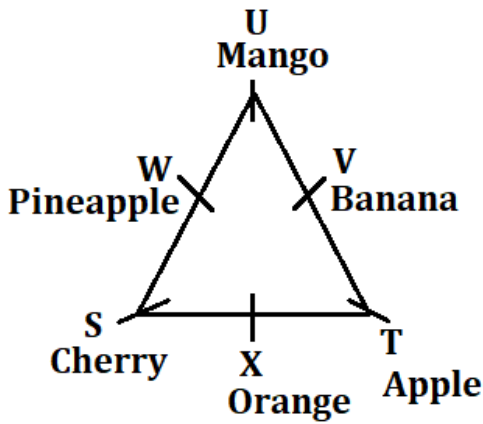

Clues- T sits immediately to the right of the one who likes Orange. Two persons sit between T and W who sits fourth to the left of the one who likes Banana.

Inference- Here we have 2 possible cases.

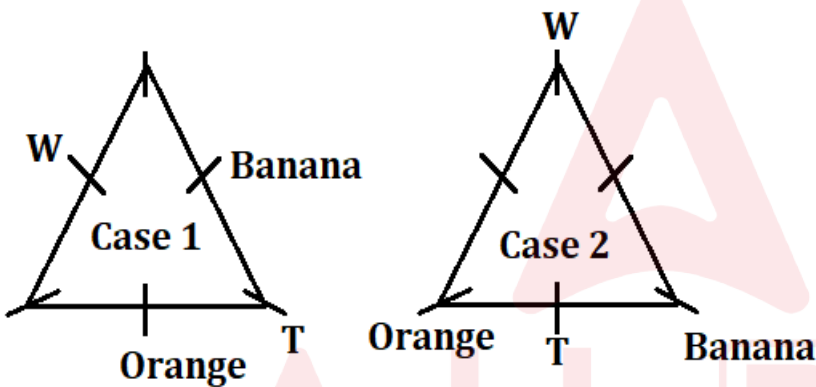

Clues- X sits fourth to the right of the one who like Banana and is an immediate neighbour of the one who like Cherry. The one who likes Cherry sits second to right of the one who likes Mango.

Inference- Here we get two places for Mango and Cherry.

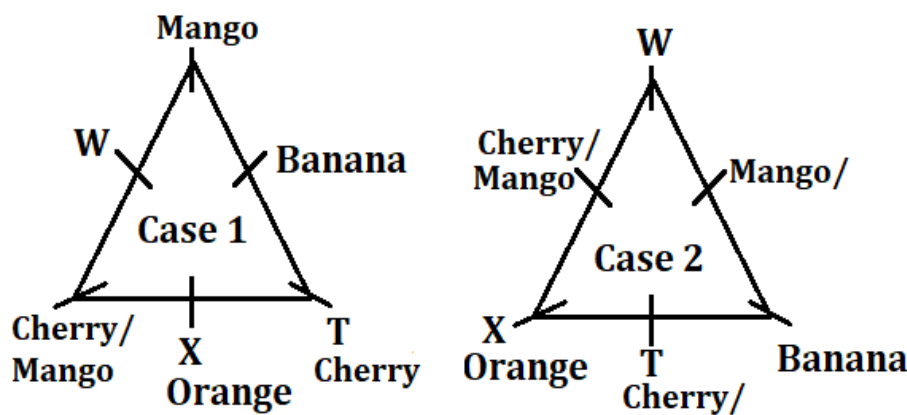

Clues- V sits immediately to the left of the one who likes Mango. Only one person sits between S and U who sits immediate left of the one who likes Pineapple. S doesn't sit on the middle of the sides of table. One of them likes Apple.

Inference- Only place for Apple is left in Case 1 and Case 2 gets cancelled here:

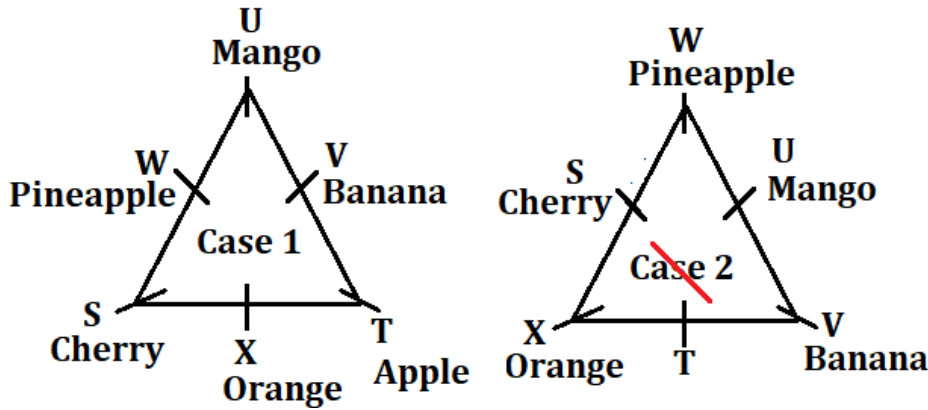

Inference- Final Arrangement is here:

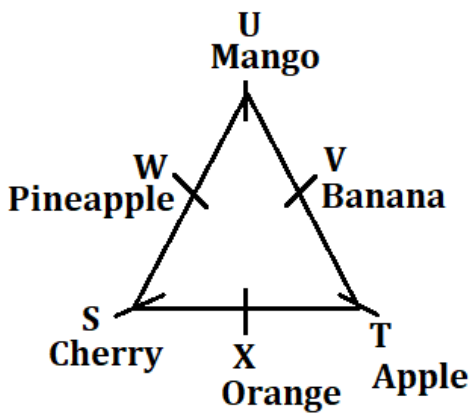

Both I and III

Q19. If U and W interchanged its position then what is the position of W with respect to X?

- (a). Immediate right
- (b). Second to the left
- (c). Second to the right
- (d). Third to the left
- (e). Immediate left.

Ans.(d)

Sol. Final arrangement -

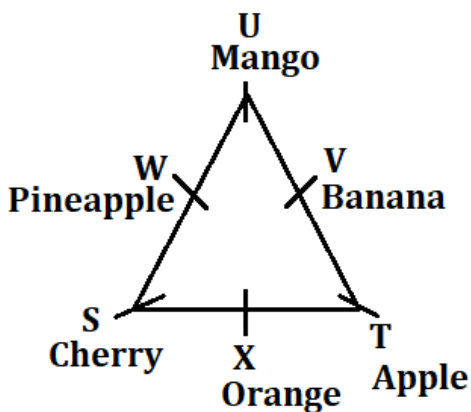

Clues- T sits immediately to the right of the one who likes Orange. Two persons sit between T and W who sits fourth to the left of the one who likes Banana.

Inference- Here we have 2 possible cases.

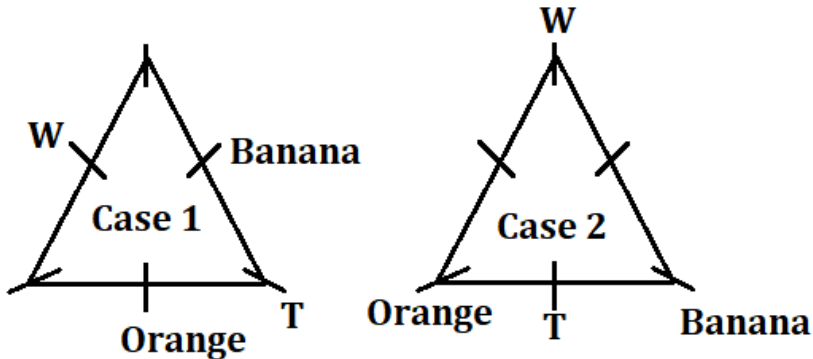

Clues- X sits fourth to the right of the one who like Banana and is an immediate neighbour of the one who like Cherry. The one who likes Cherry sits second to right of the one who likes Mango.

Inference- Here we get two places for Mango and Cherry.

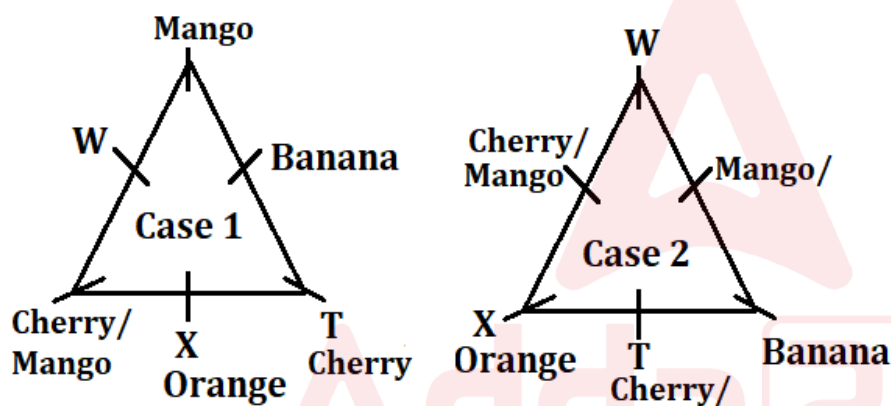

Clues- V sits immediately to the left of the one who likes Mango. Only one person sits between S and U who sits immediate left of the one who likes Pineapple. S doesn't sit on the middle of the sides of table. One of them likes Apple.

Inference- Only place for Apple is left in Case 1 and Case 2 gets cancelled here:

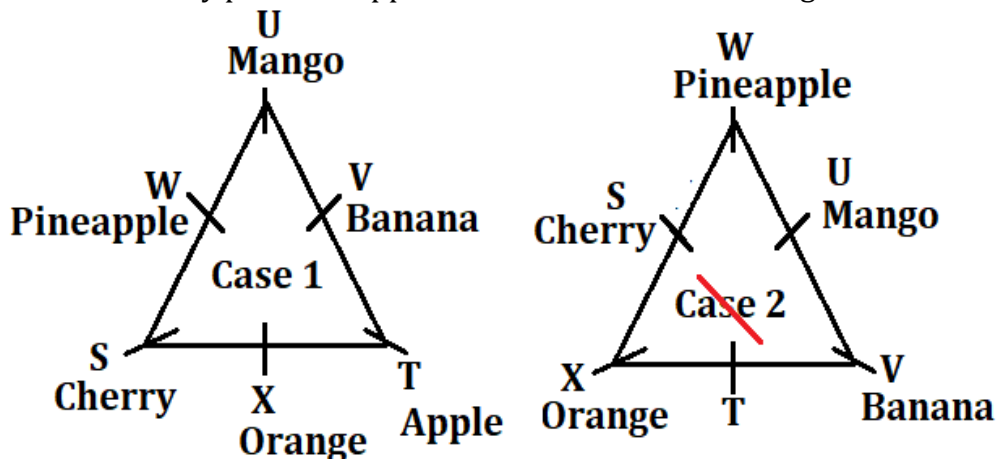

Inference- Final Arrangement is here:

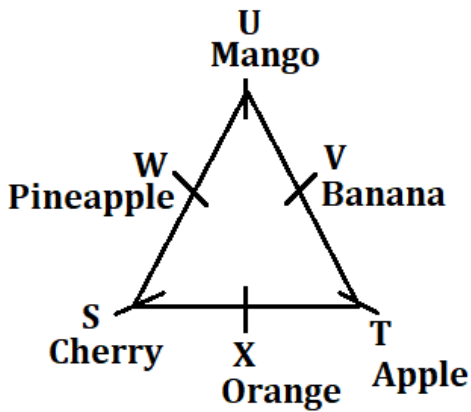

The position of W with respect to X is third to the left, after interchanging the positions.

Q20. How many persons sit between the ones who like Pineapple and Apple when counted from the left of the one who likes Apple?

- (a). One
- (b). Two
- (c). Three
- (d). None
- (e). Four

Ans.(b)

Sol. Final arrangement -

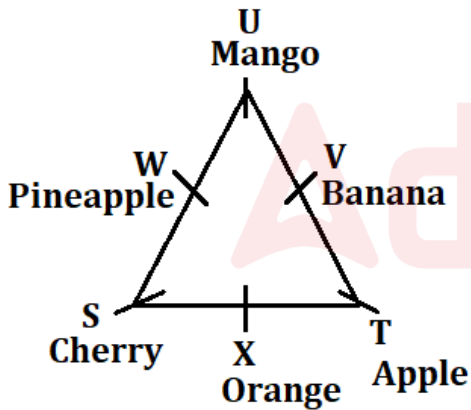

Clues- T sits immediately to the right of the one who likes Orange. Two persons sit between T and W who sits fourth to the left of the one who likes Banana.

Inference- Here we have 2 possible cases.

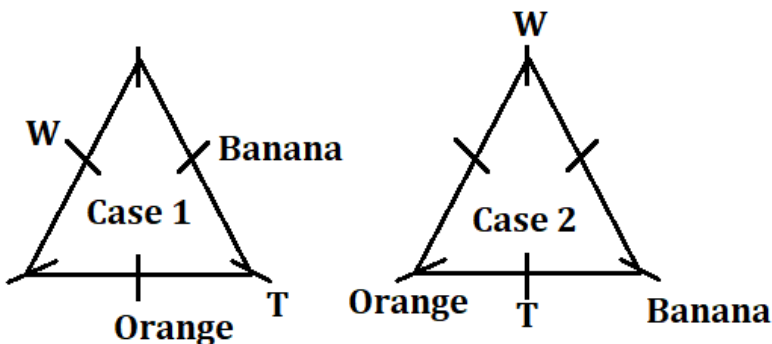

Clues- X sits fourth to the right of the one who like Banana and is an immediate neighbour of the one who like Cherry. The one who likes Cherry sits second to right of the one who likes Mango.

Inference- Here we get two places for Mango and Cherry.

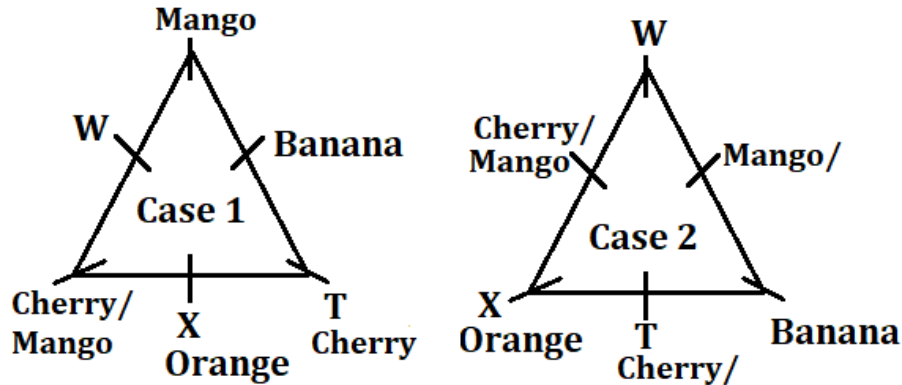

Clues- V sits immediately to the left of the one who likes Mango. Only one person sits between S and U who sits immediate left of the one who likes Pineapple. S doesn't sit on the middle of the sides of table. One of them likes Apple.

Inference- Only place for Apple is left in Case 1 and Case 2 gets cancelled here:

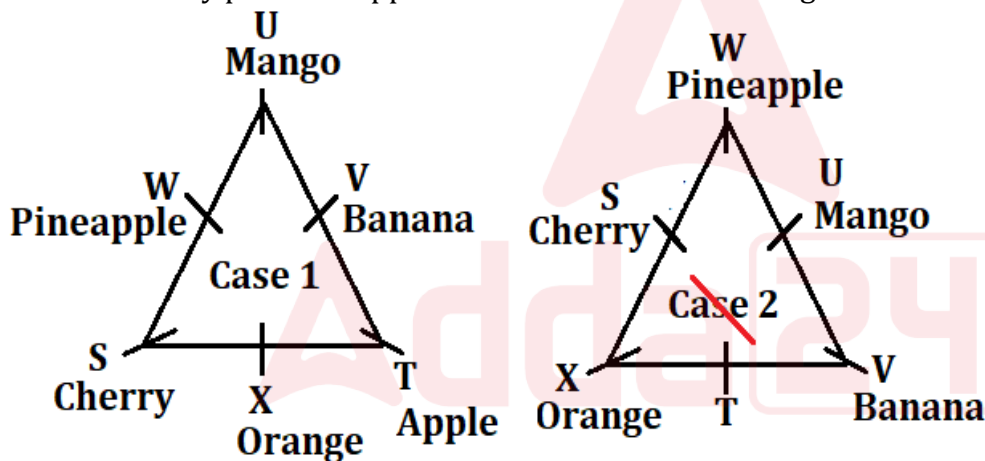

Inference- Final Arrangement is here:

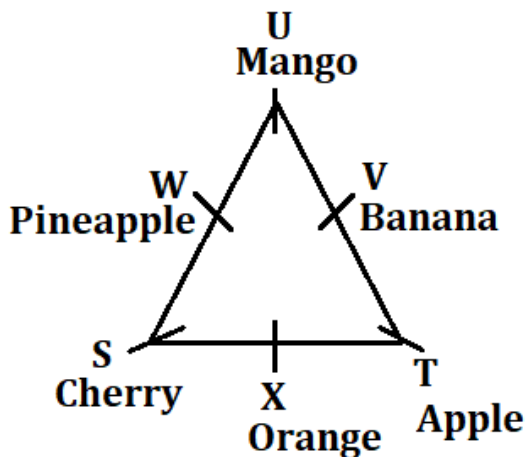

Two persons sit between the ones who likes Pineapple and Apple when counted from the left of the one who likes Apple.

Directions {21-25}: Study the following information to answer the given questions:

Eight persons P, Q, R, S, T, U, V, and W are sitting around a rectangular table such that four of them sits at the corner and face inside the center and four of them sits in the middle and face outside the center of the table. They all have different heights viz. 150cm, 152cm, 169cm, 172cm, 175cm, 160cm, 155cm, and 180cm. All the data was not necessarily in the same order.

The one whose height is 169cm sits third to the right of W. Two persons sit between the one whose height is 169cm and T. The one who is tallest sit opposite to the one who is shortest. Q doesn't sit at any corner of the table but he sits second to the left of U, whose height is 155cm. The one whose height is 175cm is an immediate neighbor of T but he doesn't face the one whose height is 169cm. W is shorter than P. R and S are immediate neighbors of Q. R height is more than 170cm. V sits second to the right of P, who is an immediate neighbor of the tallest persons. P sits at one of the corner side of the table.

Q21. Who among the following is the shortest person?

- (a). T
- (b). V
- (c). Q
- (d). W
- (e). None of these

Ans.(c)

Sol. From the given statements, the one whose height is 169cm sits third to the right of W. Two persons sit between the one whose height is 169cm and T. We have two possible cases case1 and case 2.

Q doesn't sit at any corner of the table but he sits second to the left of U, whose height is 155cm. The one whose height is 175cm is an immediate neighbor of T but he doesn't face the one whose height is 169cm. R and S are immediate neighbors of Q. Here we get 2 possible cases i.e. Case 1 and Case 2.

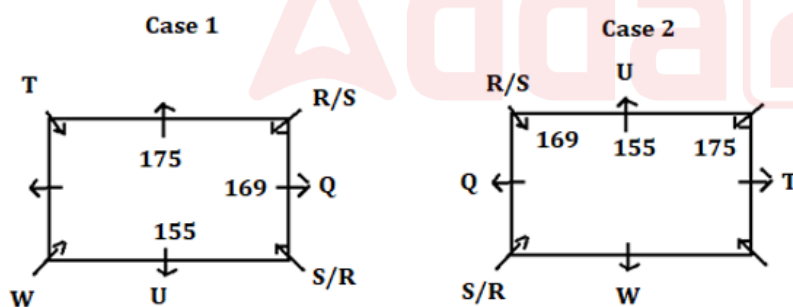

W is shorter than P. R height is more than 170cm. V sits second to the right of P, who is an immediate neighbor of the tallest persons. The one who is tallest sits opposite to the one who is shortest. P sits at one of the corner side of the table. Here Case 1 is ruled out now. So, the final arrangement is-

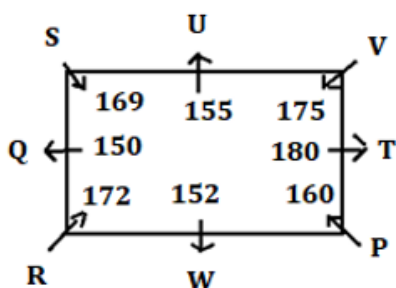

Q22. Who among the following sits opposite to the one whose height is 152cm?

- (a). U
- (b). R
- (c). T
- (d). Q
- (e). None of these

Ans.(a)

Sol. From the given statements, the one whose height is 169cm sits third to the right of W. Two persons sit between the one whose height is 169cm and T. We have two possible cases case1 and case 2. Q doesn't sit at any corner of the table but he sits second to the left of U, whose height is 155cm. The one whose height is 175cm is an immediate neighbor of T but he doesn't face the one whose height is 169cm. R and S are immediate neighbors of Q. Here we get 2 possible cases i.e. Case 1 and Case 2.

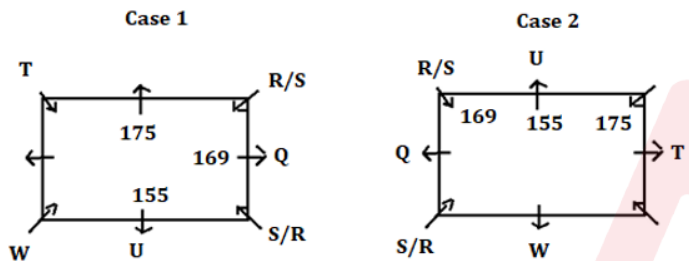

W is shorter than P. R height is more than 170cm. V sits second to the right of P, who is an immediate neighbor of the tallest persons. The one who is tallest sits opposite to the one who is shortest. P sits at one of the corner side of the table. Here Case 1 is ruled out now. So, the final arrangement is-

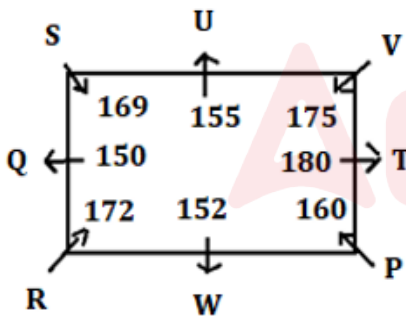

Q23. What is the height of the person who sits third to the right of T?

- (a). 175cm
- (b). 155cm
- (c). 172cm
- (d). 180cm
- (e). None of these

Ans.(c)

Sol. From the given statements, the one whose height is 169cm sits third to the right of W. Two persons sit between the one whose height is 169cm and T. We have two possible cases case1 and case 2.



Q doesn't sit at any corner of the table but he sits second to the left of U, whose height is 155cm. The one whose height is 175cm is an immediate neighbor of T but he doesn't face the one whose height is 169cm. R and S are immediate neighbors of Q. Here we get 2 possible cases i.e. Case 1 and Case 2.

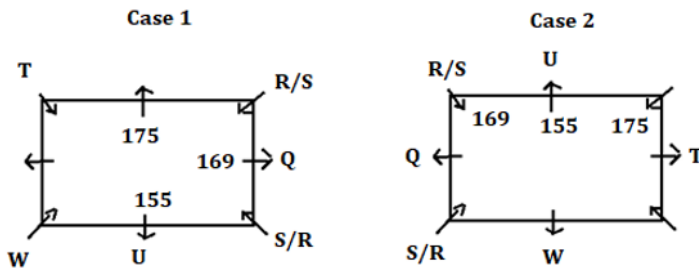

W is shorter than P. R height is more than 170cm. V sits second to the right of P, who is an immediate neighbor of the tallest persons. The one who is tallest sits opposite to the one who is shortest. P sits at one of the corner side of the table. Here Case 1 is ruled out now. So, the final arrangement is-

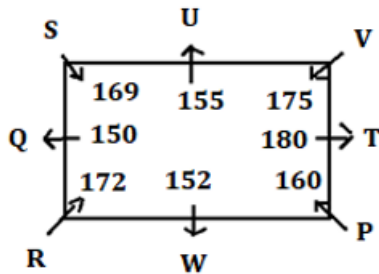

Q24. How many persons sit between the one whose height is 180cm and S, when counted from the right of S?

- (a). One
- (b). Two
- (c). Three
- (d). Four
- (e). None of these

Ans.(d)

Sol. From the given statements, the one whose height is 169cm sits third to the right of W. Two persons sit between the one whose height is 169cm and T. We have two possible cases case1 and case 2.

Q doesn't sit at any corner of the table but he sits second to the left of U, whose height is 155cm. The one whose height is 175cm is an immediate neighbor of T but he doesn't face the one whose height is 169cm. R and S are immediate neighbors of Q. Here we get 2 possible cases i.e. Case 1 and Case 2.

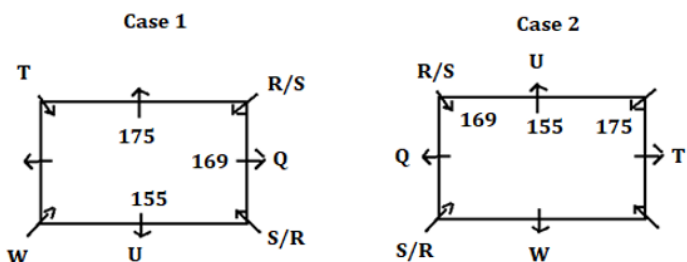

W is shorter than P. R height is more than 170cm. V sits second to the right of P, who is an immediate neighbor of the tallest persons. The one who is tallest sits opposite to the one who is shortest. P sits at one of the corner side of the table. Here Case 1 is ruled out now. So, the final arrangement is-

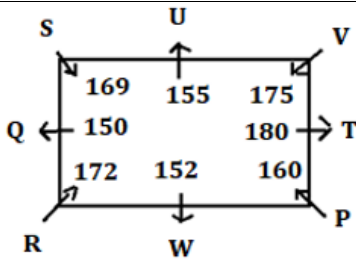

Q25. Four of the following five are alike in a certain way based on a group, which among the following does not belong to that group?

- (a). U - W
- (b). R - V
- (c). S - P
- (d). Q - V
- (e). T - Q

Ans.(d)

Sol. From the given statements, the one whose height is 169cm sits third to the right of W. Two persons sit between the one whose height is 169cm and T. We have two possible cases case1 and case 2.

Q doesn't sit at any corner of the table but he sits second to the left of U, whose height is 155cm. The one whose height is 175cm is an immediate neighbor of T but he doesn't face the one whose height is 169cm. R and S are immediate neighbors of Q. Here we get 2 possible cases i.e. Case 1 and Case 2.

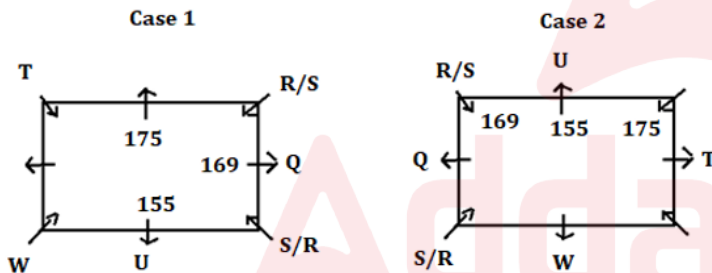

W is shorter than P. R height is more than 170cm. V sits second to the right of P, who is an immediate neighbor of the tallest persons. The one who is tallest sits opposite to the one who is shortest. P sits at one of the corner side of the table. Here Case 1 is ruled out now. So, the final arrangement is-

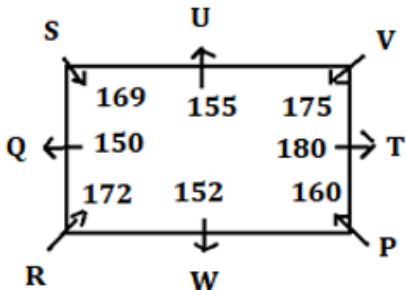

Directions {26-30}: Study the following information carefully and answer the below questions.

Eight persons- A, B, C, D, E, F, G, and H are sitting around circular table facing towards the centre of the table but not necessarily in the same order. They all like different fruits – Mango, Cherry, Apple, Orange, Plum, Kiwi, Banana and Grapes but not necessarily in the same order.

Two persons sit between A and the one who likes apple. The one who likes apple sits opposite to the one who sits second to the left of G. C sits opposite to the one who likes cherry. Neither A nor G likes cherry. A doesn't sit next to the one who likes cherry. F sits immediate right of the one who likes banana and sits next to A. A doesn't like banana. F sits third to the right of the one who likes orange. The one who likes mango sits next to G. B sits to the immediate right of D. H likes kiwi but doesn't sit adjacent to B. The one who likes plum doesn't sit opposite to B.

Q26. Who among the following likes plum?

- (a). The one who sits opposite to E
- (b). C
- (c). The one who sits second to the left of B
- (d). A
- (e). None of these

Ans.(c)

Sol. Two persons sit between A and the one who likes apple. From the given statement we have two possible cases i.e. case 1 and case 2. The one who likes apple sits opposite to the one who sits second to the left of G. C sits opposite to the one who likes cherry. Neither A nor G likes cherry. A doesn't sit next to the one who likes cherry.

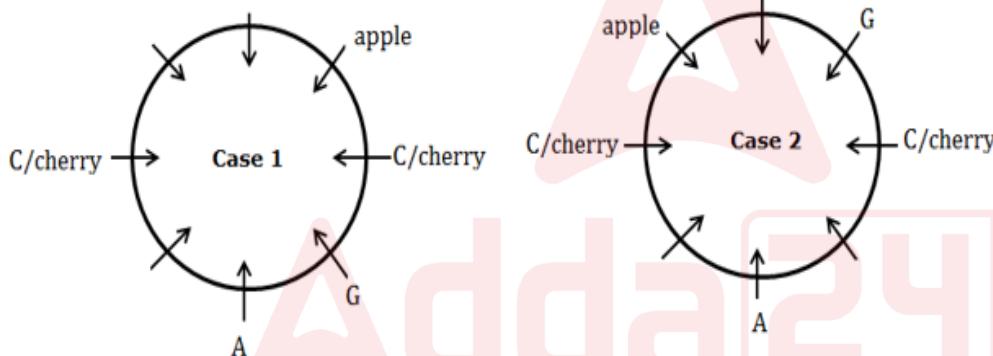

F sits immediate right of the one who likes banana and sits next to A. A doesn't like banana. F sits third to the right of the one who likes orange. The one who likes mango sits next to G. So, case 2 gets eliminated here. B sits to the immediate right of D. H likes kiwi but doesn't sit adjacent to B. The one who likes plum doesn't sit opposite to B.

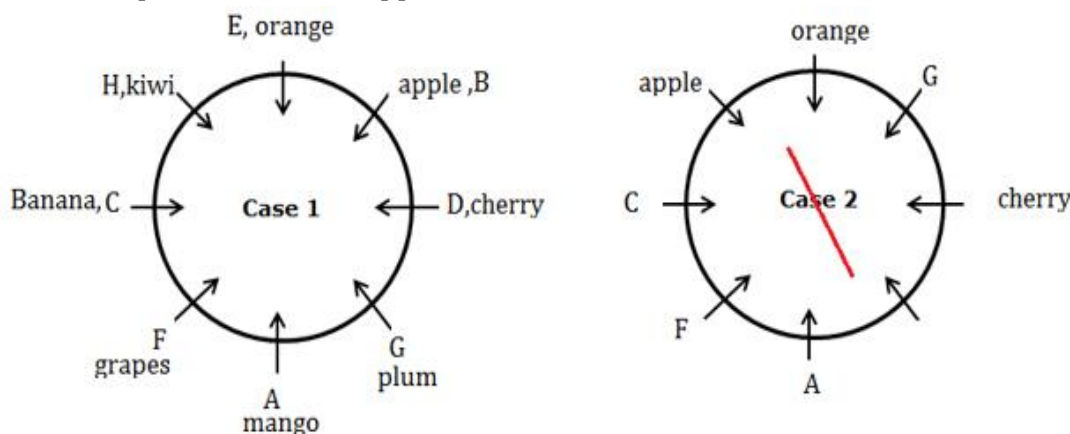

The finale arrangement is:

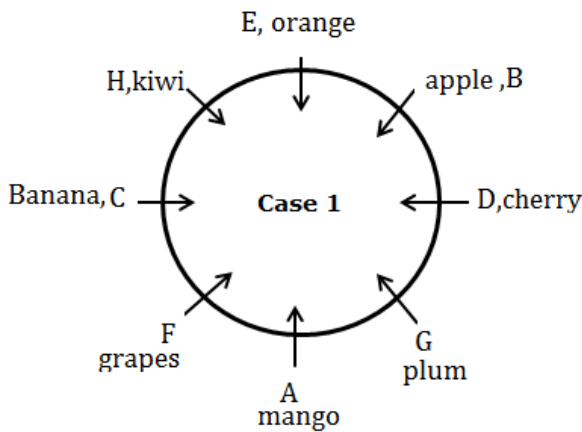

G likes plum.

Q27. How many persons sit between E and the one who likes Grapes when counted to the left of E?

- (a). One
- (b). Two
- (c). Three
- (d). More than three
- (e). None

Ans.(d)

Sol. Two persons sit between A and the one who likes apple .From the given statement we have two possible cases i.e. case 1 and case 2. The one who likes apple sits opposite to the one who sits second to the left of G. C sits opposite to the one who likes cherry. Neither A nor G likes cherry. A doesn't sit next to the one who likes cherry.

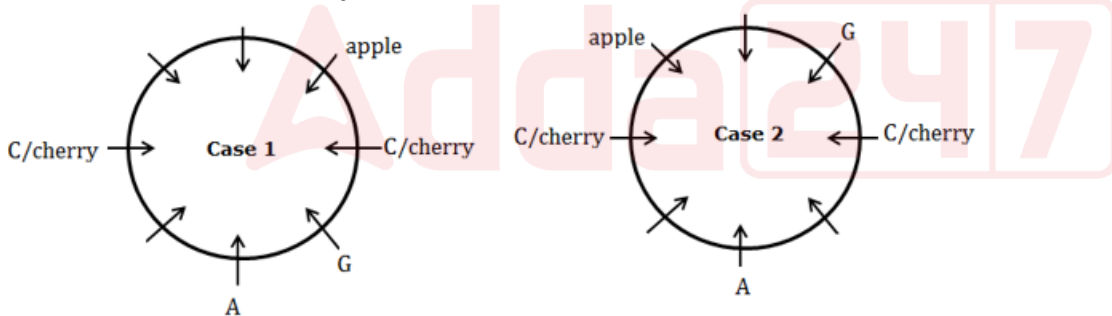

F sits immediate right of the one who likes banana and sits next to A. A doesn't like banana. F sits third to the right of the one who likes orange. The one who likes mango sits next to G. So, case 2 gets eliminated here. B sits to the immediate right of D. H likes kiwi but doesn't sit adjacent to B. The one who likes plum doesn't sit opposite to B.

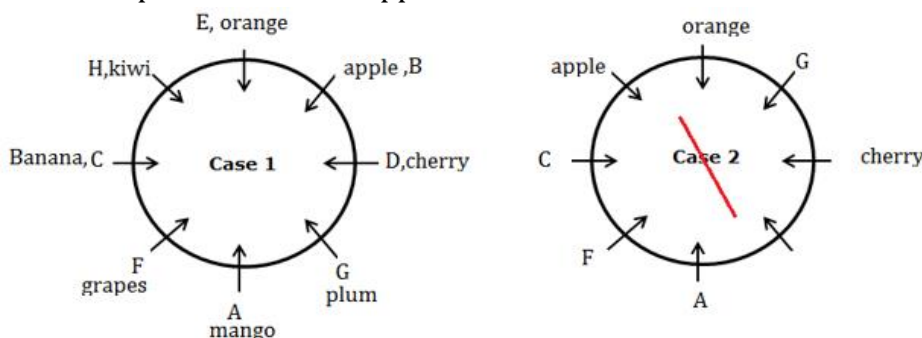

The finale arrangement is:

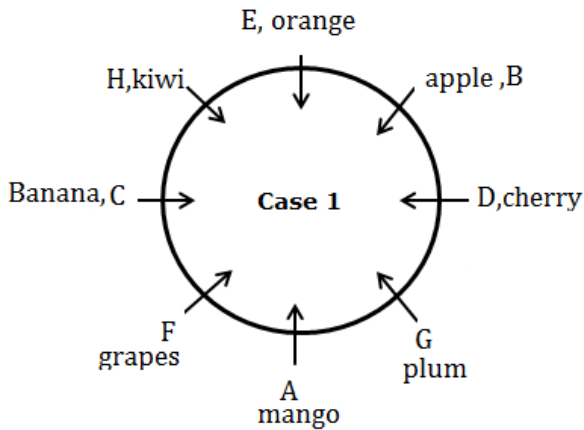

4 persons sit between E and F when counted to the left of E.

Q28. Four of the five among the following are similar in such a way to form a group, which one of the following doesn't belong to the group?

- (a). E-A
- (b). B-Grapes
- (c). H- G
- (d). B-Apple
- (e). Kiwi-Plum

Ans.(d)

Sol. Two persons sit between A and the one who likes apple. From the given statement we have two possible cases i.e. case 1 and case 2. The one who likes apple sits opposite to the one who sits second to the left of G. C sits opposite to the one who likes cherry. Neither A nor G likes cherry. A doesn't sit next to the one who likes cherry.

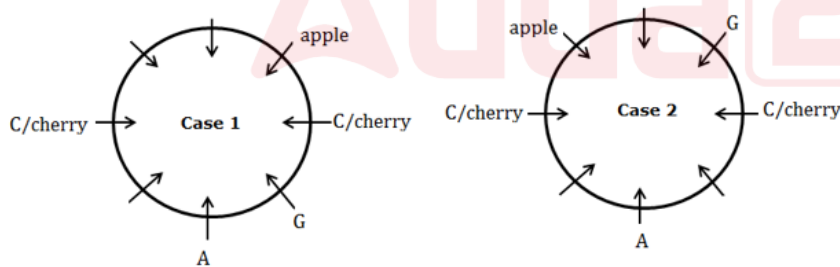

F sits immediate right of the one who likes banana and sits next to A. A doesn't like banana. F sits third to the right of the one who likes orange. The one who likes mango sits next to G. So, case 2 gets eliminated here. B sits to the immediate right of D. H likes kiwi but doesn't sit adjacent to B. The one who likes plum doesn't sit opposite to B.

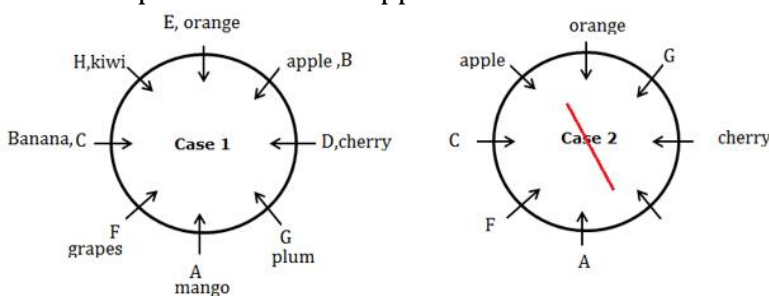

The finale arrangement is:

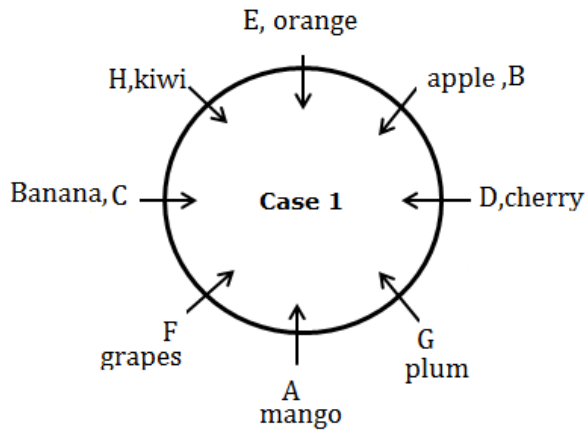

All sits opposite to each other except in option d.

Q29. Which of the following statement is not true?

- (a). E sits opposite to A
- (b). G likes plum
- (c). Three persons sit between B and F
- (d). D doesn't like banana
- (e). All the statements are true

Ans.(e)

Sol. Two persons sit between A and the one who likes apple .From the given statement we have two possible cases i.e. case 1 and case 2. The one who likes apple sits opposite to the one who sits second to the left of G. C sits opposite to the one who likes cherry. Neither A nor G likes cherry. A doesn't sit next to the one who likes cherry.

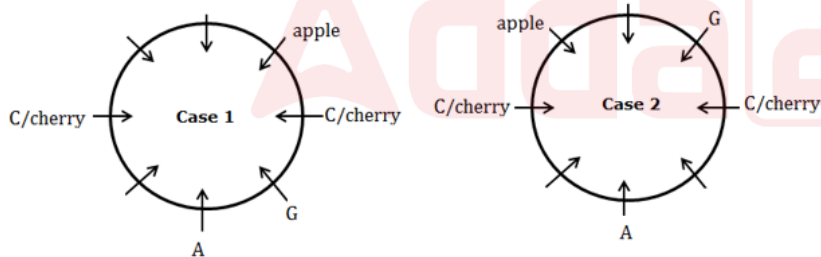

F sits immediate right of the one who likes banana and sits next to A. A doesn't like banana. F sits third to the right of the one who likes orange. The one who likes mango sits next to G. So, case 2 gets eliminated here. B sits to the immediate right of D. H likes kiwi but doesn't sit adjacent to B. The one who likes plum doesn't sit opposite to B.

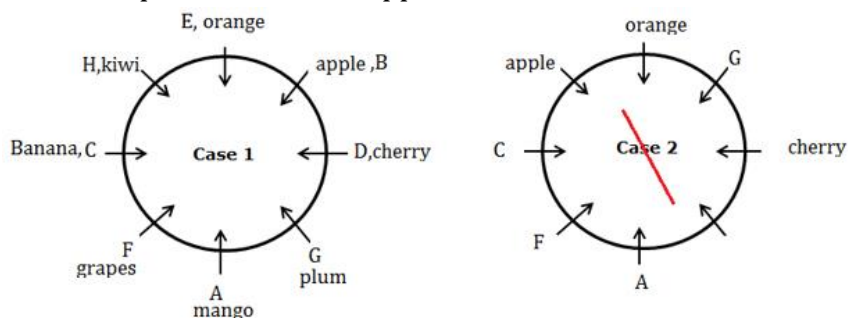

The finale arrangement is:

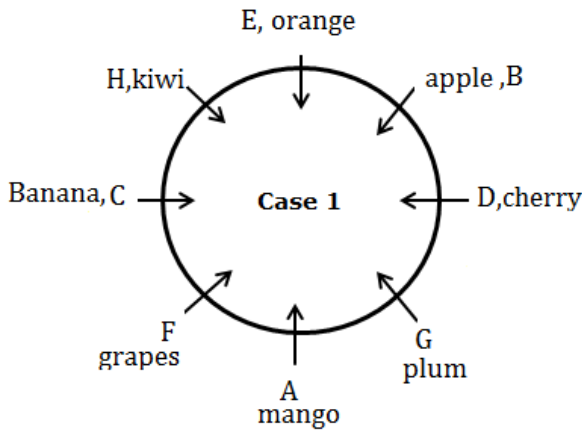

Q30. If E is related to the one who likes cherry, in the similar way B is related to G then who among the following is related to H?

- (a). The one who likes grapes
- (b). G
- (c). The one who sits immediate left to C
- (d). D
- (e). None of these

Ans.(a)

Sol. Two persons sit between A and the one who likes apple .From the given statement we have two possible cases i.e. case 1 and case 2. The one who likes apple sits opposite to the one who sits second to the left of G. C sits opposite to the one who likes cherry. Neither A nor G likes cherry. A doesn't sit next to the one who likes cherry.

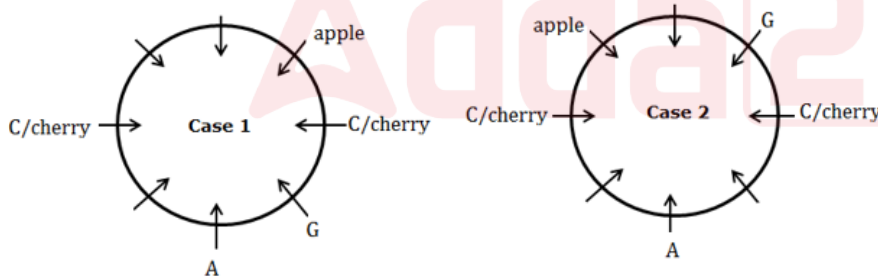

F sits immediate right of the one who likes banana and sits next to A. A doesn't like banana. F sits third to the right of the one who likes orange. The one who likes mango sits next to G. So, case 2 gets eliminated here. B sits to the immediate right of D. H likes kiwi but doesn't sit adjacent to B. The one who likes plum doesn't sit opposite to B.

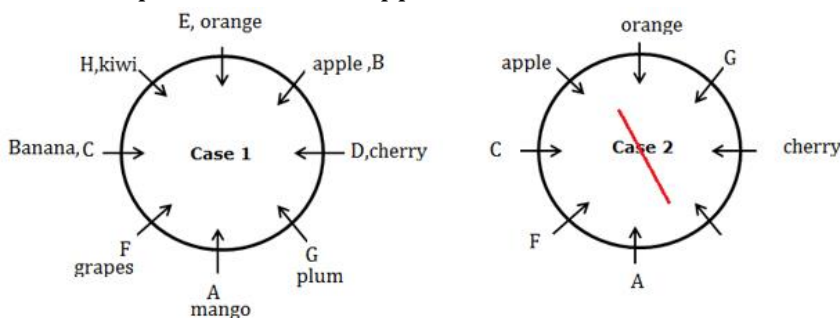

The finale arrangement is:

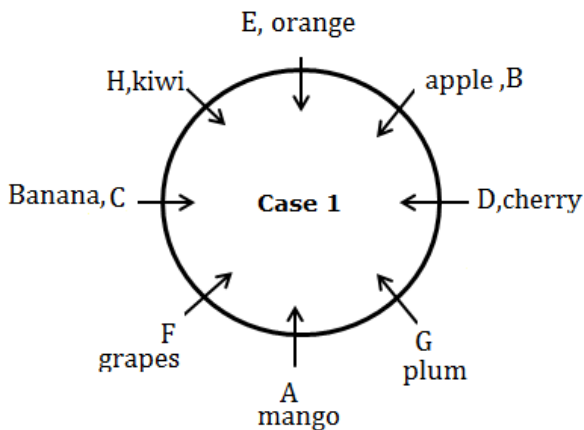

Directions {31-35}: Study the given information to answer the questions below:

Seven persons D, C, G, H, T, X and Z sit in a linear row (but not necessarily in the same order) and all face north. They also like different colours.

T is the only neighbour of the one who likes white. Three persons sit between T and the one who likes green. D and the one who likes green are immediate neighbours to each other. Two persons sit between Z and D who likes silver. H is not the immediate neighbour of Z. H sits immediate left to the one who likes pink. X sits adjacent to the one who likes orange. Z does not like orange. G likes grey but not sit to the right of C. One of the persons like yellow colour.

Q31. Who among the following likes yellow?

- (a). Z
- (b). H
- (c). X
- (d). C
- (e). None of these

Ans.(a)

Sol. From the given statement, T is the only neighbour of the one who likes white. There are two possible cases. Three persons sit between T and the one who likes green. D and the one who likes green are immediate neighbours to each other. Two persons sit between Z and D who likes silver.

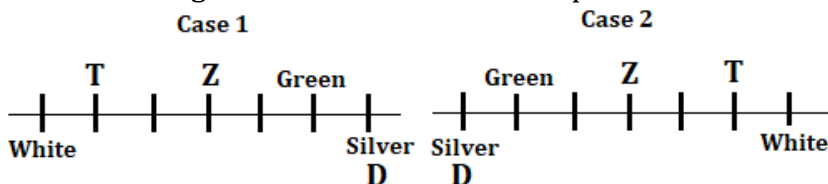

H is not the immediate neighbour of Z. H sits immediate left to the one who likes pink. X sits adjacent to the one who likes orange. Z does not like orange. G likes grey but not sit to the right of C. Case 2 will eliminate here. One of the persons like yellow colour. So, the final arrangement is:

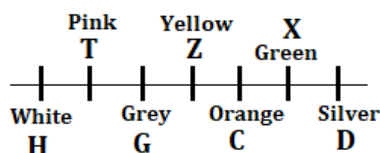

Q32. Who among the following sits fourth to the left of X?

- (a). The one who likes grey
- (b). The one who likes pink
- (c). H
- (d). D
- (e). None of these

Ans.(b)

Sol. From the given statement, T is the only neighbour of the one who likes white. There are two possible cases. Three persons sit between T and the one who likes green. D and the one who likes green are immediate neighbours to each other. Two persons sit between Z and D who likes silver.

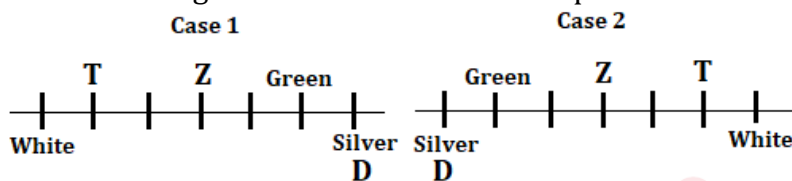

H is not the immediate neighbour of Z. H sits immediate left to the one who likes pink. X sits adjacent to the one who likes orange. Z does not like orange. G likes grey but not sit to the right of C. Case 2 will eliminate here. One of the persons like yellow colour. So, the final arrangement is:

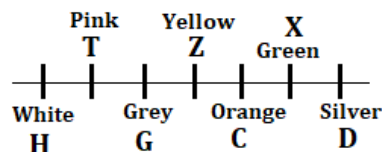

Q33. How many persons sit between D and the one who likes grey?

- (a). One
- (b). Two
- (c). Three
- (d). Four
- (e). None of these

Ans.(c)

Sol. From the given statement, T is the only neighbour of the one who likes white. There are two possible cases. Three persons sit between T and the one who likes green. D and the one who likes green are immediate neighbours to each other. Two persons sit between Z and D who likes silver.

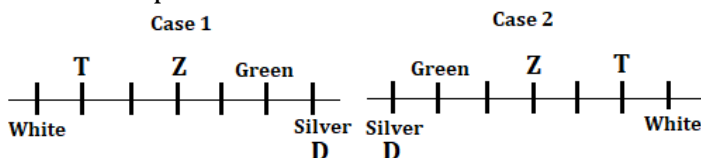

H is not the immediate neighbour of Z. H sits immediate left to the one who likes pink. X sits adjacent to the one who likes orange. Z does not like orange. G likes grey but not sit to the right of C. Case 2 will eliminate here. One of the persons like yellow colour. So, the final arrangement is:



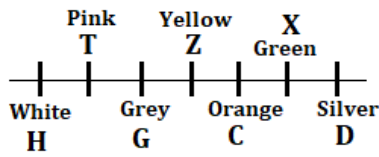

Q34. H likes which among the following colour?

- (a). Green
- (b). Orange
- (c). White
- (d). Yellow
- (e). Either (A) or (D)

Ans.(c)

Sol. From the given statement, T is the only neighbour of the one who likes white. There are two possible cases. Three persons sit between T and the one who likes green. D and the one who likes green are immediate neighbours to each other. Two persons sit between Z and D who likes silver.

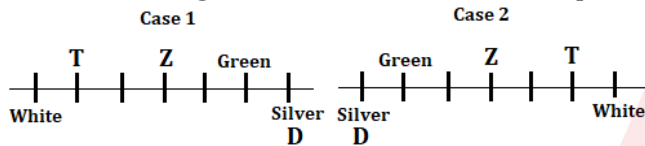

H is not the immediate neighbour of Z. H sits immediate left to the one who likes pink. X sits adjacent to the one who likes orange. Z does not like orange. G likes grey but not sit to the right of C. Case 2 will eliminate here. One of the persons like yellow colour. So, the final arrangement is:

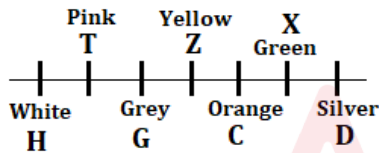

Q35. Which among the following pair of combination is incorrect?

- (a). T-pink
- (b). D-silver
- (c). Z-pink
- (d). C-orange
- (e). H-white

Ans.(c)

Sol. From the given statement, T is the only neighbour of the one who likes white. There are two possible cases. Three persons sit between T and the one who likes green. D and the one who likes green are immediate neighbours to each other. Two persons sit between Z and D who likes silver.

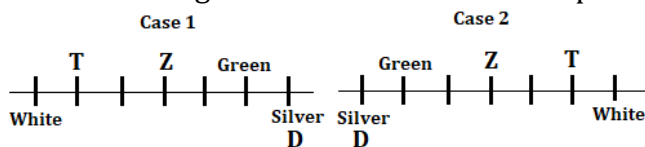

H is not the immediate neighbour of Z. H sits immediate left to the one who likes pink. X sits adjacent to the one who likes orange. Z does not like orange. G likes grey but not sit to the right of C. Case 2 will eliminate here. One of the persons like yellow colour. So, the final arrangement is:

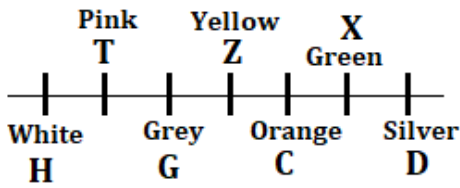

Directions {36-40}: Study the following information carefully and answer the questions given below:

A certain number of persons sit around a circular table and facing towards the centre. Some of them get pocket money of different amount in a multiple of 100 but no one gets more than 1000. Q sits 2nd to the left of B who gets 5 times of pocket money than F. F sits 3 places away from B. F does not sit near to Q who gets twice pocket money than D. D sits 3rd to the left of T who gets thrice pocket money than F. D and F are not an immediate neighbours. Q and T are immediate neighbours. D gets the pocket money $\frac{2}{3}$ than T. F gets neither 200 nor 300. Not more than one person sits between D and F when counted to the right of F. Sum of the pocket money of B's immediate neighbours is 1000.

Q36. What is the position of F with respect to T?

- (a). 5th to the right
- (b). 4th to the right
- (c). 3rd to the left
- (d). 2nd to the right
- (e). Immediate left

Ans.(b)

Sol. From the given statements, each of them gets different pocket money in a multiple of 100 but not more than 1000 which means not more than 10 persons sit around the table. Q sits 2nd to the left of B who gets 5 times of pocket money than F. Here we have 2 possible cases. F sits 3 places away from B. F does not sit near to Q.

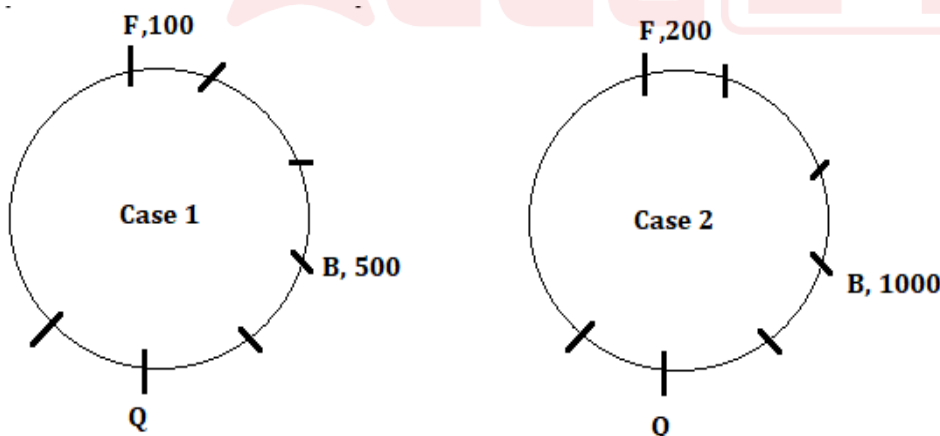

D sits 3rd to the left of T who gets thrice pocket money than F. D and F are not an immediate neighbour. Q and T are immediate neighbours. D gets the pocket money $\frac{2}{3}$ than T. F gets neither 200 nor 300. Q gets twice pocket money than D. After connecting all these information, we get that – F gets 100, T gets 300, D gets 200 and Q gets 400. So, case 2 gets eliminated here.

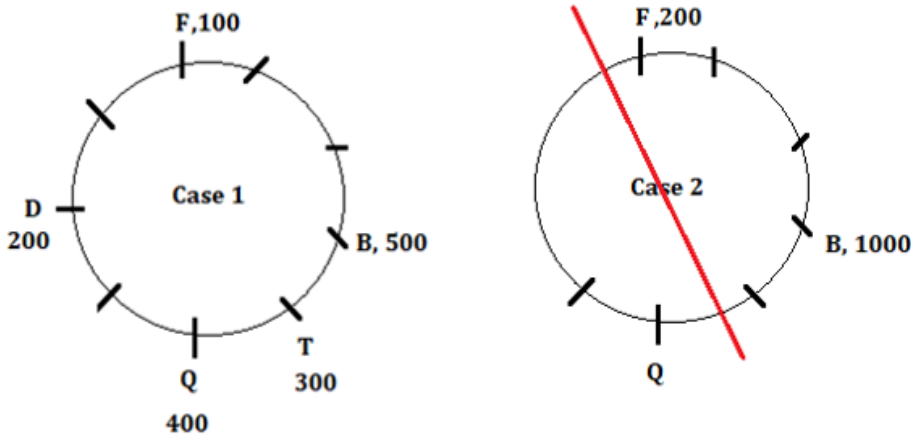

Not more than one person sits between D and F when counted to the right of F. From this condition total number of persons fixed i.e., 9. Sum of the pocket money of B's immediate neighbours is 1000. So, the final arrangement is-

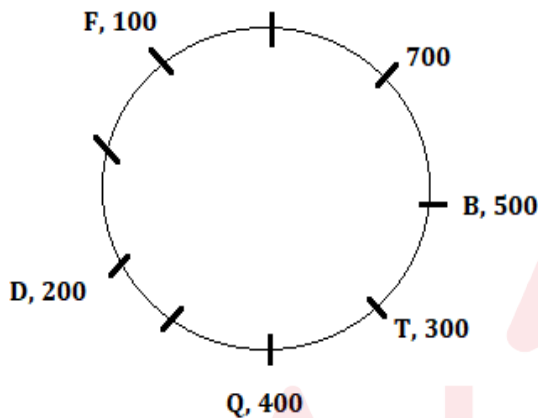

F sits 4th to the right of T

Q37. Which of the following statement is true?

- I. D sits 3rd to the right of the one who gets 700 rupees
 - II. B and T are not immediate neighbours
 - III. D and B are not immediate neighbours
- (a). Only III
 (b). Both I and II
 (c). Only II
 (d). Both I and III
 (e). All I, II and III

Ans.(a)

Sol. From the given statements, each of them gets different pocket money in a multiple of 100 but not more than 1000 which means not more than 10 persons sit around the table. Q sits 2nd to the left of B who gets 5 times of pocket money than F. Here we have 2 possible cases. F sits 3 places away from B. F does not sit near to Q.

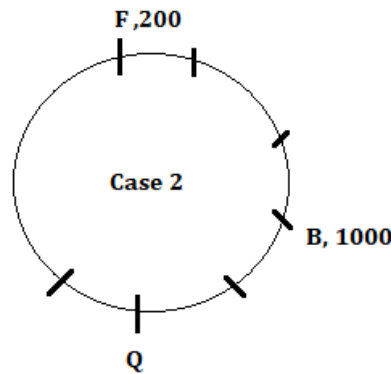
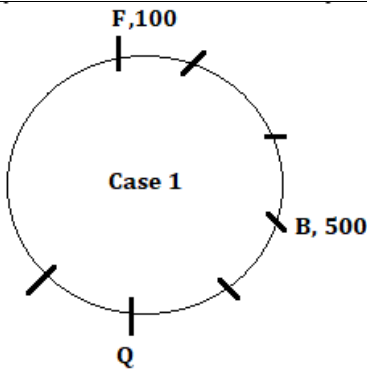

D sits 3rd to the left of T who gets thrice pocket money than F. D and F are not an immediate neighbour. Q and T are immediate neighbours. D gets the pocket money $\frac{2}{3}$ than T. F gets neither 200 nor 300. Q gets twice pocket money than D. After connecting all these information, we get that – F gets 100, T gets 300, D gets 200 and Q gets 400. So, case 2 gets eliminated here.

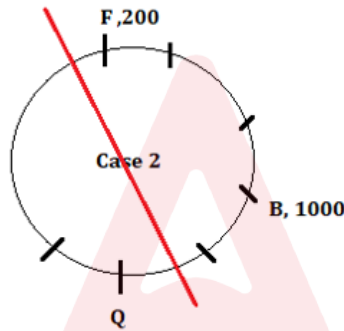
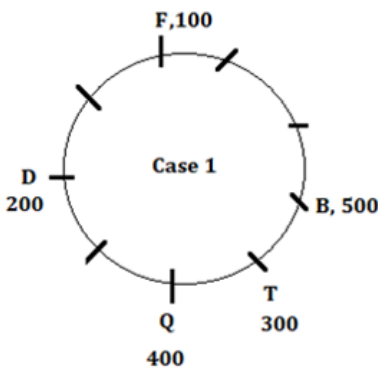

Not more than one person sits between D and F when counted to the right of F. From this condition total number of persons fixed i.e., 9. Sum of the pocket money of B's immediate neighbours is 1000. So, the final arrangement is-

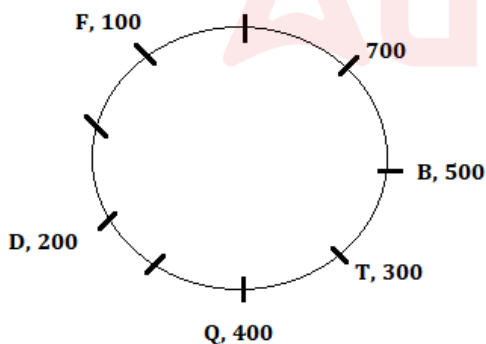

Only statement III is true

Q38. Who among the following gets 400 rupees?

- (a). D
- (b). Q
- (c). T
- (d). Either D or T
- (e). Either Q or T

Ans.(b)

Sol. From the given statements, each of them gets different pocket money in a multiple of 100 but not more than 1000 which means not more than 10 persons sit around the table. Q sits 2nd to the left of B who gets 5 times of pocket money than F. Here we have 2 possible cases. F sits 3 places away from B. F does not sit near to Q.

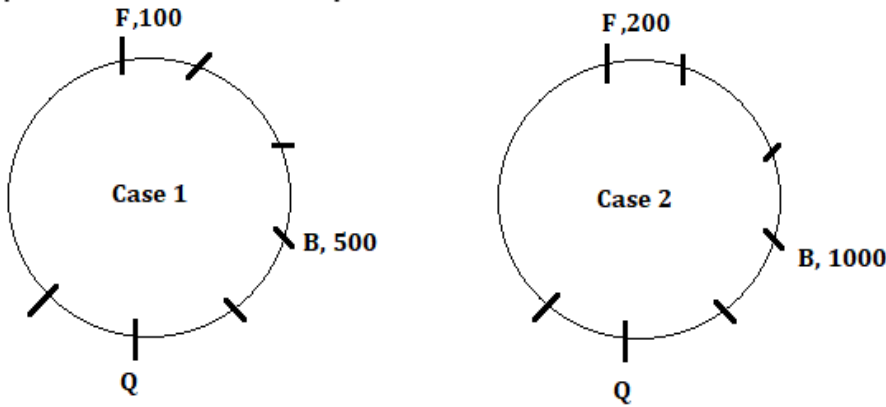

D sits 3rd to the left of T who gets thrice pocket money than F. D and F are not an immediate neighbour. Q and T are immediate neighbours. D gets the pocket money $\frac{2}{3}$ than T. F gets neither 200 nor 300. Q gets twice pocket money than D. After connecting all these information, we get that – F gets 100, T gets 300, D gets 200 and Q gets 400. So, case 2 gets eliminated here.

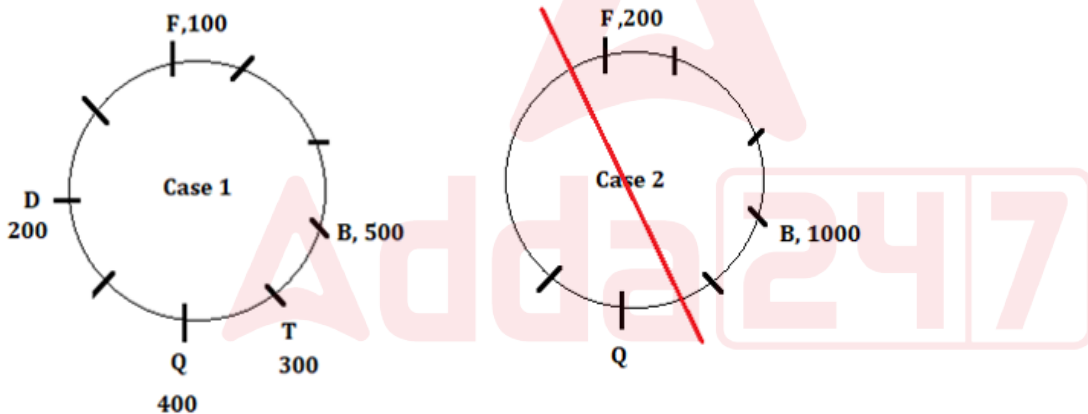

Not more than one person sits between D and F when counted to the right of F. From this condition total number of persons fixed i.e., 9. Sum of the pocket money of B's immediate neighbours is 1000. So, the final arrangement is-

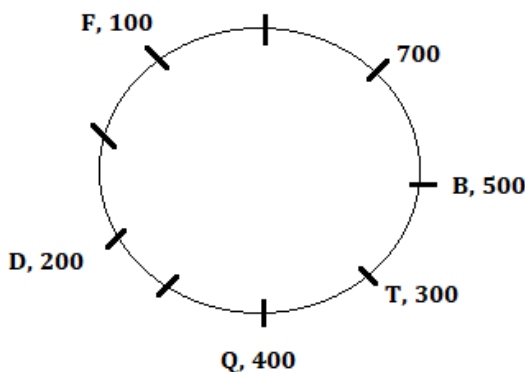

Q gets 400 rupees

Q39. What is the sum of the pocket money of D, B and Q?

- (a). 700
- (b). 900
- (c). 1200
- (d). 1000
- (e). 1100

Ans.(e)

Sol. From the given statements, each of them gets different pocket money in a multiple of 100 but not more than 1000 which means not more than 10 persons sit around the table. Q sits 2nd to the left of B who gets 5 times of pocket money than F. Here we have 2 possible cases. F sits 3 places away from B. F does not sit near to Q.

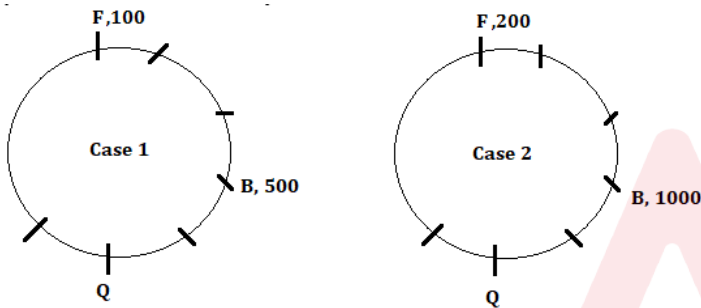

D sits 3rd to the left of T who gets thrice pocket money than F. D and F are not an immediate neighbour. Q and T are immediate neighbours. D gets the pocket money $\frac{2}{3}$ than T. F gets neither 200 nor 300. Q gets twice pocket money than D. After connecting all these information, we get that – F gets 100, T gets 300, D gets 200 and Q gets 400. So, case 2 gets eliminated here.

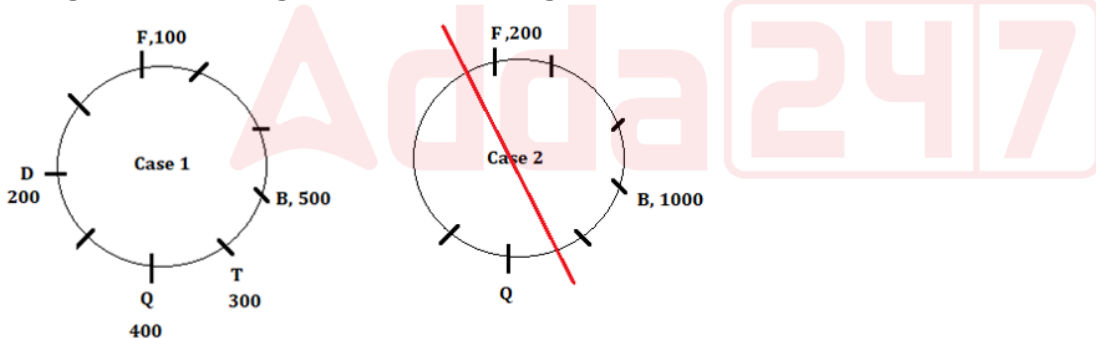

Not more than one person sits between D and F when counted to the right of F. From this condition total number of persons fixed i.e., 9. Sum of the pocket money of B's immediate neighbours is 1000. So, the final arrangement is-

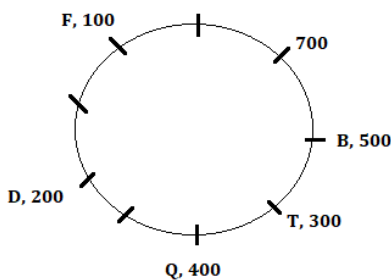

Sum of the pocket money of D (200) + B (500) + Q (400) = 1100

Q40. Pocket money of the person (T + B/F + the one who sits second to the left of F) = ___

- (a). 1100
- (b). 1005
- (c). 3
- (d). 1001
- (e). None of these

Ans.(b)

Sol. From the given statements, each of them gets different pocket money in a multiple of 100 but not more than 1000 which means not more than 10 persons sit around the table. Q sits 2nd to the left of B who gets 5 times of pocket money than F. Here we have 2 possible cases. F sits 3 places away from B. F does not sit near to Q.

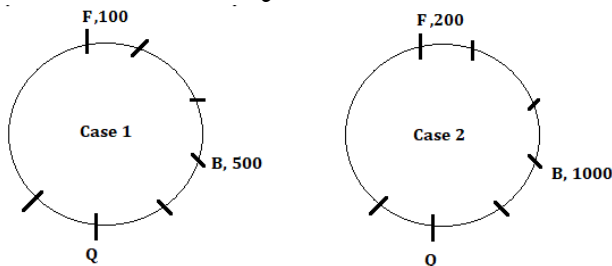

D sits 3rd to the left of T who gets thrice pocket money than F. D and F are not an immediate neighbour. Q and T are immediate neighbours. D gets the pocket money 2/3 than T. F gets neither 200 nor 300. Q gets twice pocket money than D. After connecting all these information, we get that – F gets 100, T gets 300, D gets 200 and Q gets 400. So, case 2 gets eliminated here.

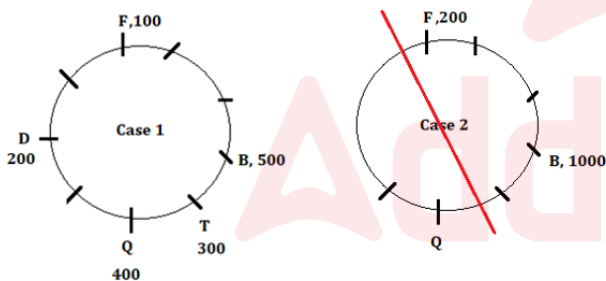

Not more than one person sits between D and F when counted to the right of F. From this condition total number of persons fixed i.e., 9. Sum of the pocket money of B's immediate neighbours is 1000. So, the final arrangement is-

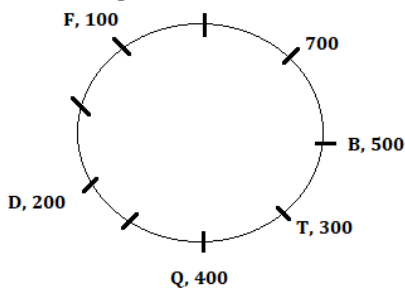

$$(T + B / F + \text{the one who sits 2nd to the left of F}) = (300 + 500 / 100 + 700) = 1005$$

This document has been generated with a trial copy of Javadocx. Please visit the Javadocx website to buy the license that best adapts to your needs.

